

CONGRATULATIONS

Welcome to the ranks of Cessna owners! Your Cessna has been designed and constructed to give you the most in performance, economy, and comfort. It is our desire that you will find flying it, either for business or pleasure, a pleasant and profitable experience.

This Pilot's Operating Handbook has been prepared as a guide to help you get the most pleasure and utility from your airplane. It contains information about your Cessna's equipment, operating procedures, and performance; and suggestions for its servicing and care. We urge you to read it from cover to cover, and to refer to it frequently.

Our interest in your flying pleasure has not ceased with your purchase of a Cessna. World-wide, the Cessna Dealer Organization backed by the Cessna Customer Services Department stands ready to serve you. The following services are offered by most Cessna Dealers:

- THE CESSNA WARRANTY, which provides coverage for parts and labor, is available at Cessna Dealers worldwide. Specific benefits and provisions of warranty, plus other important benefits for you, are contained in your Customer Care Program book, supplied with your airplane. Warranty service is available to you at authorized Cessna Dealers throughout the world upon presentation of your Customer Care Card which establishes your eligibility under the warranty.
- FACTORY TRAINED PERSONNEL to provide you with courteous expert service.
- FACTORY APPROVED SERVICE EQUIPMENT to provide you efficient and accurate workmanship.
- A STOCK OF GENUINE CESSNA SERVICE PARTS on hand when you need them.
- THE LATEST AUTHORITATIVE INFORMATION FOR SERVICING CESSNA AIRPLANES, since Cessna Dealers have all of the Service Manuals and Parts Catalogs, kept current by Service Letters and Service News Letters, published by Cessna Aircraft Company.

We urge all Cessna owners to use the Cessna Dealer Organization to the fullest.

A current Cessna Dealer Directory accompanies your new airplane. The Directory is revised frequently, and a current copy can be obtained from your Cessna Dealer. Make your Directory one of your cross-country flight planning aids; a warm welcome awaits you at every Cessna Dealer.

PERFORMANCE - SPECIFICATIONS

SPEED:

Maximum at Sea Level	133 KNOTS
Cruise, 80% Power at 6000 Ft	130 KNOTS

CRUISE: Recommended lean mixture with fuel allowance for engine start, taxi, takeoff, climb and 45 minutes reserve.

80% Power at 6000 Ft	Range	440 NM
49 Gallons Usable Fuel	Time	3.4 HRS
80% Power at 6000 Ft	Range	635 NM
66 Gallons Usable Fuel	Time	4.9 HRS
Maximum Range at 10,000 Ft	Range	575 NM
49 Gallons Usable Fuel	Time	6.1 HRS
Maximum Range at 10,000 Ft	Range	815 NM
66 Gallons Usable Fuel	Time	8.7 HRS

RATE OF CLIMB AT SEA LEVEL

	870 FPM
--	---------

SERVICE CEILING

	17,000 FT
--	-----------

TAKEOFF PERFORMANCE:

Ground Roll	800 FT
Total Distance Over 50-Ft Obstacle	1360 FT

LANDING PERFORMANCE:

Ground Roll	620 FT
Total Distance Over 50-Ft Obstacle	1270 FT

STALL SPEED (CAS):

Flaps Up, Power Off	53 KNOTS
Flaps Down, Power Off	46 KNOTS

MAXIMUM WEIGHT:

Ramp	2558 LBS
Takeoff or Landing	2550 LBS

STANDARD EMPTY WEIGHT:

Hawk XP	1538 LBS
Hawk XP II	1565 LBS

MAXIMUM USEFUL LOAD:

Hawk XP	1020 LBS
Hawk XP II	993 LBS

BAGGAGE ALLOWANCE

	200 LBS
--	---------

WING LOADING: Pounds/Sq Ft

	14.7
--	------

POWER LOADING: Pounds/HP

	13.1
--	------

FUEL CAPACITY: Total

Standard Tanks	52 GAL.
Long Range Tanks	68 GAL.

OIL CAPACITY

	9 QTS
--	-------

ENGINE: Teledyne Continental, Fuel Injection

	IO-360-KB
--	-----------

195 BHP at 2600 RPM

PROPELLER: Constant Speed, Diameter

	76 IN.
--	--------

COVERAGE

The Pilot's Operating Handbook in the airplane at the time of delivery from Cessna Aircraft Company contains information applicable to the 1980 Model R172K airplane designated by the serial number and registration number shown on the Title Page of this handbook.

REVISIONS

Changes and/or additions to this handbook will be covered by revisions published by Cessna Aircraft Company. These revisions are distributed to all Cessna Dealers and to owners of U. S. Registered aircraft according to FAA records at the time of revision issuance.

Revisions should be examined immediately upon receipt and incorporated in this handbook.

NOTE

It is the responsibility of the owner to maintain this handbook in a current status when it is being used for operational purposes.

Owners should contact their Cessna Dealer whenever the revision status of their handbook is in question.

A revision bar will extend the full length of new or revised text and/or illustrations added on new or presently existing pages. This bar will be located adjacent to the applicable revised area on the outer margin of the page.

All revised pages will carry the revision number and date on the applicable page.

The following Log of Effective Pages provides the dates of issue for original and revised pages, and a listing of all pages in the handbook. Pages affected by the current revision are indicated by an asterisk (*) preceding the pages listed.

LOG OF EFFECTIVE PAGES

Dates of issue for original and revised pages are:

Original 1 July 1979

Page	Date	Page	Date
Title	1 July 1979	5-3 thru 5-27	1 July 1979
Assignment Record	1 July 1979	5-28 Blank	1 July 1979
i thru iv	1 July 1979	6-1	1 July 1979
1-1 thru 1-9	1 July 1979	6-2 Blank	1 July 1979
1-10 Blank	1 July 1979	6-3 thru 6-23	1 July 1979
2-1	1 July 1979	6-24 Blank	1 July 1979
2-2 Blank	1 July 1979	7-1 thru 7-43	1 July 1979
2-3 thru 2-13	1 July 1979	7-44 Blank	1 July 1979
2-14 Blank	1 July 1979	8-1	1 July 1979
3-1 thru 3-9	1 July 1979	8-2 Blank	1 July 1979
3-10 Blank	1 July 1979	8-3 thru 8-17	1 July 1979
3-11 thru 3-18	1 July 1979	8-18 Blank	1 July 1979
4-1 thru 4-11	1 July 1979	9-1 thru 9-2	1 July 1979
4-12 Blank	1 July 1979		
4-13 thru 4-25	1 July 1979		
4-26 Blank	1 July 1979		
5-1	1 July 1979		
5-2 Blank	1 July 1979		

NOTE

Refer to Section 9 Table of Contents for supplements applicable to optional systems.

TABLE OF CONTENTS

	SECTION
GENERAL.....	1
LIMITATIONS.....	2
EMERGENCY PROCEDURES.....	3
NORMAL PROCEDURES.....	4
PERFORMANCE.....	5
WEIGHT & BALANCE/ EQUIPMENT LIST	6
AIRPLANE & SYSTEMS DESCRIPTIONS	7
AIRPLANE HANDLING, SERVICE & MAINTENANCE	8
SUPPLEMENTS (Optional Systems Description & Operating Procedures)	9

SECTION 1 GENERAL

TABLE OF CONTENTS

	Page
Three View	1-2
Introduction	1-3
Descriptive Data	1-3
Engine	1-3
Propeller	1-3
Fuel	1-3
Oil	1-4
Maximum Certificated Weights	1-5
Standard Airplane Weights	1-5
Cabin And Entry Dimensions	1-5
Baggage Space And Entry Dimensions	1-5
Specific Loadings	1-5
Symbols, Abbreviations And Terminology	1-6
General Airspeed Terminology And Symbols	1-6
Meteorological Terminology	1-6
Engine Power Terminology	1-7
Airplane Performance And Flight Planning Terminology	1-7
Weight And Balance Terminology	1-8

SECTION 1
GENERAL

CESSNA
MODEL R172K

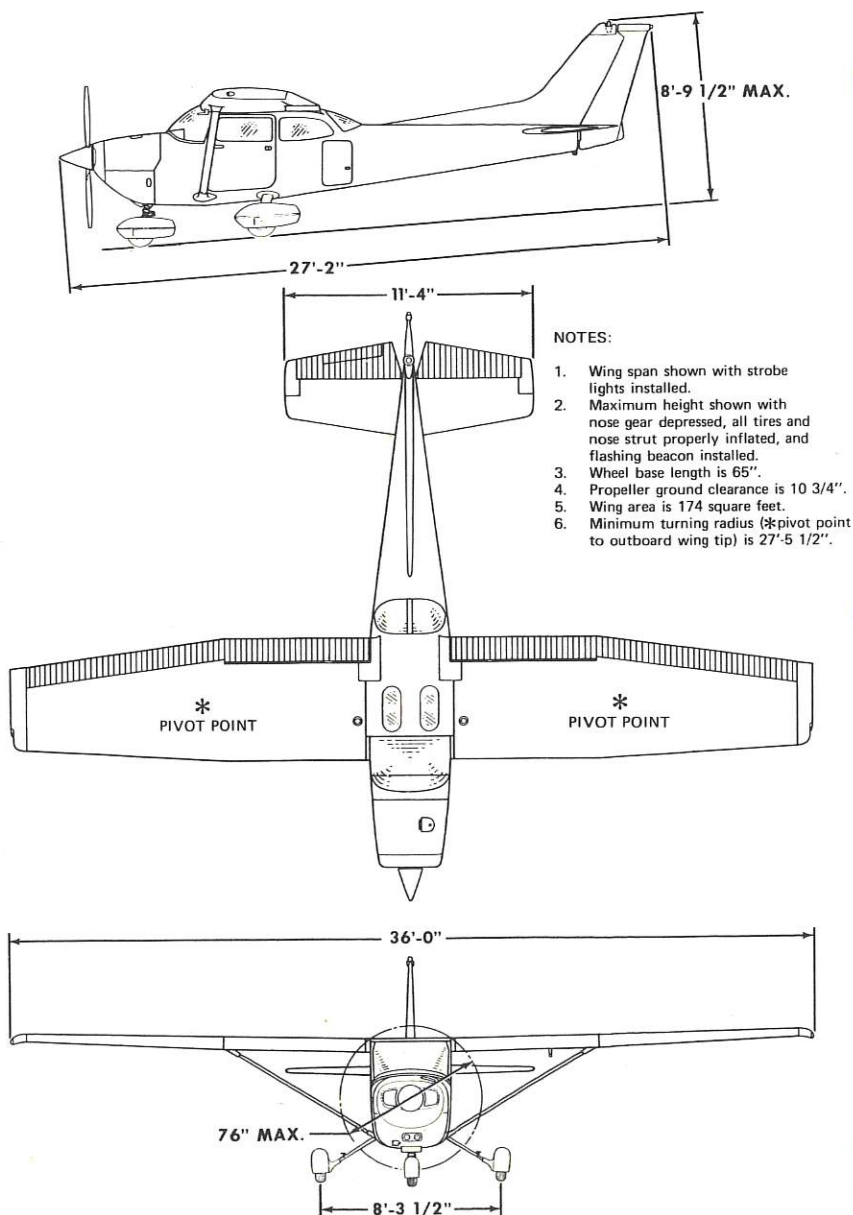

Figure 1-1. Three View

INTRODUCTION

This handbook contains 9 sections, and includes the material required to be furnished to the pilot by CAR Part 3. It also contains supplemental data supplied by Cessna Aircraft Company.

Section 1 provides basic data and information of general interest. It also contains definitions or explanations of symbols, abbreviations, and terminology commonly used.

DESCRIPTIVE DATA

ENGINE

Number of Engines: 1.

Engine Manufacturer: Teledyne Continental.

Engine Model Number: IO-360-KB.

Engine Type: Normally-aspirated, direct-drive, air-cooled, horizontally-opposed, fuel-injected, six-cylinder engine with 360 cu. in. displacement.

Horsepower Rating and Engine Speed: 195 rated BHP at 2600 RPM.

PROPELLER

Propeller Manufacturer: McCauley Accessory Division.

Propeller Model Number: 2A34C203/90DCA-14.

Number of Blades: 2.

Propeller Diameter, Maximum: 76 inches.

Minimum: 74.5 inches.

Propeller Type: Constant speed and hydraulically actuated, with a low pitch setting of 12.0° and a high pitch setting of 25.1° (30 inch station).

FUEL

Approved Fuel Grades (and Colors):

100LL Grade Aviation Fuel (Blue).

100 (Formerly 100/130) Grade Aviation Fuel (Green).

NOTE

Isopropyl alcohol or ethylene glycol monomethyl ether may be added to the fuel supply. Additive concentrations shall not exceed 1% for isopropyl alcohol or .15% for ethylene glycol monomethyl ether. Refer to Section 8 for additional information.

SECTION 1
GENERAL

CESSNA
MODEL R172K

Fuel Capacity:

Standard Tanks:

Total Capacity: 52 gallons.
Total Capacity Each Tank: 26 gallons.
Total Usable: 49 gallons.

Long Range Tanks:

Total Capacity: 68 gallons.
Total Capacity Each Tank: 34 gallons.
Total Usable: 66 gallons.

NOTE

To ensure maximum fuel capacity when refueling and minimize cross-feeding when parked on a sloping surface, place the fuel selector valve in either LEFT or RIGHT position.

OIL

Oil Grade (Specification):

MIL-L-6082 Aviation Grade Straight Mineral Oil: Use to replenish supply during first 25 hours and at the first 25-hour oil change. Continue to use until a total of 50 hours has accumulated or oil consumption has stabilized.

NOTE

The airplane was delivered from the factory with a corrosion preventive aircraft engine oil. This oil should be drained after the first 25 hours of operation.

Continental Motors Specification MHS-24 (and all revisions thereto), Ashless Dispersant Oil: This oil **must be used** after first 50 hours or oil consumption has stabilized.

Recommended Viscosity for Temperature Range:

SAE 20W-50 or SAE 50 above 40°F (4°C).
SAE 20W-50 or SAE 30 below 40°F (4°C).

NOTE

Multi-viscosity oil with a range of SAE 20W-50 is recommended for improved starting in cold weather.

Oil Capacity:

Sump: 8 Quarts.
Total: 9 Quarts.

MAXIMUM CERTIFICATED WEIGHTS

Ramp, Normal Category: 2558 lbs.

Utility Category: 2208 lbs.

Takeoff, Normal Category: 2550 lbs.

Utility Category: 2200 lbs.

Landing, Normal Category: 2550 lbs.

Utility Category: 2200 lbs.

Weight in Baggage Compartment, Normal Category:

Baggage Area 1 or Passenger on Child's Seat - (Baggage, Station 82 to 108, 200 lbs. maximum; Passenger on Child's Seat, 120 lbs. maximum). See note below.

Baggage Area 2 - Station 108 to 142: 50 lbs. See note below.

NOTE

The maximum combined weight capacity for baggage areas 1 and 2 is 200 lbs.

Weight in Baggage Compartment, Utility Category: In this category, the baggage compartment and rear seat must not be occupied.

STANDARD AIRPLANE WEIGHTS

Standard Empty Weight, Hawk XP: 1538 lbs.

Hawk XP II: 1565 lbs.

Maximum Useful Load:

	Normal Category	Utility Category
Hawk XP:	1020 lbs.	670 lbs.
Hawk XP II:	993 lbs.	643 lbs.

CABIN AND ENTRY DIMENSIONS

Detailed dimensions of the cabin interior and entry door openings are illustrated in Section 6.

BAGGAGE SPACE AND ENTRY DIMENSIONS

Dimensions of the baggage area and baggage door opening are illustrated in detail in Section 6.

SPECIFIC LOADINGS

Wing Loading: 14.7 lbs./sq. ft.

Power Loading: 13.1 lbs./hp.

SYMBOLS, ABBREVIATIONS AND TERMINOLOGY

GENERAL AIRSPEED TERMINOLOGY AND SYMBOLS

- KCAS** **Knots Calibrated Airspeed** is indicated airspeed corrected for position and instrument error and expressed in knots. Knots calibrated airspeed is equal to KTAS in standard atmosphere at sea level.
- KIAS** **Knots Indicated Airspeed** is the speed shown on the airspeed indicator and expressed in knots.
- KTAS** **Knots True Airspeed** is the airspeed expressed in knots relative to undisturbed air which is KCAS corrected for altitude and temperature.
- V_A **Maneuvering Speed** is the maximum speed at which you may use abrupt control travel.
- V_{FE} **Maximum Flap Extended Speed** is the highest speed permissible with wing flaps in a prescribed extended position.
- V_{NO} **Maximum Structural Cruising Speed** is the speed that should not be exceeded except in smooth air, then only with caution.
- V_{NE} **Never Exceed Speed** is the speed limit that may not be exceeded at any time.
- V_S **Stalling Speed or the minimum steady flight speed** at which the airplane is controllable.
- V_{S_0} **Stalling Speed or the minimum steady flight speed** at which the airplane is controllable in the landing configuration at the most forward center of gravity.
- V_X **Best Angle-of-Climb Speed** is the speed which results in the greatest gain of altitude in a given horizontal distance.
- V_Y **Best Rate-of-Climb Speed** is the speed which results in the greatest gain in altitude in a given time.

METEOROLOGICAL TERMINOLOGY

- OAT** **Outside Air Temperature** is the free air static temperature.

It is expressed in either degrees Celsius or degrees Fahrenheit.

Standard Temperature	Standard Temperature is 15°C at sea level pressure altitude and decreases by 2°C for each 1000 feet of altitude.
Pressure Altitude	Pressure Altitude is the altitude read from an altimeter when the altimeter's barometric scale has been set to 29.92 inches of mercury (1013 mb).

ENGINE POWER TERMINOLOGY

BHP	Brake Horsepower is the power developed by the engine.
RPM	Revolutions Per Minute is engine speed.
MP	Manifold Pressure is a pressure measured in the engine's induction system and is expressed in inches of mercury (Hg).

AIRPLANE PERFORMANCE AND FLIGHT PLANNING TERMINOLOGY

Demonstrated Crosswind Velocity	Demonstrated Crosswind Velocity is the velocity of the crosswind component for which adequate control of the airplane during takeoff and landing was actually demonstrated during certification tests. The value shown is not considered to be limiting.
Usable Fuel	Usable Fuel is the fuel available for flight planning.
Unusable Fuel	Unusable Fuel is the quantity of fuel that can not be safely used in flight.
GPH	Gallons Per Hour is the amount of fuel (in gallons) consumed per hour.
NMPG	Nautical Miles Per Gallon is the distance (in nautical miles) which can be expected per gallon of fuel consumed at a specific engine power setting and/or flight configuration.
g	g is acceleration due to gravity.

WEIGHT AND BALANCE TERMINOLOGY

Reference Datum	Reference Datum is an imaginary vertical plane from which all horizontal distances are measured for balance purposes.
Station	Station is a location along the airplane fuselage given in terms of the distance from the reference datum.
Arm	Arm is the horizontal distance from the reference datum to the center of gravity (C.G.) of an item.
Moment	Moment is the product of the weight of an item multiplied by its arm. (Moment divided by the constant 1000 is used in this handbook to simplify balance calculations by reducing the number of digits.)
Center of Gravity (C.G.)	Center of Gravity is the point at which an airplane, or equipment, would balance if suspended. Its distance from the reference datum is found by dividing the total moment by the total weight of the airplane.
C.G. Arm	Center of Gravity Arm is the arm obtained by adding the airplane's individual moments and dividing the sum by the total weight.
C.G. Limits	Center of Gravity Limits are the extreme center of gravity locations within which the airplane must be operated at a given weight.
Standard Empty Weight	Standard Empty Weight is the weight of a standard airplane, including unusable fuel, full operating fluids and full engine oil.
Basic Empty Weight	Basic Empty Weight is the standard empty weight plus the weight of optional equipment.
Useful Load	Useful Load is the difference between ramp weight and the basic empty weight.
Maximum Ramp Weight	Maximum Ramp Weight is the maximum weight approved for ground maneuver. (It includes the weight of start, taxi and runup fuel.)
Maximum Takeoff Weight	Maximum Takeoff Weight is the maximum weight approved for the start of the takeoff run.

Maximum
Landing
Weight

Maximum Landing Weight is the maximum weight approved for the landing touchdown.

Tare

Tare is the weight of chocks, blocks, stands, etc. used when weighing an airplane, and is included in the scale readings. Tare is deducted from the scale reading to obtain the actual (net) airplane weight.

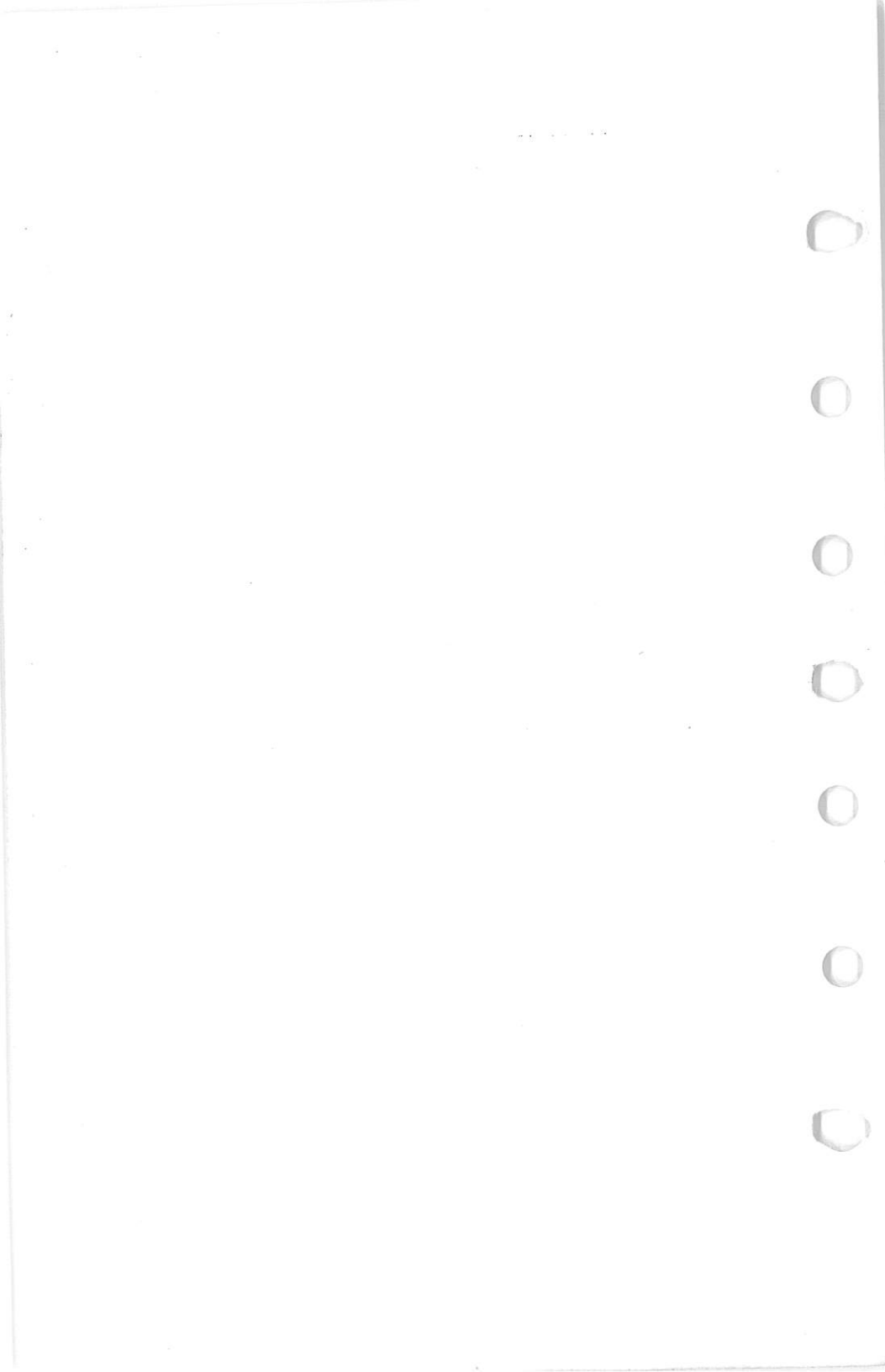

SECTION 2 LIMITATIONS

TABLE OF CONTENTS

	Page
Introduction	2-3
Airspeed Limitations	2-4
Airspeed Indicator Markings	2-5
Power Plant Limitations	2-5
Power Plant Instrument Markings	2-6
Weight Limits	2-6
Normal Category	2-6
Utility Category	2-7
Center Of Gravity Limits	2-7
Normal Category	2-7
Utility Category	2-7
Maneuver Limits	2-7
Normal Category	2-7
Utility Category	2-8
Flight Load Factor Limits	2-8
Normal Category	2-8
Utility Category	2-8
Kinds Of Operation Limits	2-9
Fuel Limitations	2-9
Other Limitations	2-9
Flap Limitations	2-9
Placards	2-10



AIRPEED INDICATOR MARKINGS

Airspeed indicator markings and their color code significance are shown in figure 2-2.

MARKING	KIAS VALUE OR RANGE	SIGNIFICANCE
White Arc	38 - 85	Full Flap Operating Range. Lower limit is maximum weight V_{SO} in landing configuration. Upper limit is maximum speed permissible with flaps extended.
Green Arc	48 - 129	Normal Operating Range. Lower limit is maximum weight V_S at most forward C.G. with flaps retracted. Upper limit is maximum structural cruising speed.
Yellow Arc	129 - 163	Operations must be conducted with caution and only in smooth air.
Red Line	163	Maximum speed for all operations.

Figure 2-2. Airspeed Indicator Markings

POWER PLANT LIMITATIONS

Engine Manufacturer: Teledyne Continental.

Engine Model Number: IO-360-KB.

Engine Operating Limits for Takeoff and Continuous Operations:

Maximum Power: 195 BHP rating.

Maximum Engine Speed: 2600 RPM.

Maximum Cylinder Head Temperature: 460°F (238°C).

Maximum Oil Temperature: 240°F (116°C).

Oil Pressure, Minimum: 10 psi.

Maximum: 100 psi.

Fuel Pressure, Minimum: 3 psi.

Maximum: 17 psi (17 gal/hr).

Propeller Manufacturer: McCauley Accessory Division.

Propeller Model Number: 2A34C203/90DCA-14.

Propeller Diameter, Maximum: 76 inches.

Minimum: 74.5 inches.

Propeller Blade Angle at 30 Inch Station, Low: 12.0°.

High: 25.1°.

POWER PLANT INSTRUMENT MARKINGS

Power plant instrument markings and their color code significance are shown in figure 2-3.

INSTRUMENT	RED LINE	GREEN ARC	RED LINE
	MINIMUM LIMIT	NORMAL OPERATING	MAXIMUM LIMIT
Tachometer	---	2200 - 2600 RPM	2600 RPM
Manifold Pressure	---	15 - 25 in. Hg	---
Oil Temperature	---	100° - 240°F	240°F
Cylinder Head Temperature	---	200° - 460°F	460°F
Fuel Flow (Pressure)	(3 psi)	4.5 - 11.5 gal/hr	17 gal/hr (17 psi)
Oil Pressure	10 psi	30 - 60 psi	100 psi
Fuel Quantity (Standard Tanks)	E (1.5 Gal. Unusable Each Tank)	---	---
Fuel Quantity (Long Range Tanks)	E (1.0 Gal. Unusable Each Tank)	---	---
Suction	---	4.5 - 5.4 in. Hg.	---

Figure 2-3. Power Plant Instrument Markings

WEIGHT LIMITS

NORMAL CATEGORY

Maximum Ramp Weight: 2558 lbs.
Maximum Takeoff Weight: 2550 lbs.
Maximum Landing Weight: 2550 lbs.

Maximum Weight in Baggage Compartment:

Baggage Area 1 or Passenger on Child's Seat - (Baggage, Station 82 to 108, 200 lbs. maximum; Passenger on Child's Seat 120 lbs. maximum). See note below.

Baggage Area 2 - Station 108 to 142: 50 lbs. See note below.

NOTE

The maximum combined weight capacity for baggage areas 1 and 2 is 200 lbs.

UTILITY CATEGORY

Maximum Ramp Weight: 2208 lbs.

Maximum Takeoff Weight: 2200 lbs.

Maximum Landing Weight: 2200 lbs.

Maximum Weight in Baggage Compartment: In the utility category, the baggage compartment and rear seat must not be occupied.

CENTER OF GRAVITY LIMITS

NORMAL CATEGORY

Center of Gravity Range:

Forward: 35.0 inches aft of datum at 1950 lbs. or less, with straight line variation to 41.0 inches aft of datum at 2550 lbs.

Aft: 47.3 inches aft of datum at all weights.

Reference Datum: Lower portion of front face of firewall.

UTILITY CATEGORY

Center of Gravity Range:

Forward: 35.0 inches aft of datum at 1950 lbs. or less, with straight line variation to 37.5 inches aft of datum at 2200 lbs.

Aft: 40.5 inches aft of datum at all weights.

Reference Datum: Lower portion of front face of firewall.

MANEUVER LIMITS

NORMAL CATEGORY

This airplane is certificated in both the normal and utility category. The normal category is applicable to aircraft intended for non-aerobatic operations. These include any maneuvers incidental to normal flying, stalls (except whip stalls), lazy eights, chandelles, and turns in which the angle of bank is not more than 60°. Aerobatic maneuvers, including spins, are not approved.

UTILITY CATEGORY

This airplane is not designed for purely aerobatic flight. However, in the acquisition of various certificates such as commercial pilot and flight instructor, certain maneuvers are required by the FAA. All of these maneuvers are permitted in this airplane when operated in the utility category.

In the utility category, the baggage compartment and rear seat must not be occupied. No aerobatic maneuvers are approved except those listed below:

MANEUVER	RECOMMENDED ENTRY SPEED*
Chandelles	110 knots
Lazy Eights	110 knots
Steep Turns	104 knots
Spins	Slow Deceleration
Stalls (Except Whip Stalls)	Slow Deceleration

*Abrupt use of the controls is prohibited above 104 knots.

Aerobatics that may impose high loads should not be attempted. The important thing to bear in mind in flight maneuvers is that the airplane is clean in aerodynamic design and will build up speed quickly with the nose down. Proper speed control is an essential requirement for execution of any maneuver, and care should always be exercised to avoid excessive speed which in turn can impose excessive loads. In the execution of all maneuvers, avoid abrupt use of controls. Intentional spins with flaps extended are prohibited.

FLIGHT LOAD FACTOR LIMITS

NORMAL CATEGORY

Flight Load Factors (Maximum Takeoff Weight - 2550 lbs.):

- *Flaps Up +3.8g, -1.52g
- *Flaps Down +3.0g

*The design load factors are 150% of the above, and in all cases, the structure meets or exceeds design loads.

UTILITY CATEGORY

Flight Load Factors (Maximum Takeoff Weight - 2200 lbs.):

- *Flaps Up +4.4g, -1.76g
- *Flaps Down +3.0g

*The design load factors are 150% of the above, and in all cases, the structure meets or exceeds design loads.

KINDS OF OPERATION LIMITS

The airplane is equipped for day VFR and may be equipped for night VFR and/or IFR operations. FAR Part 91 establishes the minimum required instrumentation and equipment for these operations. The reference to types of flight operations on the operating limitations placard reflects equipment installed at the time of Airworthiness Certificate issuance.

Flight into known icing conditions is prohibited.

FUEL LIMITATIONS

2 Standard Tanks: 26 U.S. gallons each.

Total Fuel: 52 U.S. gallons.

Usable Fuel (all flight conditions): 49 U.S. gallons.

Unusable Fuel: 3 U.S. gallons.

2 Long Range Tanks: 34 U.S. gallons each.

Total Fuel: 68 U.S. gallons.

Usable Fuel (all flight conditions): 66 U.S. gallons.

Unusable Fuel: 2 U.S. gallons.

NOTE

To ensure maximum fuel capacity when refueling and minimize cross-feeding when parked on a sloping surface, place the fuel selector valve in either LEFT or RIGHT position.

Fuel remaining in the tank after the fuel quantity indicator reads empty (red line) cannot be safely used in flight.

Approved Fuel Grades (and Colors):

100LL Grade Aviation Fuel (Blue).

100 (Formerly 100/130) Grade Aviation Fuel (Green).

OTHER LIMITATIONS

FLAP LIMITATIONS

Approved Takeoff Range: 0° to 15°.

Approved Landing Range: 0° to 40°.

PLACARDS

The following information must be displayed in the form of composite or individual placards.

1. In full view of the pilot: (The "DAY-NIGHT-VFR-IFR" entry, shown on the example below, will vary as the airplane is equipped.)

The markings and placards installed in this airplane contain operating limitations which must be complied with when operating this airplane in the Normal Category. Other operating limitations which must be complied with when operating this airplane in this category or in the Utility Category are contained in the Pilot's Operating Handbook and FAA Approved Airplane Flight Manual.

Normal Category - No acrobatic maneuvers, including spins, approved.

Utility Category - No acrobatic maneuvers approved, except those listed in the Pilot's Operating Handbook.

Baggage compartment and rear seat must not be occupied.

Spin Recovery - Opposite rudder - forward elevator - neutralize controls.

Flight into known icing conditions prohibited.

This airplane is certified for the following flight operations as of date of original airworthiness certificate:

DAY-NIGHT-VFR-IFR

2. Near wing flap switch:

AVOID SLIPS WITH FLAPS EXTENDED

3. On the fuel selector plate (standard tanks):

BOTH - 49 GAL.
LEFT - 24.5 GAL.
RIGHT - 24.5 GAL.
WHEN SWITCHING FROM DRY TANK
TURN PUMP ON "HI" MOMENTARILY

- On the fuel selector plate (long range tanks):

BOTH - 66 GAL.
LEFT - 33 GAL.
RIGHT - 33 GAL.
WHEN SWITCHING FROM DRY TANK
TURN PUMP ON "HI" MOMENTARILY

4. Near fuel tank filler cap (standard tanks):

FUEL
100LL/100 MIN. GRADE AVIATION GASOLINE
CAP. 26 U.S. GAL.

- Near fuel tank filler cap (long range tanks):

FUEL
100LL/100 MIN. GRADE AVIATION GASOLINE
CAP. 34.0 U.S. GAL.
CAP. 26.0 U.S. GAL. TO BOTTOM OF FILLER COLLAR

5. On control lock:

CONTROL LOCK
REMOVE BEFORE STARTING ENGINE.

6. In baggage compartment:

200 POUNDS MAXIMUM
BAGGAGE OR 120 LBS AUX SEAT PASSENGER
FORWARD OF BAGGAGE DOOR LATCH

50 POUNDS MAXIMUM
BAGGAGE AFT OF BAGGAGE DOOR LATCH

MAXIMUM 200 POUNDS COMBINED

FOR ADDITIONAL LOADING INSTRUCTIONS
SEE WEIGHT AND BALANCE DATA

7. Near manifold pressure/fuel flow gage:

FUEL FLOW
AT FULL THROTTLE

	2600 RPM
SL.....	16 GPH
4000 FT.....	14 GPH
8000 FT.....	12 GPH
12000 FT.....	10 GPH

8. A calibration card is provided to indicate the accuracy of the magnetic compass in 30° increments.

9. On the flap control indicator:

0° to 10°	(Partial flap range with blue color code and 110 kt callout; also, mechanical detent at 10°.)
10° to 40°	(Indices at these positions with white color code and 85 kt callout; also, mechanical detent at 20°.)

10. Near the airspeed indicator:

MANEUVER SPEED
104 KIAS

11. On the oil filler cap:

OIL
8 QTS

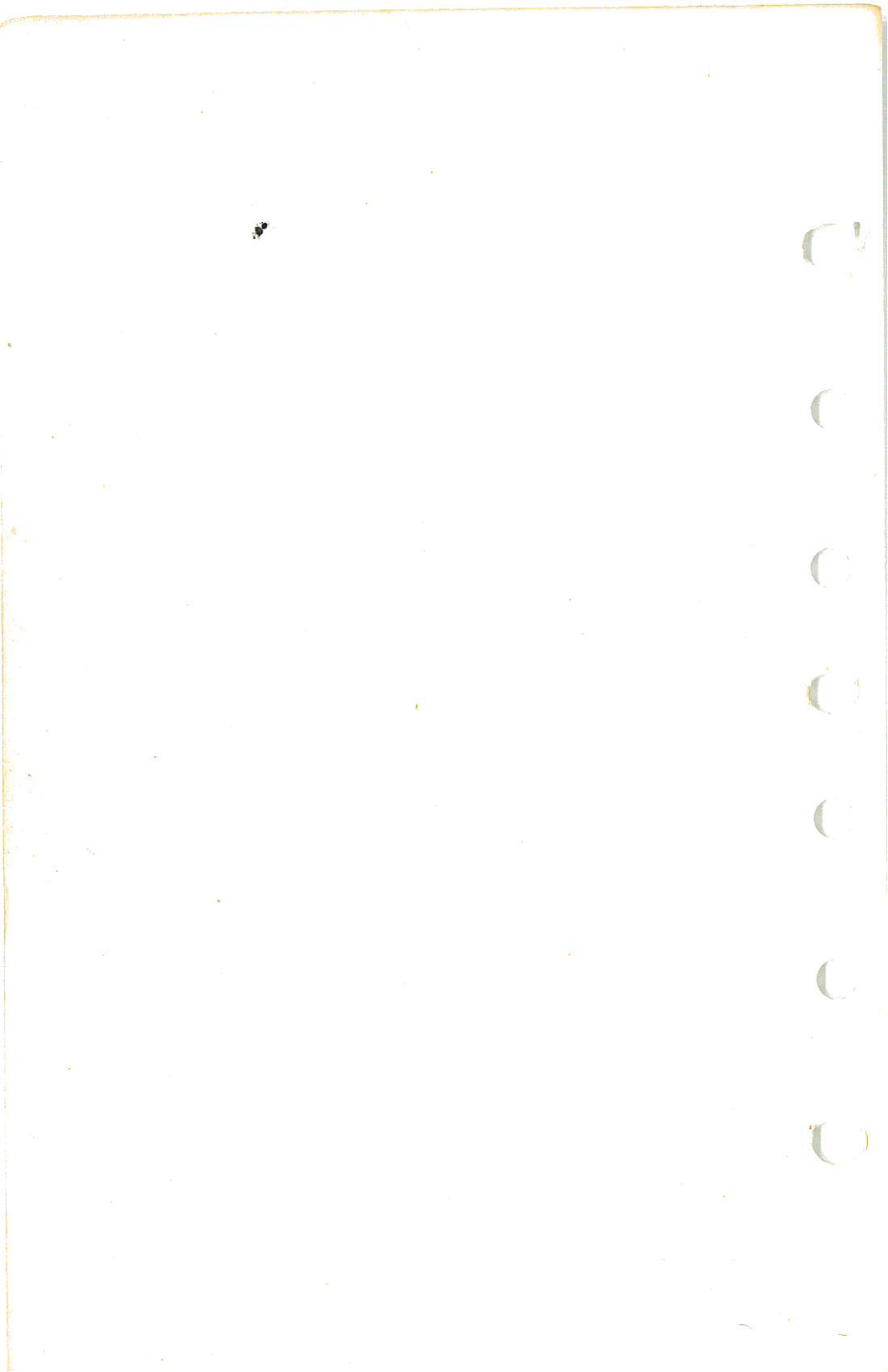

SECTION 3 EMERGENCY PROCEDURES

TABLE OF CONTENTS

	Page
Introduction	3-3
Airspeeds For Emergency Operation	3-3

OPERATIONAL CHECKLISTS

Engine Failures	3-3
Engine Failure During Takeoff Run	3-3
Engine Failure Immediately After Takeoff	3-4
Engine Failure During Flight	3-4
Forced Landings	3-4
Emergency Landing Without Engine Power	3-4
Precautionary Landing With Engine Power	3-4
Ditching	3-5
Fires	3-5
During Start On Ground	3-5
Engine Fire In Flight	3-6
Electrical Fire In Flight	3-6
Cabin Fire	3-7
Wing Fire	3-7
Icing	3-7
Inadvertent Icing Encounter	3-7
Static Source Blockage (Erroneous Instrument Reading Suspected)	3-8
Landing With A Flat Main Tire	3-8
Electrical Power Supply System Malfunctions	3-8
Ammeter Shows Excessive Rate of Charge (Full Scale Deflection)	3-8
Low-Voltage Light Illuminates During Flight (Ammeter Indicates Discharge)	3-9

AMPLIFIED PROCEDURES

Engine Failure	3-11
Forced Landings	3-12
Landing Without Elevator Control	3-12
Fires	3-12

TABLE OF CONTENTS (Continued)

	Page
Emergency Operation In Clouds (Vacuum System Failure)	3-13
Executing A 180° Turn In Clouds	3-13
Emergency Descent Through Clouds	3-13
Recovery From A Spiral Dive	3-14
Inadvertent Flight Into Icing Conditions	3-14
Static Source Blocked	3-15
Spins	3-15
Rough Engine Operation Or Loss Of Power	3-16
Spark Plug Fouling	3-16
Magneto Malfunction	3-16
Engine-Driven Fuel Pump Failure	3-16
Low Oil Pressure	3-17
Electrical Power Supply System Malfunctions	3-17
Excessive Rate Of Charge	3-18
Insufficient Rate Of Charge	3-18

INTRODUCTION

Section 3 provides checklist and amplified procedures for coping with emergencies that may occur. Emergencies caused by airplane or engine malfunctions are extremely rare if proper preflight inspections and maintenance are practiced. Enroute weather emergencies can be minimized or eliminated by careful flight planning and good judgment when unexpected weather is encountered. However, should an emergency arise, the basic guidelines described in this section should be considered and applied as necessary to correct the problem. Emergency procedures associated with ELT and other optional systems can be found in Section 9.

AIRSPEDS FOR EMERGENCY OPERATION

Engine Failure After Takeoff:

Wing Flaps Up	70 KIAS
Wing Flaps Down	65 KIAS

Maneuvering Speed:

2550 Lbs	104 KIAS
2150 Lbs	95 KIAS
1750 Lbs	85 KIAS

Maximum Glide:

2550 Lbs	75 KIAS
2150 Lbs	69 KIAS
1750 Lbs	62 KIAS

Precautionary Landing With Engine Power 65 KIAS

Landing Without Engine Power:

Wing Flaps Up	70 KIAS
Wing Flaps Down	65 KIAS

OPERATIONAL CHECKLISTS

ENGINE FAILURES

ENGINE FAILURE DURING TAKEOFF RUN

1. Throttle -- IDLE.
2. Brakes -- APPLY.
3. Wing Flaps -- RETRACT.
4. Mixture -- IDLE CUT-OFF.

**SECTION 3
EMERGENCY PROCEDURES**

**CESSNA
MODEL R172K**

5. Ignition Switch -- OFF.
6. Master Switch -- OFF.

ENGINE FAILURE IMMEDIATELY AFTER TAKEOFF

1. Airspeed -- 70 KIAS (flaps UP).
65 KIAS (flaps DOWN).
2. Mixture -- IDLE CUT-OFF.
3. Fuel Shutoff Valve -- OFF (pull out).
4. Ignition Switch -- OFF.
5. Wing Flaps -- AS REQUIRED (full down recommended).
6. Master Switch -- OFF.

ENGINE FAILURE DURING FLIGHT

1. Airspeed -- 75 KIAS.
2. Primer -- IN and LOCKED.
3. Fuel Shutoff Valve -- ON (push full in).
4. Fuel Selector Valve -- BOTH.
5. Mixture -- RICH.
6. Throttle -- 1/2 OPEN.
7. Auxiliary Fuel Pump -- LOW for 3-5 seconds then OFF.
8. Ignition Switch -- BOTH (or START if propeller is stopped).

FORCED LANDINGS

EMERGENCY LANDING WITHOUT ENGINE POWER

1. Airspeed -- 70 KIAS (flaps UP).
65 KIAS (flaps DOWN).
2. Seat Belts and Shoulder Harnesses -- SECURE.
3. Mixture -- IDLE CUT-OFF.
4. Fuel Shutoff Valve -- OFF.
5. All Switches (except master switch) -- OFF.
6. Wing Flaps -- AS REQUIRED (full down recommended).
7. Master Switch -- OFF.
8. Doors -- UNLATCH PRIOR TO TOUCHDOWN.
9. Touchdown -- SLIGHTLY TAIL LOW.
10. Brakes -- APPLY HEAVILY.

PRECAUTIONARY LANDING WITH ENGINE POWER

1. Seat Belts and Shoulder Harnesses -- SECURE.
2. Wing Flaps -- 20°.
3. Airspeed -- 65 KIAS.

4. Selected Field -- FLY OVER, noting terrain and obstructions, then retract flaps upon reaching a safe altitude and airspeed.
5. Avionics Power Switch and Electrical Switches -- OFF.
6. Wing Flaps -- FULL DOWN (on final approach).
7. Airspeed -- 65 KIAS.
8. Master Switch -- OFF.
9. Doors -- UNLATCH PRIOR TO TOUCHDOWN.
10. Touchdown -- SLIGHTLY TAIL LOW.
11. Ignition Switch -- OFF.
12. Brakes -- APPLY HEAVILY.

DITCHING

1. Radio -- TRANSMIT MAYDAY on 121.5 MHz, giving location and intentions and SQUAWK 7700 if transponder is installed.
2. Heavy Objects (in baggage area) -- SECURE OR JETTISON.
3. Seat Belts and Shoulder Harnesses -- SECURE .
4. Wing Flaps -- 20° - 40°.
5. Power -- ESTABLISH 300 FT/MIN DESCENT AT 55 KIAS.
6. Approach -- High Winds, Heavy Seas -- INTO THE WIND.
Light Winds, Heavy Swells -- PARALLEL TO SWELLS.

NOTE

If no power is available, approach at 65 KIAS with flaps up -
or at 60 KIAS with 10° flaps.

7. Cabin Doors -- UNLATCH.
8. Face -- CUSHION at touchdown with folded coat.
9. Touchdown -- LEVEL ATTITUDE AT ESTABLISHED RATE OF DESCENT.
10. Airplane -- EVACUATE through cabin doors. If necessary, open window and flood cabin to equalize pressure so doors can be opened.
11. Life Vests and Raft -- INFLATE.

FIRES

DURING START ON GROUND

1. Auxiliary Fuel Pump -- OFF.
2. Mixture -- IDLE CUT-OFF.
3. Parking Brake -- RELEASE.

4. Fire Extinguisher -- OBTAIN (have ground attendants obtain if not installed).
5. Airplane -- EVACUATE.
6. Fire -- EXTINGUISH.

NOTE

If sufficient ground personnel are available (and fire is on ground and not too dangerous) move airplane away from the fire by pushing rearward on the leading edge of the horizontal stabilizer.

7. Fire Damage -- INSPECT, repair damage or replace damaged components or wiring before conducting another flight.

ENGINE FIRE IN FLIGHT

1. Throttle -- CLOSE.
2. Mixture -- IDLE CUT-OFF.
3. Fuel Shutoff Valve -- OFF.
4. Master Switch -- OFF.
5. Cabin Heat and Air -- OFF (except overhead vents).
6. Airspeed -- 105 KIAS (If fire is not extinguished, increase glide speed to find an airspeed which will provide an incombustible mixture).
7. Forced Landing -- EXECUTE (as described in Emergency Landing Without Engine Power).

ELECTRICAL FIRE IN FLIGHT

1. Master Switch -- OFF.
2. Avionics Power Switch -- OFF.
3. All Other Switches (except ignition switch) -- OFF.
4. Vents/Cabin Air/Heat -- CLOSED.
5. Fire Extinguisher -- ACTIVATE (if available).

WARNING

After discharging an extinguisher within a closed cabin, ventilate the cabin.

If fire appears out and electrical power is necessary for continuance of flight:

6. Master Switch -- ON.

LOW-VOLTAGE LIGHT ILLUMINATES DURING FLIGHT (Ammeter Indicates Discharge)

NOTE

Illumination of the low-voltage light may occur during low RPM conditions with an electrical load on the system such as during a low RPM taxi. Under these conditions, the light will go out at higher RPM. The master switch need not be recycled since an over-voltage condition has not occurred to de-activate the alternator system.

1. Avionics Power Switch -- OFF.
2. Alternator Circuit Breaker -- CHECK IN.
3. Master Switch -- OFF (both sides).
4. Master Switch -- ON.
5. Low-Voltage Light -- CHECK OFF.
6. Avionics Power Switch -- ON.

If low-voltage light illuminates again:

7. Alternator -- OFF.
8. Nonessential Radio and Electrical Equipment -- OFF.
9. Flight -- TERMINATE as soon as practical.



AMPLIFIED PROCEDURES

ENGINE FAILURE

If an engine failure occurs during the takeoff run, the most important thing to do is stop the airplane on the remaining runway. Those extra items on the checklist will provide added safety after a failure of this type.

Prompt lowering of the nose to maintain airspeed and establish a glide attitude is the first response to an engine failure after takeoff. In most cases, the landing should be planned straight ahead with only small changes in direction to avoid obstructions. Altitude and airspeed are seldom sufficient to execute a 180° gliding turn necessary to return to the runway. The checklist procedures assume that adequate time exists to secure the fuel and ignition systems prior to touchdown.

After an engine failure in flight, the best glide speed as shown in figure 3-1 should be established as quickly as possible. While gliding toward a suitable landing area, an effort should be made to identify the cause of the failure. If time permits, an engine restart should be attempted as shown in the checklist. If the engine cannot be restarted, a forced landing without power must be completed.

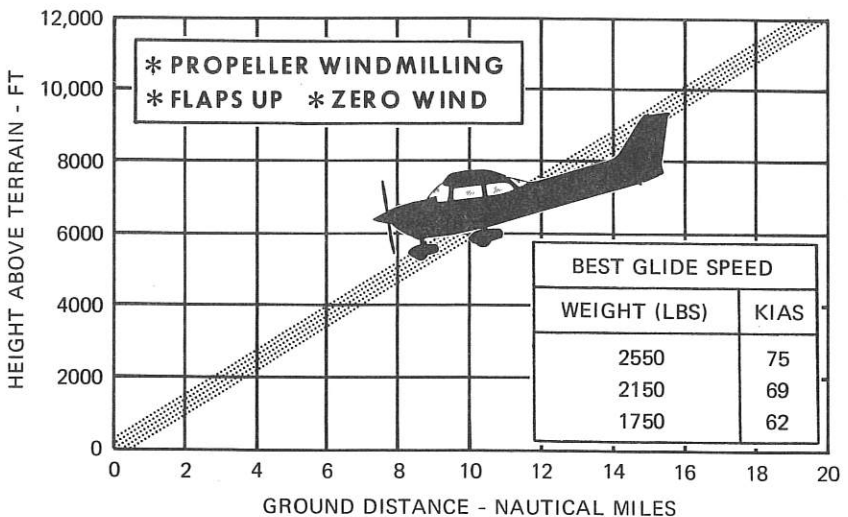

Figure 3-1. Maximum Glide

FORCED LANDINGS

If all attempts to restart the engine fail and a forced landing is imminent, select a suitable field and prepare for the landing as discussed under the Emergency Landing Without Engine Power checklist.

Before attempting an "off airport" landing with engine power available, one should fly over the landing area at a safe but low altitude to inspect the terrain for obstructions and surface conditions, proceeding as discussed under the Precautionary Landing With Engine Power checklist.

Prepare for ditching by securing or jettisoning heavy objects located in the baggage area and collect folded coats for protection of occupants' face at touchdown. Transmit Mayday message on 121.5 MHz giving location and intentions and squawk 7700 if a transponder is installed. Avoid a landing flare because of difficulty in judging height over a water surface.

LANDING WITHOUT ELEVATOR CONTROL

Trim for horizontal flight to an airspeed of approximately 65 KIAS with flaps set to 20° by using throttle and elevator trim control. Then **do not change the elevator trim control setting**; control the glide angle by adjusting power exclusively.

At flareout, the nose-down moment resulting from power reduction is an adverse factor and the airplane may hit on the nose wheel. Consequently, at flareout, the elevator trim control should be adjusted toward the full nose-up position and the power adjusted so that the airplane will rotate to the horizontal attitude for touchdown. Close the throttle at touchdown.

FIRES

Improper starting procedures involving the excessive use of auxiliary fuel pump operation can cause engine flooding and subsequent puddling of fuel on the parking ramp as the excess fuel drains overboard from the intake ports. This is sometimes experienced in difficult starts in cold weather where preheat service is not available. If this occurs, the airplane should be pushed away from the fuel puddle before another engine start is attempted. Otherwise, there is a possibility of raw fuel accumulations in the exhaust system igniting during an engine start, causing a long flame from the tailpipe, and possibly igniting the fuel puddle on the pavement. In the event that this occurs, proceed in accordance with the Fire During Start On Ground checklist.

Although engine fires are extremely rare in flight, the steps of the appropriate checklist should be followed if one is encountered. After completion of this procedure, execute a forced landing as soon as possible. Do not attempt to restart the engine.

The initial indication of an electrical fire is usually the odor of burning insulation. The checklist for this problem should result in elimination of the fire.

EMERGENCY OPERATION IN CLOUDS

(Vacuum System Failure)

In the event of a vacuum system failure during flight, the directional indicator and attitude indicator will be disabled, and the pilot will have to rely on the turn coordinator if he inadvertently flies into clouds. The following instructions assume that only the electrically-powered turn coordinator is operative, and that the pilot is not completely proficient in instrument flying.

EXECUTING A 180° TURN IN CLOUDS

Upon inadvertently entering the clouds, an immediate plan should be made to turn back as follows:

1. Note the compass heading.
2. Note the time of the minute hand and observe the position of the sweep second hand on the clock.
3. When the sweep second hand indicates the nearest half-minute, initiate a standard rate left turn, holding the turn coordinator symbolic airplane wing opposite the lower left index mark for 60 seconds. Then roll back to level flight by leveling the miniature airplane.
4. Check accuracy of the turn by observing the compass heading which should be the reciprocal of the original heading.
5. If necessary, adjust heading primarily with skidding motions rather than rolling motions so that the compass will read more accurately.
6. Maintain altitude and airspeed by cautious application of elevator control. Avoid overcontrolling by keeping the hands off the control wheel as much as possible and steering only with rudder.

EMERGENCY DESCENT THROUGH CLOUDS

If conditions preclude reestablishment of VFR flight by a 180° turn, a descent through a cloud deck to VFR conditions may be appropriate. If

possible, obtain radio clearance for an emergency descent through clouds. To guard against a spiral dive, choose an easterly or westerly heading to minimize compass card swings due to changing bank angles. In addition, keep hands off the control wheel and steer a straight course with rudder control by monitoring the turn coordinator. Occasionally check the compass heading and make minor corrections to hold an approximate course. Before descending into the clouds, set up a stabilized let-down condition as follows:

1. Reduce power to set up a 500 to 800 ft/min rate of descent.
2. Adjust mixture as required for smooth engine operation.
3. Adjust the elevator trim and rudder trim for a stabilized descent at 75 KIAS.
4. Keep hands off the control wheel.
5. Monitor turn coordinator and make corrections by rudder alone.
6. Adjust rudder trim to relieve unbalanced rudder force, if present.
7. Check trend of compass card movement and make cautious corrections with rudder to stop the turn.
8. Upon breaking out of clouds, resume normal cruising flight.

RECOVERY FROM A SPIRAL DIVE

If a spiral is encountered, proceed as follows:

1. Close the throttle.
2. Stop the turn by using coordinated aileron and rudder control to align the symbolic airplane in the turn coordinator with the horizon reference line.
3. Cautiously apply elevator back pressure to slowly reduce the airspeed to 75 KIAS.
4. Adjust the elevator trim control to maintain a 75 KIAS glide.
5. Keep hands off the control wheel, using rudder control to hold a straight heading. Use rudder trim to relieve unbalanced rudder force, if present.
6. Clear engine occasionally, but avoid using enough power to disturb the trimmed glide.
7. Upon breaking out of clouds, resume normal cruising flight.

INADVERTENT FLIGHT INTO ICING CONDITIONS

Intentional flight into known icing conditions is prohibited in this airplane. During instrument flight; however, icing conditions may be encountered inadvertently and therefore some corrective action will be required as shown in the checklists. Initiation of a climb is usually the best ice avoidance action to take; however, alternatives are descent to warmer air or to reverse course.

STATIC SOURCE BLOCKED

If erroneous instrument readings are suspected due to water, ice, or other foreign matter in the pressure lines going to the standard external static pressure sources, the alternate static source valve should be pulled on.

A calibration table is provided in Section 5 to illustrate the effect of the alternate static source on indicated airspeeds. With the windows and vents closed the airspeed indicator may typically read as much as 4 knots slower and the altimeter 50 feet lower in cruise. With the vents open and heater on, these variations increase to 7 knots slower and 50 feet lower respectively. If the alternate static source must be used for landing, airspeed errors of up to 10 knots slower with vents open and 4 knots slower with vents closed can be expected. Altimeter errors remain 50 feet low.

NOTE

In an emergency on airplanes not equipped with an alternate static source, cabin pressure can be supplied to the static pressure instruments by breaking the glass in the face of the rate-of-climb indicator.

SPINS

Should an inadvertent spin occur, the following recovery procedure should be used:

1. RETARD THROTTLE TO IDLE POSITION.
2. PLACE AILERONS IN NEUTRAL POSITION.
3. APPLY AND **HOLD** FULL RUDDER OPPOSITE TO THE DIRECTION OF ROTATION.
4. **JUST AFTER** THE RUDDER REACHES THE STOP, MOVE THE CONTROL WHEEL **BRISKLY** FORWARD FAR ENOUGH TO BREAK THE STALL. Full down elevator may be required at aft center of gravity loadings to assure optimum recoveries.
5. **HOLD** THESE CONTROL INPUTS UNTIL ROTATION STOPS. Premature relaxation of the control inputs may extend the recovery.
6. **AS** ROTATION STOPS, NEUTRALIZE RUDDER, AND MAKE A SMOOTH RECOVERY FROM THE RESULTING DIVE.

NOTE

If disorientation precludes a visual determination of the direction of rotation, the symbolic airplane in the turn coordinator may be referred to for this information.

For additional information on spins and spin recovery, see the discussion under SPINS in Normal Procedures (Section 4).

ROUGH ENGINE OPERATION OR LOSS OF POWER

SPARK PLUG FOULING

A slight engine roughness in flight may be caused by one or more spark plugs becoming fouled by carbon or lead deposits. This may be verified by turning the ignition switch momentarily from BOTH to either L or R position. An obvious power loss in single ignition operation is evidence of spark plug or magneto trouble. Assuming that spark plugs are the more likely cause, lean the mixture to the recommended lean setting for cruising flight. If the problem does not clear up in several minutes, determine if a richer mixture setting will produce smoother operation. If not, proceed to the nearest airport for repairs using the BOTH position of the ignition switch unless extreme roughness dictates the use of a single ignition position.

MAGNETO MALFUNCTION

A sudden engine roughness or misfiring is usually evidence of magneto problems. Switching from BOTH to either L or R ignition switch position will identify which magneto is malfunctioning. Select different power settings and enrichen the mixture to determine if continued operation on BOTH magnetos is practicable. If not, switch to the good magneto and proceed to the nearest airport for repairs.

If ignition system malfunctions occur at high altitude and high power, as evidenced by roughness and possible backfiring on one or both magnetos, the power should be reduced as required. This condition is an indication of excessive spark plug gaps which, in turn, causes arcing across the magneto points.

ENGINE-DRIVEN FUEL PUMP FAILURE

Failure of the engine-driven fuel pump will be evidenced by a sudden reduction in the fuel flow indication prior to a loss of power, while operating with adequate fuel in either or both fuel tanks.

In the event of an engine-driven fuel pump failure during takeoff, immediately **hold** the auxiliary fuel pump switch in the HIGH position until the airplane is well clear of obstacles. Upon reaching a safe altitude, and reducing power to cruise settings, releasing the switch to the LOW position will then provide sufficient fuel flow to maintain engine operation while maneuvering for a landing.

If an engine-driven fuel pump failure occurs during cruising flight, apply full rich mixture and **hold** the auxiliary fuel pump switch in the HIGH position to re-establish fuel flow. Then the LOW position of the fuel pump switch may be used to sustain level flight. If necessary, additional fuel flow is obtainable by holding the pump switch in the HIGH position. If either LOW or HIGH fuel pump switch positions results in rough engine operation lean the mixture as required for smooth operation.

LOW OIL PRESSURE

If low oil pressure is accompanied by normal oil temperature, there is a possibility the oil pressure gage or relief valve is malfunctioning. A leak in the line to the gage is not necessarily cause for an immediate precautionary landing because an orifice in this line will prevent a sudden loss of oil from the engine sump. However, a landing at the nearest airport would be advisable to inspect the source of trouble.

If a total loss of oil pressure is accompanied by a rise in oil temperature, there is good reason to suspect an engine failure is imminent. Reduce engine power immediately and select a suitable forced landing field. Use only the minimum power required to reach the desired touchdown spot.

ELECTRICAL POWER SUPPLY SYSTEM MALFUNCTIONS

Malfunctions in the electrical power supply system can be detected by periodic monitoring of the ammeter and low-voltage warning light; however, the cause of these malfunctions is usually difficult to determine. Broken or loose alternator wiring is most likely the cause of alternator failures, although other factors could cause the problem. A damaged or improperly adjusted alternator control unit can also cause malfunctions. Problems of this nature constitute an electrical emergency and should be dealt with immediately. Electrical power malfunctions usually fall into two categories: excessive rate of charge and insufficient rate of charge. The following paragraphs describe the recommended remedy for each situation.

EXCESSIVE RATE OF CHARGE

After engine starting and heavy electrical usage at low engine speeds (such as extended taxiing) the battery condition will be low enough to accept above normal charging during the initial part of a flight. However, after thirty minutes of cruising flight, the ammeter should be indicating less than two needle widths of charging current. If the charging rate were to remain above this value on a long flight, the battery would overheat and evaporate the electrolyte at an excessive rate.

Electronic components in the electrical system can be adversely affected by higher than normal voltage. The alternator control unit includes an over-voltage sensor which normally will automatically shut down the alternator if the charge voltage reaches approximately 31.5 volts. If the over-voltage sensor malfunctions or is improperly adjusted, as evidenced by an excessive rate of charge shown on the ammeter, the alternator should be turned off, alternator circuit breaker pulled, nonessential electrical equipment turned off and the flight terminated as soon as practical.

INSUFFICIENT RATE OF CHARGE

NOTE

Illumination of the low-voltage light and ammeter discharge indications may occur during low RPM conditions with an electrical load on the system, such as during a low RPM taxi. Under these conditions, the light will go out at higher RPM. The master switch need not be recycled since an over-voltage condition has not occurred to de-activate the alternator system.

If the over-voltage sensor should shut down the alternator, or if the alternator circuit breaker should trip, a discharge rate will be shown on the ammeter followed by illumination of the low-voltage warning light. Since this may be a "nuisance" trip-out, an attempt should be made to reactivate the alternator system. To do this, turn the avionics power switch off, check that the alternator circuit breaker is in, then turn both sides of the master switch off and then on again. If the problem no longer exists, normal alternator charging will resume and the low-voltage light will go off. The avionics power switch may then be turned back on. If the light illuminates again, a malfunction is confirmed. In this event, the flight should be terminated and/or the current drain on the battery minimized because the battery can supply the electrical system for only a limited period of time. If the emergency occurs at night, power must be conserved for later use of the landing lights and flaps during landing.

SECTION 4

NORMAL PROCEDURES

TABLE OF CONTENTS

	Page
Introduction	4-3
Speeds For Normal Operation	4-3

CHECKLIST PROCEDURES

Preflight Inspection	4-5
Cabin	4-5
Empennage	4-5
Right Wing, Trailing Edge	4-5
Right Wing	4-5
Nose	4-6
Left Wing	4-6
Left Wing, Leading Edge	4-6
Left Wing, Trailing Edge	4-7
Before Starting Engine	4-7
Starting Engine	4-7
Before Takeoff	4-8
Takeoff	4-8
Normal Takeoff	4-8
Short Field Takeoff	4-8
Enroute Climb	4-9
Normal Climb	4-9
Maximum Performance Climb	4-9
Cruise	4-9
Descent	4-9
Before Landing	4-9
Landing	4-10
Normal Landing	4-10
Short Field Landing	4-10
Balked Landing	4-10
After Landing	4-10
Securing Airplane	4-10

AMPLIFIED PROCEDURES

Starting Engine	4-13
---------------------------	------

TABLE OF CONTENTS (Continued)

	Page
Taxiing	4-15
Before Takeoff	4-15
Warm-Up	4-15
Magneto Check	4-15
Alternator Check	4-16
Takeoff	4-16
Power Check	4-16
Wing Flap Settings	4-17
Crosswind Takeoff	4-17
Enroute Climb	4-17
Cruise	4-18
Leaning With A Cessna Economy Mixture Indicator (EGT)	4-19
Stalls	4-20
Spins	4-20
Landing	4-22
Normal Landing	4-22
Short Field Landing	4-22
Crosswind Landing	4-22
Balked Landing	4-23
Cold Weather Operation	4-23
Starting	4-23
Warm-Up	4-24
Inflight	4-24
Hot Weather Operation	4-24
Noise Abatement	4-24

INTRODUCTION

Section 4 provides checklist and amplified procedures for the conduct of normal operation. Normal procedures associated with optional systems can be found in Section 9.

SPEEDS FOR NORMAL OPERATION

Unless otherwise noted, the following speeds are based on a maximum weight of 2550 pounds and may be used for any lesser weight. However, to achieve the performance specified in Section 5 for takeoff distance, the speed appropriate to the particular weight must be used.

Takeoff, Flaps Up:

Normal Climb Out	75-85 KIAS
Short Field Takeoff, Flaps 10°, Speed at 50 Feet	58 KIAS

Enroute Climb, Flaps Up:

Normal	85-95 KIAS
Best Rate of Climb, Sea Level	78 KIAS
Best Rate of Climb, 10,000 Feet	73 KIAS
Best Angle of Climb, Sea Level	57 KIAS
Best Angle of Climb, 10,000 Feet	63 KIAS

Landing Approach:

Normal Approach, Flaps Up	65-75 KIAS
Normal Approach, Flaps 40°	60-70 KIAS
Short Field Approach, Flaps 40°	* 60 KIAS

Balked Landing:

Maximum Power, Flaps 20°	55 KIAS
------------------------------------	---------

Maximum Recommended Turbulent Air Penetration Speed:

2550 Lbs	104 KIAS
2150 Lbs	95 KIAS
1750 Lbs	85 KIAS

Maximum Demonstrated Crosswind Velocity:

Takeoff and Landing	20 KNOTS
-------------------------------	----------

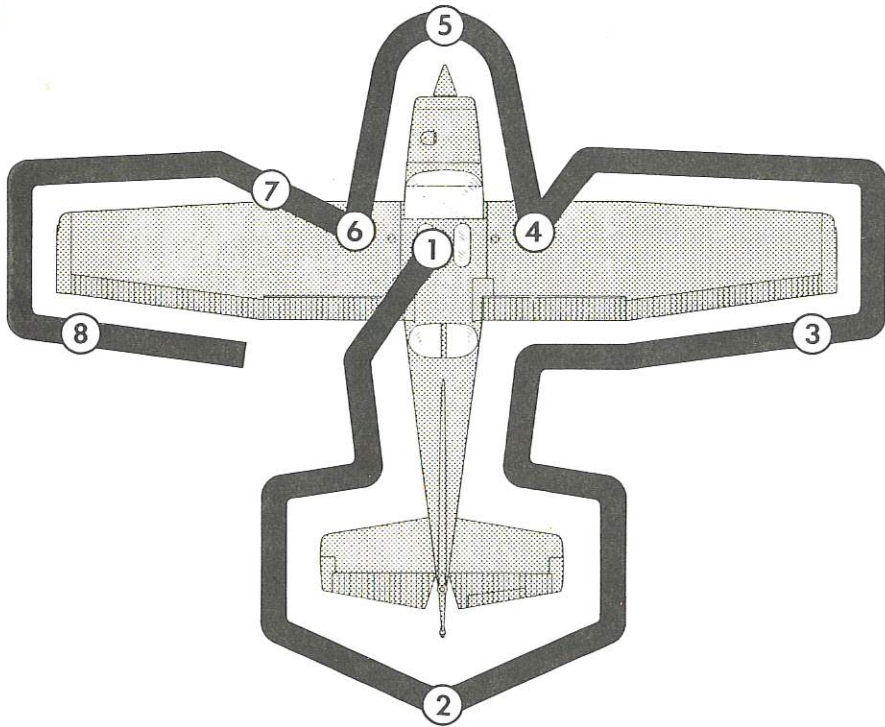

NOTE

Visually check airplane for general condition during walk-around inspection. In cold weather, remove even small accumulations of frost, ice or snow from wing, tail and control surfaces. Also, make sure that control surfaces contain no internal accumulations of ice or debris. Prior to flight, check that pitot heater (if installed) is warm to touch within 30 seconds with battery and pitot switches on. If a night flight is planned, check operation of all lights, and make sure a flashlight is available.

Figure 4-1. Preflight Inspection

APPENDIX 86-19-11

PILOT OPERATING PROCEDURES-PREFLIGHT FUEL SYSTEM CHECK

Fuel sampling: Fuel strainer, wing tank and reservoir quick drains.

1. Place a suitable container under the fuel strainer drain outlet prior to operating the strainer drain control for at least 4 seconds. Check strainer drain closed

2. Inspect the fluid drained from the fuel strainer and each wing tank quick drain for evidence of fuel contamination in the form of water, rust, sludge, ice or any other substance not compatible with fuel. Also check for proper fuel grade before the first flight of each day and after each refueling. If any contamination is detected, comply with 4 below.

3. Repeat Steps 1 and 2 on each wing tank quick drain.

4. If the airplane has been exposed to rain, sleet or snow, or if the wing fuel tanks or fuel strainer drains produce water, the fuel reservoir(s) must be checked for the presence of water by operating the fuel reservoir quick drains. The airplane fuel system must be purged to the extent necessary to insure that there is no water, ice or other fuel contamination.

NOTE 1: The fuel reservoir(s) are located under the fuselage between the firewall and forward door post on all airplane models. Consult the Pilots Operating Handbook or Owners Manual in order to determine if one or two reservoir(s) are installed.

NOTE 2: A check for the presence of water using the fuel reservoir quick drains prior to the first flight of each day is considered good operating practice.



CHECKLIST PROCEDURES

PREFLIGHT INSPECTION

① CABIN

1. Pilot's Operating Handbook -- AVAILABLE IN THE AIRPLANE.
2. Control Wheel Lock -- REMOVE and STOW.
3. Ignition Switch -- OFF.
4. Avionics Power Switch -- OFF.
5. Master Switch -- ON.

WARNING

When turning on the master switch, using an external power source, or pulling the propeller through by hand, treat the propeller as if the ignition switch were on. Do not stand, nor allow anyone else to stand, within the arc of the propeller, since a loose or broken wire, or a component malfunction, could cause the propeller to rotate.

6. Fuel Quantity Indicators -- CHECK QUANTITY.
7. Master Switch -- OFF.
8. Fuel Shutoff Valve -- ON (push full in).
9. Fuel Selector Valve -- BOTH.
10. Trim Controls -- NEUTRAL.
11. Static Pressure Alternate Source Valve (if installed) -- OFF.
12. Baggage Door -- CHECK for security, lock with key if child's seat is to be occupied.

② EMPENNAGE

1. Rudder Gust Lock -- REMOVE.
2. Tail Tie-Down -- DISCONNECT.
3. Control Surfaces -- CHECK freedom of movement and security.

③ RIGHT WING Trailing Edge

1. Aileron -- CHECK freedom of movement and security.

④ RIGHT WING

1. Wing Tie-Down -- DISCONNECT.

SECTION 4
NORMAL PROCEDURES

CESSNA
MODEL R172K

2. Main Wheel Tire -- CHECK for proper inflation.
3. Before first flight of the day and after each refueling, use sampler cup and drain small quantity of fuel from fuel tank sump quick-drain valve to check for water, sediment, and proper fuel grade.
4. Fuel Quantity -- CHECK VISUALLY for desired level.
5. Fuel Filler Cap -- SECURE.

⑤ NOSE

1. Before first flight of the day and after each refueling, use sampler cup and drain small quantity of fuel from fuel reservoir quick-drain valve to check for water, sediment, and proper fuel grade.
2. Static Source Openings (both sides of fuselage) -- CHECK for stoppage.
3. Propeller and Spinner -- CHECK for nicks, security and oil leaks.
4. Landing Lights -- CHECK for condition and cleanliness.
5. Nose Wheel Strut and Tire -- CHECK for proper inflation.
6. Nose Tie-Down -- DISCONNECT.
7. Engine Oil Level -- CHECK. Do not operate with less than six quarts. Fill to eight quarts for extended flight.
8. Before first flight of the day and after each refueling, pull out strainer drain knob for about four seconds to clear fuel strainer of possible water and sediment. Check strainer drain closed. If water is observed, the fuel system may contain additional water, and further draining of the system at the strainer, fuel tank sumps, reservoir drain valve and fuel selector drain plug will be necessary.

⑥ LEFT WING

1. Main Wheel Tire -- CHECK for proper inflation.
2. Before first flight of day and after each refueling, use sampler cup and drain small quantity of fuel from fuel tank sump quick-drain valve to check for water, sediment and proper fuel grade.
3. Fuel Quantity -- CHECK VISUALLY for desired level.
4. Fuel Filler Cap -- SECURE.

⑦ LEFT WING Leading Edge

1. Pitot Tube Cover -- REMOVE and check opening for stoppage.
2. Fuel Tank Vent Opening -- CHECK for stoppage.
3. Stall Warning Opening -- CHECK for stoppage. To check the system, place a clean handkerchief over the vent opening and apply suction; a sound from the horn will confirm system operation.
4. Wing Tie-Down -- DISCONNECT.

8 LEFT WING Trailing Edge

1. Aileron -- CHECK freedom of movement and security.

BEFORE STARTING ENGINE

1. Preflight Inspection -- COMPLETE.
2. Seats, Belts, Shoulder Harnesses -- ADJUST and LOCK.
3. Fuel Shutoff Valve -- ON (push full in).
4. Fuel Selector Valve -- BOTH.
5. Avionics Power Switch, Autopilot (if installed), Electrical Equipment -- OFF.

CAUTION

The avionics power switch must be OFF during engine start to prevent possible damage to avionics.

6. Brakes -- TEST and SET.
7. Cowl Flap -- OPEN (move lever inboard out of locking hole to reposition).
8. Circuit Breakers -- CHECK IN.

STARTING ENGINE

1. Mixture -- RICH.
2. Propeller -- HIGH RPM.
3. Throttle -- CLOSED.
4. Master Switch -- ON.
5. Auxiliary Fuel Pump Switch -- HIGH.
6. Throttle -- ADVANCE to obtain 8-10 GPH fuel flow then return to CLOSED position.
7. Auxiliary Fuel Pump Switch -- OFF.
8. Propeller Area -- CLEAR.
9. Ignition Switch -- START (release to BOTH when engine starts).

NOTE

The engine should start in two to three revolutions. If it does not continue running, start again at step 3 above. If the engine does not start, leave the auxiliary fuel pump switch off, set the mixture to idle cut-off, open the throttle, and crank until the engine fires (or for approximately 15

SECTION 4
NORMAL PROCEDURES

CESSNA
MODEL R17~~K~~

seconds). If still unsuccessful, start again using the normal starting procedure after allowing the starter motor to cool.

10. Throttle -- 800 to 1000 RPM.
11. Oil Pressure -- CHECK.
12. Flashing Beacon and Navigation Lights -- ON as required.
13. Avionics Power Switch -- ON.
14. Radios -- ON.

BEFORE TAKEOFF

1. Parking Brake -- SET.
2. Cabin Doors -- CLOSED and LOCKED.
3. Flight Controls -- FREE and CORRECT.
4. Flight Instruments -- SET.
5. Fuel Selector Valve -- BOTH.
6. Elevator and Rudder Trim -- SET.
7. Throttle -- 1800 RPM.
 - a. Magnetos -- CHECK (RPM drop should not exceed 150 RPM on either magneto or 50 RPM differential between magnetos).
 - b. Propeller -- CYCLE from high to low RPM; return to high RPM (full in).
 - c. Engine Instruments and Ammeter -- CHECK.
 - d. Suction Gage -- CHECK (4.5 to 5.4 In. Hg.).
 - e. Throttle -- 1000 RPM or less.
8. Radios -- SET.
9. Autopilot (if installed) -- OFF.
10. Strobe Lights -- AS DESIRED.
11. Throttle Friction Lock -- ADJUST.
12. Brakes -- RELEASE.

TAKEOFF

NORMAL TAKEOFF

1. Wing Flaps -- 0°- 10° (10° preferred).
2. Power -- FULL THROTTLE and 2600 RPM.
3. Mixture -- LEAN for field elevation per fuel flow placard.
4. Elevator Control -- LIFT NOSE WHEEL at 55 KIAS.
5. Climb Speed -- 75-85 KIAS.

SHORT FIELD TAKEOFF

1. Wing Flaps -- 10°.

2. Brakes -- APPLY.
3. Power -- FULL THROTTLE and 2600 RPM.
4. Mixture -- LEAN for field elevation per fuel flow placard.
5. Brakes -- RELEASE.
6. Elevator Control -- MAINTAIN SLIGHTLY TAIL-LOW ATTITUDE.
7. Climb Speed -- 58 KIAS (until all obstacles are cleared).
8. Wing Flaps -- RETRACT after obstacles are cleared.

ENROUTE CLIMB

NORMAL CLIMB

1. Airspeed -- 85-95 KIAS.
2. Power -- FULL THROTTLE and 2600 RPM.
3. Fuel Selector Valve -- BOTH.
4. Mixture -- LEAN for altitude per fuel flow placard.
5. Cowl Flap -- OPEN as required.

MAXIMUM PERFORMANCE CLIMB

1. Airspeed -- 78 KIAS at sea level to 73 KIAS at 10,000 feet.
2. Power -- FULL THROTTLE and 2600 RPM.
3. Fuel Selector Valve -- BOTH.
4. Mixture -- LEAN for altitude per fuel flow placard.
5. Cowl Flap -- OPEN.

CRUISE

1. Power -- 15-25 INCHES Hg, 2200-2600 RPM (no more than 80% power).
2. Elevator and Rudder Trim -- ADJUST.
3. Mixture -- LEAN for cruise fuel flow using the EGT gage, Cessna Power Computer or the data in Section 5.
4. Cowl Flap -- CLOSED.

DESCENT

1. Fuel Selector Valve -- BOTH.
2. Power -- AS DESIRED.
3. Mixture -- ENRICHEN as required for engine smoothness.
4. Cowl Flap -- CLOSED.

BEFORE LANDING

1. Seats, Belts, Shoulder Harnesses -- ADJUST and LOCK.
2. Fuel Selector Valve -- BOTH.

**SECTION 4
NORMAL PROCEDURES**

**CESSNA
MODEL R172K**

3. Propeller -- HIGH RPM.
4. Cowl Flap -- CLOSED.
5. Autopilot (if installed) -- OFF.

LANDING

NORMAL LANDING

1. Airspeed -- 65-75 KIAS (flaps UP).
2. Wing Flaps -- AS DESIRED (0° - 10° below 110 KIAS, 10° - 40° below 85 KIAS).
3. Airspeed -- 60-70 KIAS (flaps DOWN).
4. Elevator and Rudder Trim -- ADJUST.
5. Touchdown -- MAIN WHEELS FIRST.
6. Landing Roll -- LOWER NOSE WHEEL GENTLY.
7. Braking -- MINIMUM REQUIRED.

SHORT FIELD LANDING

1. Airspeed -- 65-75 KIAS (flaps UP).
2. Wing Flaps -- FULL DOWN (below 85 KIAS).
3. Airspeed -- MAINTAIN 60 KIAS.
4. Elevator and Rudder Trim -- ADJUST.
5. Power -- REDUCE TO IDLE as obstacle is cleared.
6. Touchdown -- MAIN WHEELS FIRST.
7. Brakes -- APPLY HEAVILY.
8. Wing Flaps -- RETRACT for maximum brake effectiveness.

BALKED LANDING

1. Power -- FULL THROTTLE and 2600 RPM.
2. Wing Flaps -- RETRACT to 20°.
3. Airspeed -- 55 KIAS.
4. Wing Flaps -- RETRACT slowly after reaching 65 KIAS.
5. Cowl Flap -- OPEN.

AFTER LANDING

1. Wing Flaps -- RETRACT.
2. Cowl Flap -- OPEN.

SECURING AIRPLANE

1. Parking Brake -- SET.
2. Avionics Power Switch, Autopilot (if installed), Electrical Equipment -- OFF.
3. Throttle -- IDLE.

4. Mixture -- IDLE CUT-OFF (pull full out).
5. Ignition Switch -- OFF.
6. Master Switch -- OFF.
7. Control Lock -- INSTALL.
8. Fuel Selector Valve -- RIGHT.



AMPLIFIED PROCEDURES

STARTING ENGINE

Proper fuel management and throttle adjustments are the determining factors in securing an easy start from your continuous-flow fuel-injection engine. The procedure outlined in this section should be followed closely as it is effective under nearly all operating conditions.

Conventional full rich mixture and high RPM propeller settings are used for starting; the throttle, however, should be fully closed initially. When ready to start, place the auxiliary fuel pump switch in the HIGH position and advance the throttle to obtain 8-10 gal/hr fuel flow. Then close the throttle and turn off the auxiliary fuel pump. Place the ignition switch in the START position. While cranking, slowly advance the throttle until the engine starts. Slow throttle advancement is essential since the engine will start readily when the correct fuel/air ratio is obtained. When the engine has started, reset the throttle to the desired idle speed (800-1000 RPM).

The continuous-flow fuel injection system will inject atomized fuel in the intake ports as soon as the throttle and mixture controls are opened and the auxiliary fuel pump is turned on. If the auxiliary pump is turned on accidentally while the engine is stopped, with the throttle open and the mixture rich, solid fuel will collect temporarily in the cylinder intake ports, the quantity depending on the amount of the throttle opening and the length of time the pump has been operating. If this happens, it is advisable to wait a few minutes until this fuel drains away before starting the engine. To avoid flooding, turn the auxiliary fuel pump switch off promptly when the fuel flow reaches 10 gal/hr during preparation for engine start.

Engine mis-starts characterized by weak, intermittent firing followed by puffs of black smoke from the exhaust are caused by overpriming or flooding. This situation is more apt to develop in hot weather, or when the engine is hot. If it occurs, repeat the starting routine with the throttle approximately 1/2 open, the mixture in idle cut-off and the auxiliary fuel pump switch off. As the engine fires, move the mixture control to full rich and decrease the throttle to idle.

Engine mis-starts characterized by sufficient power to take the engine away from the starter but dying in 3 to 5 revolutions are the result of an excessively lean mixture after the start and can occur in warm or cold temperatures. Repeat the starting procedure but allow additional priming time with the auxiliary fuel pump switch on HIGH before cranking is started. If extremely hot temperatures have caused vapor which prevents a

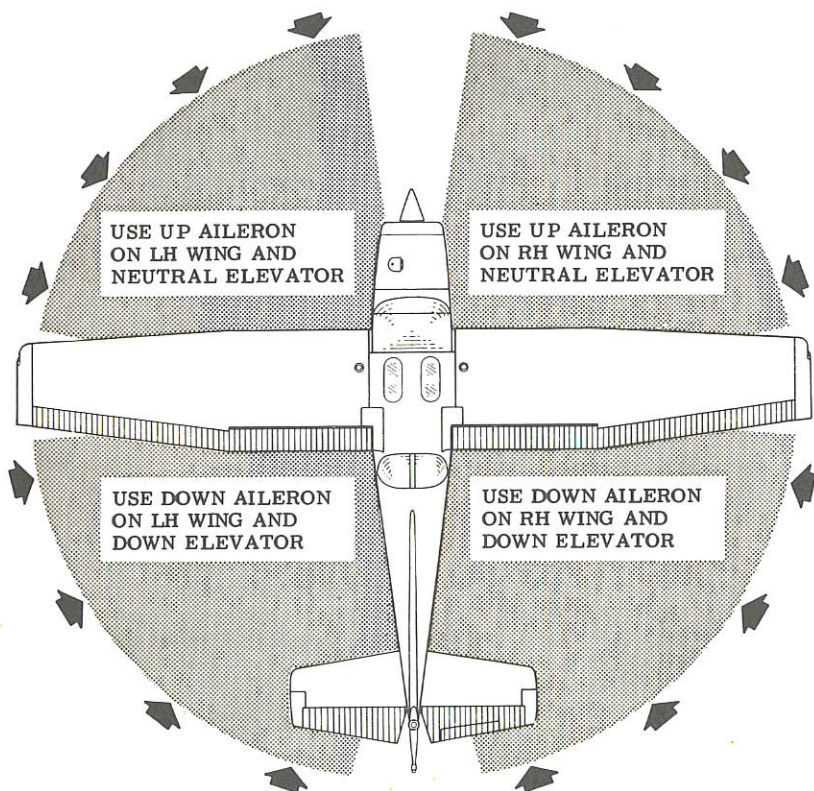

CODE

WIND DIRECTION



NOTE

Strong quartering tail winds require caution. Avoid sudden bursts of the throttle and sharp braking when the airplane is in this attitude. Use the steerable nose wheel and rudder to maintain direction.

Figure 4-2. Taxiing Diagram

start, it will be necessary to hold the auxiliary fuel pump switch in the HIGH position for 5 to 10 seconds or more to flush the vapor through the fuel lines until the fuel flow reaches 10 gal/hr. Then turn off the pump and proceed with normal starting procedures.

If prolonged cranking is necessary, allow the starter motor to cool at frequent intervals, since excessive heat may damage the armature.

After starting, if the oil pressure gage does not begin to show pressure within 30 seconds in normal temperatures and 60 seconds in very cold weather, shut off the engine and investigate. Lack of oil pressure can cause serious engine damage.

NOTE

Additional details concerning cold weather starting and operation may be found under Cold Weather Operation paragraphs in this section.

TAXIING

When taxiing, it is important that speed and use of brakes be held to a minimum and that all controls be utilized (see Taxiing Diagram, figure 4-2) to maintain directional control and balance. Taxiing over loose gravel or cinders should be done at low engine speed to avoid abrasion and stone damage to the propeller tips.

BEFORE TAKEOFF

WARM-UP

Since the engine is closely cowled for efficient in-flight cooling, precautions should be taken to avoid overheating on the ground. Full throttle checks on the ground are not recommended unless the pilot has good reason to suspect that the engine is not turning up properly.

MAGNETO CHECK

The magneto check should be made at 1800 RPM as follows. Move ignition switch first to R position and note RPM. Next move switch back to BOTH to clear the other set of plugs. Then move switch to L position, note RPM and return the switch to the BOTH position. RPM drop should not exceed 150 RPM on either magneto or show greater than 50 RPM differen-

tial between magnetos. If there is a doubt concerning operation of the ignition system, RPM checks at higher engine speeds will usually confirm whether a deficiency exists.

An absence of RPM drop may be an indication of faulty grounding of one side of the ignition system or should be cause for suspicion that the magneto timing is set in advance of the setting specified.

ALTERNATOR CHECK

Prior to flight where verification of proper alternator and alternator control unit operation is essential (such as night or instrument flights), a positive verification can be made by loading the electrical system momentarily (3 to 5 seconds) with the landing light, during the engine runup (1800 RPM). The ammeter will remain within a needle width of the initial reading if the alternator and alternator control unit are operating properly.

TAKEOFF

POWER CHECK

It is important to check full-throttle engine operation early in the takeoff run. Any sign of rough engine operation or sluggish engine acceleration is good cause for discontinuing the takeoff.

Full throttle runups over loose gravel are especially harmful to propeller tips. When takeoffs must be made over a gravel surface, it is very important that the throttle be advanced slowly. This allows the airplane to start rolling before takeoff RPM is developed, and the gravel will be blown back of the propeller rather than pulled into it. When unavoidable small dents appear in the propeller blades, they should be corrected immediately as described in Section 8 under Propeller Care.

For maximum engine power, the mixture should be adjusted during the initial takeoff roll to the fuel flow corresponding to the field elevation. (Refer to the fuel flow placard located adjacent to the fuel flow indicator). The power increase is significant above 3000 feet and this procedure should always be employed for field elevations greater than 5000 feet above sea level.

After full throttle is applied, adjust the throttle friction lock clockwise to prevent the throttle from creeping back from a maximum power position. Similar friction lock adjustment should be made as required in other flight conditions to maintain a fixed throttle setting.

WING FLAP SETTINGS

Normal takeoffs are accomplished with wing flaps 0°- 10°. Using 10° wing flaps reduces the ground run and total distance over an obstacle by approximately 5 percent.

If 10° wing flaps are used for takeoff, they should be left down until all obstacles are cleared and a safe flap retraction speed of 70 KIAS is reached. To clear an obstacle with wing flaps 10°, an obstacle clearance speed of 58 KIAS should be used.

Soft field takeoffs can be performed with 15° flaps by lifting the airplane off the ground as soon as practical in a slightly tail-low attitude. If no obstacles are ahead, the airplane should be leveled off immediately to accelerate to a safer climb speed. When departing a soft field with an aft C.G. loading, the elevator trim should be adjusted towards the nose down direction to give comfortable control wheel forces during the initial climb. Flap deflections greater than 15° are not approved for takeoff.

With wing flaps retracted and no obstructions ahead, a takeoff climb-out speed of 75-85 KIAS would be most efficient.

CROSSWIND TAKEOFF

Takeoffs into strong crosswinds normally are performed with the minimum flap setting necessary for the field length, to minimize the drift angle immediately after takeoff. With the ailerons partially deflected into the wind, the airplane is accelerated to a speed slightly higher than normal, then pulled off abruptly to prevent possible settling back to the runway while drifting. When clear of the ground, make a coordinated turn into the wind to correct for drift.

ENROUTE CLIMB

Normal climbs are performed at 85-95 KIAS with flaps up and maximum power for the best combination of engine cooling, rate of climb and forward visibility. The mixture should be leaned in accordance with the fuel flow placard.

If it is necessary to climb rapidly to clear mountains or reach favorable winds or better weather at high altitudes, the best rate-of-climb speed should be used. This speed is 78 KIAS at sea level, decreasing to 73 KIAS at 10,000 feet. Maximum power should be used and the mixture should be leaned according to the fuel flow placard.

If an obstruction ahead requires a steep climb angle, a best angle-of-

climb speed should be used with flaps up and maximum power. This speed is 57 KIAS at sea level, increasing to 63 KIAS at 10,000 feet.

CRUISE

Normal cruising is performed between 60% and 80% power. The engine RPM and corresponding fuel consumption for various altitudes can be determined by using your Cessna Power Computer or the data in Section 5.

NOTE

Cruising should be done at 80% power until a total of 50 hours has accumulated or oil consumption has stabilized. This is to ensure proper seating of the rings and is applicable to new engines, and engines in service following cylinder replacement or top overhaul of one or more cylinders.

The Cruise Performance Table, figure 4-3, illustrates the advantage of higher altitude on both true airspeed and nautical miles per gallon. In addition, the beneficial effect of lower cruise power on nautical miles per gallon at a given altitude can be observed. This table should be used as a guide, along with the available winds aloft information, to determine the most favorable altitude and power setting for a given trip. The selection of cruise altitude on the basis of the most favorable wind conditions and the use of low power settings are significant factors that should be considered on every trip to reduce fuel consumption.

For reduced noise levels, it is desirable to select the lowest RPM in the

ALTITUDE	80% POWER		70% POWER		60% POWER	
	KTAS	NMPG	KTAS	NMPG	KTAS	NMPG
3000 Feet	126	11.2	119	12.0	110	12.9
6000 Feet	130	11.5	122	12.3	112	13.1
9000 Feet	---	---	125	12.6	114	13.3
Standard Conditions					Zero Wind	

Figure 4-3. Cruise Performance Table

green arc range for a given percent power that will provide smooth engine operation. The cowl flap should be opened, if necessary, to maintain the cylinder head temperature at approximately two-thirds of the normal operating range (green arc).

For best fuel economy at 70% power or less, the engine may be operated at one gallon per hour leaner than shown in this handbook and on the power computer. This will result in approximately 8% greater range than shown in this handbook accompanied by approximately a 4 knot decrease in speed.

The fuel injection system employed on this engine is considered to be non-icing. In the event that unusual conditions cause the intake air filter to become clogged or iced over, an alternate intake air valve opens automatically for the most efficient use of either normal or alternate air depending on the amount of filter blockage.

LEANING WITH A CESSNA ECONOMY MIXTURE INDICATOR (EGT)

Exhaust gas temperature (EGT) as shown on the optional Cessna Economy Mixture Indicator may be used as an aid for mixture leaning in cruising flight at 80% power or less. To adjust the mixture, using this indicator, lean to establish the peak EGT as a reference point and then enrichen the mixture by a desired increment based on figure 4-4.

Continuous operation at peak EGT is authorized only at 70° power or less. This best economy mixture setting results in approximately 8% greater range than shown in this handbook accompanied by approximately a 4 knot decrease in speed.

NOTE

Operation on the lean side of peak EGT is not approved.

MIXTURE DESCRIPTION	EXHAUST GAS TEMPERATURE
RECOMMENDED LEAN (Pilot's Operating Handbook and Power Computer)	50°F Rich of Peak EGT
BEST ECONOMY (70% Power or Less)	Peak EGT

Figure 4-4. EGT Table

When leaning the mixture, if a distinct peak is not obtained, use the corresponding maximum EGT as a reference point for enriching the mixture to the desired cruise setting. Any change in altitude or power will require a recheck of the EGT indication.

STALLS

The stall characteristics are conventional and aural warning is provided by a stall warning horn which sounds between 5 and 10 knots above the stall in all configurations.

Power off stall speeds at maximum weight for both forward and aft C.G. are presented in Section 5.

SPINS

Intentional spins are approved in this airplane within certain restricted loadings. Spins with baggage loadings or occupied rear seat(s) are not approved.

However, before attempting to perform spins several items should be carefully considered to assure a safe flight. No spins should be attempted without first having received dual instruction both in spin entries and spin recoveries from a qualified instructor who is familiar with the spin characteristics of the Cessna R172K.

The cabin should be clean and all loose equipment (including the microphone and rear seat belts) should be stowed or secured. For a solo flight in which spins will be conducted, the copilot's seat belt and shoulder harness should also be secured. The seat belts and shoulder harnesses should be adjusted to provide proper restraint during all anticipated flight conditions. However, care should be taken to ensure that the pilot can easily reach the flight controls and produce maximum control travels.

It is recommended that, where feasible, entries be accomplished at high enough altitude that recoveries are completed 4000 feet or more above ground level. At least 1000 feet of altitude loss should be allowed for a 1-turn spin and recovery, while a 6-turn spin and recovery may require somewhat more than twice that amount. For example, the recommended entry altitude for a 6-turn spin would be 6000 feet above ground level. In any case, entries should be planned so that recoveries are completed **well above** the minimum 1500 feet above ground level required by FAR 91.71. Another reason for using high altitudes for practicing spins is that a greater field of view is provided which will assist in maintaining pilot orientation.

The normal entry is made from a power-off stall. As the stall is approached, the elevator control should be smoothly pulled to the full aft position. Just prior to reaching the stall "break", rudder control in the desired direction of the spin rotation should be applied so that full rudder deflection is reached almost simultaneously with reaching full aft elevator. A slightly greater rate of deceleration than for normal stall entries, application of ailerons in the direction of the desired spin, and the use of power at the entry will assure more consistent and positive entries to the spin. As the airplane begins to spin, reduce the power to idle and return the ailerons to neutral. Both elevator and rudder controls should be held full with the spin until the spin recovery is initiated. An inadvertent relaxation of either of these controls could result in the development of a nose-down spiral.

For the purpose of training in spins and spin recoveries, a 1 or 2-turn spin is adequate and should be used. Up to 2 turns, the spin will progress to a fairly rapid rate of rotation and a steep attitude. Application of recovery controls will produce prompt recoveries (within 1/4 turn). During extended spins of two to three turns or more, the spin will tend to change into a spiral, particularly to the right. This will be accompanied by an increase in airspeed and gravity loads on the airplane. If this occurs, recovery should be accomplished quickly by leveling the wings and recovering from the resulting dive.

Regardless of how many turns the spin is held or how it is entered, the following recovery technique should be used:

1. VERIFY THAT THROTTLE IS IN IDLE POSITION ANDAILERONS ARE NEUTRAL.
2. APPLY AND **HOLD** FULL RUDDER OPPOSITE TO THE DIRECTION OF ROTATION.
3. JUST **AFTER** THE RUDDER REACHES THE STOP, MOVE THE CONTROL WHEEL **BRISKLY** FORWARD FAR ENOUGH TO BREAK THE STALL.
4. **HOLD** THESE CONTROL INPUTS UNTIL ROTATION STOPS.
5. AS ROTATION STOPS, NEUTRALIZE RUDDER, AND MAKE A SMOOTH RECOVERY FROM THE RESULTING DIVE.

NOTE

If disorientation precludes a visual determination of the direction of rotation, the symbolic airplane in the turn coordinator may be referred to for this information.

Variation in basic airplane rigging or in weight and balance due to installed equipment or right seat occupancy can cause differences in behavior, particularly in extended spins. These differences are normal and

will result in variations in the spin characteristics and in the spiraling tendencies for spins of more than 2 turns. However, the aforementioned recovery technique should always be used and will result in the most expeditious recovery from any spin.

Intentional spins with flaps extended are prohibited, since the high speeds which may occur during recovery are potentially damaging to the flap/wing structure.

LANDING

NORMAL LANDING

Normal landing approaches can be made with power-on or power-off at speeds of 65-75 KIAS with flaps up, and 60-70 KIAS with flaps down. Surface winds and air turbulence are usually the primary factors in determining the most comfortable approach speeds. Steep slips should be avoided with flap settings greater than 20° due to a slight tendency for the elevator to oscillate under certain combinations of airspeed, sideslip angle, and center of gravity loadings.

Actual touchdown should be made with power-off and on the main wheels first to reduce the landing speed and subsequent need for braking in the landing roll. The nose wheel is lowered to the runway gently after the speed has diminished to avoid unnecessary nose gear loads. This procedure is especially important in rough or soft field landings.

SHORT FIELD LANDING

For a short field landing in smooth air conditions, make an approach at 60 KIAS with full flaps using enough power to control the glide path. (Slightly higher approach speeds should be used under turbulent air conditions.) After all approach obstacles are cleared, progressively reduce power and maintain the approach speed by lowering the nose of the airplane. Touchdown should be made with power-off and on the main wheels first. Immediately after touchdown, lower the nose wheel and apply heavy braking as required. For maximum brake effectiveness, retract the flaps, hold the control wheel full back, and apply maximum brake pressure without sliding the tires.

CROSSWIND LANDING

When landing in a strong crosswind, use the minimum flap setting required for the field length. If flap settings greater than 20° are used in sideslips with full rudder deflection, some elevator oscillation may be felt

at normal approach speeds. However, this does not affect control of the airplane. Although the crab or combination method of drift correction may be used, the wing-low method gives the best control. After touchdown, hold a straight course with the steerable nose wheel and occasional braking if necessary.

BALKED LANDING

In a balked landing (go-around) climb, reduce the wing flap setting to 20° immediately after full power is applied and maintain 55 KIAS until immediate obstacles are cleared. Then slowly retract the wing flaps after accelerating to an airspeed of 65 KIAS. If obstacles must be cleared during the go-around climb, leave the wing flaps in the 10° to 20° range and maintain 55 KIAS until the obstacles are cleared. Lean the mixture according to the fuel flow placard. After clearing any obstacles, the flaps may be retracted as the airplane accelerates to the normal flaps-up climb speed of 85-95 KIAS.

COLD WEATHER OPERATION

STARTING

Prior to starting on a cold morning, it is advisable to pull the propeller through several times by hand to "break loose" or "limber" the oil, thus conserving battery energy.

NOTE

When pulling the propeller through by hand, treat it as if the ignition switch is turned on. A loose or broken ground wire on either magneto could cause the engine to fire.

Starting can be expedited by switching the auxiliary fuel pump to HIGH position and advancing the throttle for a fuel flow of 8-10 gal./hr. for 3 to 6 seconds.

In extremely cold (-18°C and lower) weather, the use of an external preheater and an external power source are recommended whenever possible to obtain positive starting and to reduce wear and abuse to the engine and electrical system. Pre-heat will thaw the oil trapped in the oil cooler, which probably will be congealed prior to starting in extremely cold temperatures. When using an external power source, the position of the master switch is important. Refer to Section 9, Supplements, for Ground Service Plug Receptacle operating details.

For quick, smooth engine starts in very cold temperatures, use six strokes of the manual primer before cranking, with an additional one or two strokes as the engine starts.

WARM-UP

In very cold weather, no oil temperature indication need be apparent before takeoff. After a suitable warm-up period (2 to 5 minutes at 1000 RPM), with cylinder head temperatures at bottom of green arc, the engine is ready for takeoff if it accelerates smoothly and the oil pressure is normal and steady.

INFLIGHT

During let-down, observe engine temperatures closely and carry sufficient power to maintain them in the recommended operating range.

HOT WEATHER OPERATION

Refer to the general warm temperature starting information under Starting Engine in this section. Avoid prolonged engine operation on the ground.

NOISE ABATEMENT

Increased emphasis on improving the quality of our environment requires renewed effort on the part of all pilots to minimize the effect of airplane noise on the public.

We, as pilots, can demonstrate our concern for environmental improvement, by application of the following suggested procedures, and thereby tend to build public support for aviation:

1. Pilots operating aircraft under VFR over outdoor assemblies of persons, recreational and park areas, and other noise-sensitive areas should make every effort to fly not less than 2000 feet above the surface, weather permitting, even though flight at a lower level may be consistent with the provisions of government regulations.
2. During departure from or approach to an airport, climb after takeoff and descent for landing should be made so as to avoid prolonged flight at low altitude near noise-sensitive areas.

NOTE

The above recommended procedures do not apply where

they would conflict with Air Traffic Control clearances or instructions, or where, in the pilot's judgment, an altitude of less than 2000 feet is necessary for him to adequately exercise his duty to see and avoid other aircraft.

The certificated noise level for the Model R172K at 2550 pounds maximum weight is 74.1 dB(A). No determination has been made by the Federal Aviation Administration that the noise levels of this airplane are or should be acceptable or unacceptable for operation at, into, or out of, any airport.

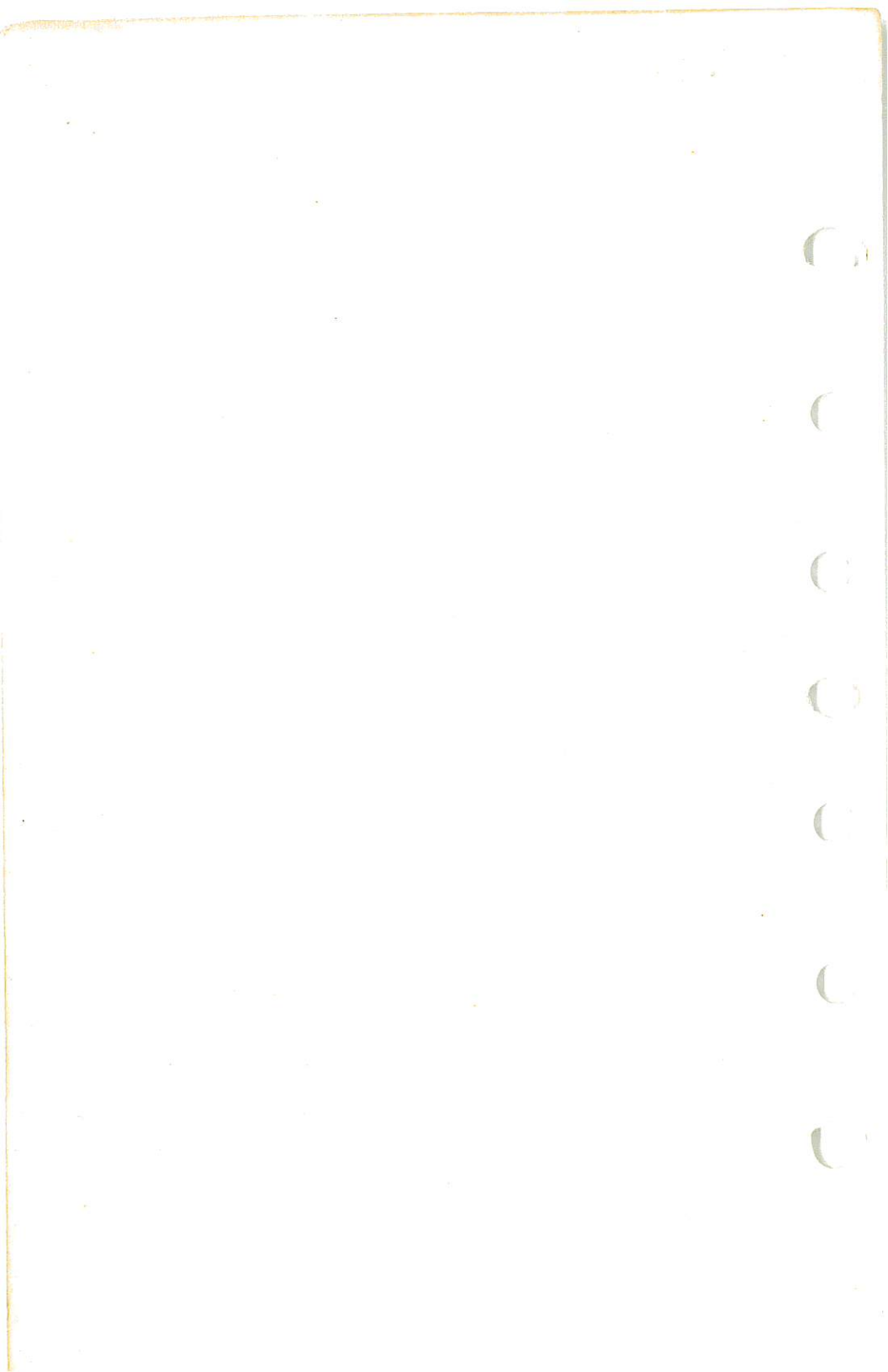

SECTION 5 PERFORMANCE

TABLE OF CONTENTS

	Page
Introduction	5-3
Use Of Performance Charts	5-3
Sample Problem	5-3
Takeoff	5-4
Cruise	5-5
Fuel Required	5-5
Landing	5-7
Demonstrated Operating Temperature	5-7
Figure 5-1, Airspeed Calibration - Normal Static Source	5-8
Airspeed Calibration - Alternate Static Source	5-9
Figure 5-2, Temperature Conversion Chart	5-10
Figure 5-3, Stall Speeds	5-11
Figure 5-4, Takeoff Distance - 2550 Lbs	5-12
Takeoff Distance - 2400 Lbs And 2200 Lbs	5-13
Figure 5-5, Maximum Rate Of Climb	5-14
Figure 5-6, Time, Fuel, And Distance To Climb - Maximum Rate Of Climb	5-15
Time, Fuel, And Distance To Climb - Normal Climb	5-16
Figure 5-7, Cruise Performance - 2000 Feet	5-17
Cruise Performance - 4000 Feet	5-18
Cruise Performance - 6000 Feet	5-19
Cruise Performance - 8000 Feet	5-20
Cruise Performance - 10,000 Feet	5-21
Cruise Performance - 12,000 Feet	5-22
Figure 5-8, Range Profile - 49 Gallons Fuel	5-23
Range Profile - 66 Gallons Fuel	5-24
Figure 5-9, Endurance Profile - 49 Gallons Fuel	5-25
Endurance Profile - 66 Gallons Fuel	5-26
Figure 5-10, Landing Distance	5-27



INTRODUCTION

Performance data charts on the following pages are presented so that you may know what to expect from the airplane under various conditions, and also, to facilitate the planning of flights in detail and with reasonable accuracy. The data in the charts has been computed from actual flight tests with the airplane and engine in good condition and using average piloting techniques.

It should be noted that the performance information presented in the range and endurance profile charts allows for 45 minutes reserve fuel at the specified cruise power. Fuel flow data for cruise is based on the recommended lean mixture setting. Some indeterminate variables such as mixture leaning technique, fuel metering characteristics, engine and propeller condition, and air turbulence may account for variations of 10% or more in range and endurance. Therefore, it is important to utilize all available information to estimate the fuel required for the particular flight.

USE OF PERFORMANCE CHARTS

Performance data is presented in tabular or graphical form to illustrate the effect of different variables. Sufficiently detailed information is provided in the tables so that conservative values can be selected and used to determine the particular performance figure with reasonable accuracy.

SAMPLE PROBLEM

The following sample flight problem utilizes information from the various charts to determine the predicted performance data for a typical flight. The following information is known:

AIRPLANE CONFIGURATION

Takeoff weight	2500 Pounds
Usable fuel	49 Gallons

TAKEOFF CONDITIONS

Field pressure altitude	1500 Feet
Temperature	28°C (16°C above standard)
Wind component along runway	12 Knot Headwind
Field length	3500 Feet

SECTION 5
PERFORMANCE

CESSNA
MODEL R172K

CRUISE CONDITIONS

Total distance	365 Nautical Miles
Pressure altitude	5500 Feet
Temperature	20°C (16°C above standard)
Expected wind enroute	10 Knot Headwind

LANDING CONDITIONS

Field pressure altitude	2000 Feet
Temperature	25°C
Field length	3000 Feet

TAKEOFF

The takeoff distance chart, figure 5-4, should be consulted, keeping in mind that the distances shown are based on the short field technique. Conservative distances can be established by reading the chart at the next higher value of weight, altitude and temperature. For example, in this particular sample problem, the takeoff distance information presented for a weight of 2550 pounds, pressure altitude of 2000 feet and a temperature of 30°C should be used and results in the following:

Ground roll	1070 Feet
Total distance to clear a 50-foot obstacle	1820 Feet

These distances are well within the available takeoff field length. However, a correction for the effect of wind may be made based on Note 2 of the takeoff chart. The correction for a 12 knot headwind is:

$$\frac{12 \text{ Knots}}{9 \text{ Knots}} \times 10\% = 13\% \text{ Decrease}$$

This results in the following distances, corrected for wind:

Ground roll, zero wind	1070
Decrease in ground roll (1070 feet × 13%)	<u>139</u>
Corrected ground roll	931 Feet
Total distance to clear a 50-foot obstacle, zero wind	1820
Decrease in total distance (1820 feet × 13%)	<u>237</u>
Corrected total distance to clear a 50-foot obstacle	1583 Feet

CRUISE

The cruising altitude should be selected based on a consideration of trip length, winds aloft, and the airplane's performance. A cruising altitude and the expected wind enroute have been given for this sample problem. However, the power setting selection for cruise must be determined based on several considerations. These include the cruise performance characteristics presented in figure 5-7, the range profile chart presented in figure 5-8, and the endurance profile chart presented in figure 5-9.

The relationship between power and range is illustrated by the range profile chart. Considerable fuel savings and longer range result when lower power settings are used. For this sample problem, a cruise power of approximately 70% will be used.

The cruise performance chart for 6000 feet pressure altitude is entered using 20°C above standard temperature. These values most nearly correspond to the planned altitude and expected temperature conditions. The power setting chosen is 2500 RPM and 22 inches of manifold pressure, which results in the following:

Power	70%
True airspeed	124 Knots
Cruise fuel flow	9.9 GPH

The power computer may be used to determine power and fuel consumption more accurately during the flight.

FUEL REQUIRED

The total fuel requirement for the flight may be estimated using the performance information in figures 5-6 and 5-7. For this sample problem, figure 5-6 shows that a normal climb from 2000 feet to 6000 feet requires 1.5 gallons of fuel. The corresponding distance during the climb is 10 nautical miles. These values are for a standard temperature and are sufficiently accurate for most flight planning purposes. However, a further correction for the effect of temperature may be made as noted on the climb chart. The approximate effect of a non-standard temperature is to increase the time, fuel, and distance by 10% for each 10°C above standard temperature, due to the lower rate of climb. In this case, assuming a temperature 16°C above standard, the correction would be:

$$\frac{16^{\circ}\text{C}}{10^{\circ}\text{C}} \times 10\% = 16\% \text{ Increase}$$

SECTION 5
PERFORMANCE

CESSNA
MODEL R172K

With this factor included, the fuel estimate would be calculated as follows:

Fuel to climb, standard temperature	1.5
Increase due to non-standard temperature (1.5 × 16%)	<u>0.2</u>
Corrected fuel to climb	1.7 Gallons

Using a similar procedure for the distance during climb results in 12 nautical miles.

The resultant cruise distance is:

Total distance	365
Climb distance	<u>-12</u>
Cruise distance	353 Nautical Miles

With an expected 10 knot headwind, the ground speed for cruise is predicted to be:

124
<u>-10</u>
114 Knots

Therefore, the time required for the cruise portion of the trip is:

$$\frac{353 \text{ Nautical Miles}}{114 \text{ Knots}} = 3.1 \text{ Hours}$$

The fuel required for cruise is:

$$3.1 \text{ hours} \times 9.9 \text{ gallons/hour} = 30.7 \text{ Gallons}$$

The total estimated fuel required is as follows:

Engine start, taxi, and takeoff	1.4
Climb	1.7
Cruise	<u>30.7</u>
Total fuel required	33.8 Gallons

Once the flight is underway, ground speed checks will provide a more accurate basis for estimating the time enroute and the corresponding fuel

required to complete the trip with ample reserve.

LANDING

A procedure similar to takeoff should be used for estimating the landing distance at the destination airport. Figure 5-10 presents landing distance information for the short field technique. The distances corresponding to 2000 feet pressure altitude and a temperature of 30°C are as follows:

Ground roll	700 Feet
Total distance to clear a 50-foot obstacle	1390 Feet

A correction for the effect of wind may be made, based on Note 2 of the landing chart using the same procedure as outlined for takeoff.

DEMONSTRATED OPERATING TEMPERATURE

Satisfactory engine cooling has been demonstrated for this airplane with an outside air temperature 23°C above standard. This is not to be considered as an operating limitation. Reference should be made to Section 2 for engine operating limitations.

AIRSPEED CALIBRATION

NORMAL STATIC SOURCE

FLAPS UP	
KIAS	50 60 70 80 90 100 110 120 130 140 150 160
KCAS	54 62 71 80 89 98 107 117 127 137 147 157
FLAPS 10°	
KIAS	40 50 60 70 80 90 100 110 --- --- --- ---
KCAS	49 55 63 72 81 90 99 108 --- --- --- ---
FLAPS 40°	
KIAS	40 50 60 70 80 85 --- --- --- --- --- ---
KCAS	48 55 63 72 81 86 --- --- --- --- --- ---

Figure 5-1. Airspeed Calibration (Sheet 1 of 2)

AIRSPEED CALIBRATION

ALTERNATE STATIC SOURCE

HEATER/VENTS AND WINDOWS CLOSED

FLAPS UP													
NORMAL KIAS	50	60	70	80	90	100	110	120	130	140	150	160	
ALTERNATE KIAS	43	57	69	79	90	100	109	119	128	137	147	156	
FLAPS 10°													
NORMAL KIAS	40	50	60	70	80	90	100	110	-----				
ALTERNATE KIAS	32	43	56	68	78	89	98	108	-----				
FLAPS 40°													
NORMAL KIAS	40	50	60	70	80	85	-----						
ALTERNATE KIAS	31	42	54	64	75	81	-----						

HEATER/VENTS OPEN AND WINDOWS CLOSED

FLAPS UP													
NORMAL KIAS	50	60	70	80	90	100	110	120	130	140	150	160	
ALTERNATE KIAS	42	56	67	77	87	96	106	115	125	134	144	153	
FLAPS 10°													
NORMAL KIAS	40	50	60	70	80	90	100	110	-----				
ALTERNATE KIAS	30	41	55	66	76	85	95	105	-----				
FLAPS 40°													
NORMAL KIAS	40	50	60	70	80	85	-----						
ALTERNATE KIAS	25	37	49	61	72	76	-----						

Figure 5-1. Airspeed Calibration (Sheet 2 of 2)

TEMPERATURE CONVERSION CHART

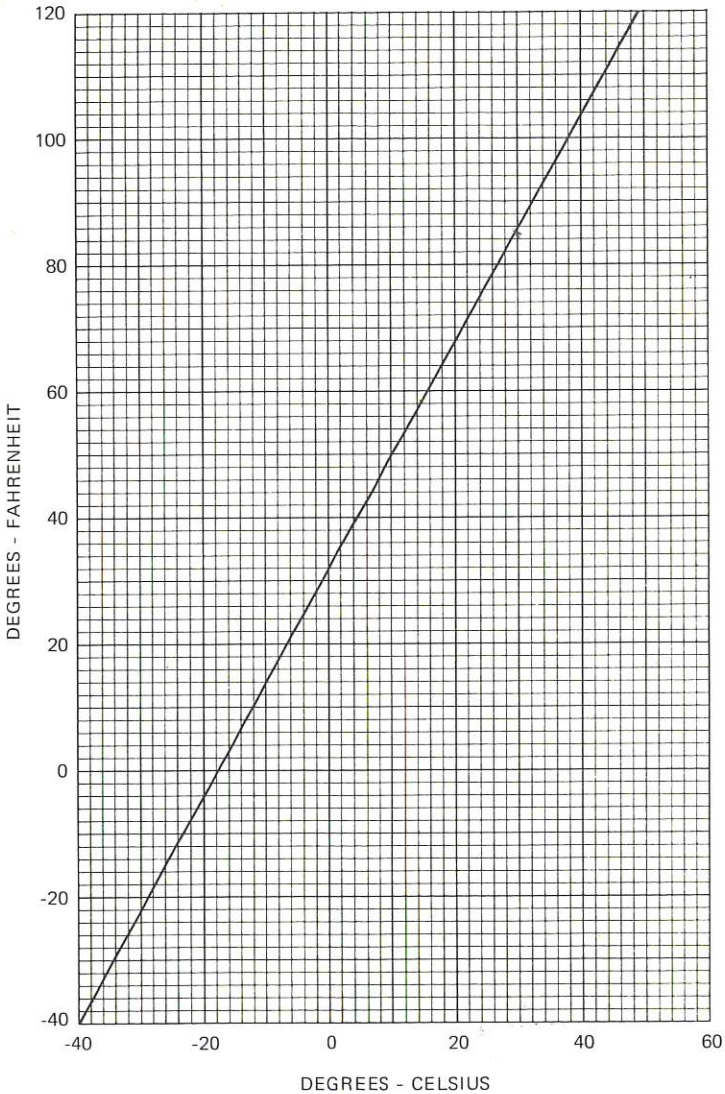

Figure 5-2. Temperature Conversion Chart

STALL SPEEDS

CONDITIONS:
Power Off

NOTES:

1. Maximum altitude loss during a stall recovery may be as much as 160 feet.
2. KIAS values are approximate.

MOST REARWARD CENTER OF GRAVITY

WEIGHT LBS	FLAP DEFLECTION	ANGLE OF BANK							
		0°		30°		45°		60°	
		KIAS	KCAS	KIAS	KCAS	KIAS	KCAS	KIAS	KCAS
2550	UP	45	53	48	57	54	63	64	75
	10°	42	50	45	54	50	59	59	71
	40°	36	46	39	49	43	55	51	65

MOST FORWARD CENTER OF GRAVITY

WEIGHT LBS	FLAP DEFLECTION	ANGLE OF BANK							
		0°		30°		45°		60°	
		KIAS	KCAS	KIAS	KCAS	KIAS	KCAS	KIAS	KCAS
2550	UP	49	56	53	60	58	67	69	79
	10°	43	51	46	55	51	61	61	72
	40°	38	48	41	52	45	57	54	68

Figure 5-3. Stall Speeds

**TAKEOFF DISTANCE
MAXIMUM WEIGHT 2550 LBS**

SHORT FIELD

CONDITIONS:

- Flaps 10°
- 2600 RPM, Full Throttle and Mixture Set at
- Placard Fuel Flow Prior to Brake Release
- Cowl Flap Open
- Paved, Level, Dry Runway
- Zero Wind

MIXTURE SETTING	
PRESS ALT	GPH
S.L.	16
2000	15
4000	14
6000	13
8000	12

NOTES:

1. Short field technique as specified in Section 4.
2. Decrease distances 10% for each 9 knots headwind. For operation with tail winds up to 10 knots, increase distances by 10% for each 2 knots.
3. For operation on a dry, grass runway, increase distances by 15% of the "ground roll" figure.

WEIGHT LBS	TAKEOFF SPEED KIAS		PRESS ALT FT	0°C			10°C			20°C			30°C			40°C			
	LIFT OFF	AT 50 FT		GRND ROLL	TOTAL TO CLEAR 50 FT OBS	GRND ROLL	TOTAL TO CLEAR 50 FT OBS	GRND ROLL	TOTAL TO CLEAR 50 FT OBS	GRND ROLL	TOTAL TO CLEAR 50 FT OBS	GRND ROLL	TOTAL TO CLEAR 50 FT OBS	GRND ROLL	TOTAL TO CLEAR 50 FT OBS	GRND ROLL	TOTAL TO CLEAR 50 FT OBS		
2550	54	58	S.L.	715	1225	770	1315	830	1410	895	1510	960	1625	895	1510	960	1625		
			1000	780	1335	840	1435	905	1540	975	1655	1050	1780	975	1655	1050	1780		
			2000	855	1460	920	1570	995	1690	1070	1820	1150	1960	1150	1960	1150	1960	1150	1960
			3000	935	1600	1010	1725	1090	1860	1175	2005	1265	2165	1265	2165	1265	2165	1265	2165
			4000	1025	1760	1110	1900	1195	2055	1290	2220	1390	2405	1390	2405	1390	2405	1390	2405
			5000	1125	1945	1220	2105	1315	2280	1420	2470	1530	2685	1530	2685	1530	2685	1530	2685
			6000	1240	2155	1340	2340	1450	2540	1565	2765	1690	3015	1690	3015	1690	3015	1690	3015
			7000	1365	2405	1480	2615	1600	2850	1730	3115	1870	3415	1870	3415	1870	3415	1870	3415
			8000	1510	2695	1635	2945	1770	3225	1915	3545	2075	3920	2075	3920	2075	3920	2075	3920

Figure 5-4. Takeoff Distance (Sheet 1 of 2)

**TAKEOFF DISTANCE
2400 LBS AND 2200 LBS**

SHORT FIELD

REFER TO SHEET 1 FOR APPROPRIATE CONDITIONS AND NOTES.

WEIGHT LBS	TAKEOFF SPEED KIAS		PRESS ALT FT	0°C			10°C			20°C			30°C			40°C		
	LIFT OFF	AT 50 FT		GRND ROLL	TO CLEAR 50 FT OBS	TOTAL TO CLEAR 50 FT OBS	GRND ROLL	TO CLEAR 50 FT OBS	TOTAL TO CLEAR 50 FT OBS	GRND ROLL	TO CLEAR 50 FT OBS	TOTAL TO CLEAR 50 FT OBS	GRND ROLL	TO CLEAR 50 FT OBS	TOTAL TO CLEAR 50 FT OBS	GRND ROLL	TO CLEAR 50 FT OBS	TOTAL TO CLEAR 50 FT OBS
2400	52	56	S.L.	620	1070	670	1145	720	1225	775	1315	835	1410	1410	835	1315	1410	
			1000	680	1165	730	1250	790	1340	845	1435	910	1540	1540	910	1435	1540	
			2000	740	1270	800	1365	860	1465	925	1575	995	1690	1690	995	1575	1690	
			3000	810	1390	875	1495	945	1605	1015	1730	1095	1860	1860	1095	1730	1860	
	54	56	4000	890	1520	960	1640	1035	1765	1115	1905	1200	2055	2055	1200	1905	2055	
			5000	975	1675	1055	1805	1135	1950	1225	2110	1320	2280	2280	1320	2110	2280	
			6000	1070	1850	1160	2000	1250	2165	1350	2345	1455	2540	2540	1455	2345	2540	
			7000	1180	2050	1275	2220	1380	2410	1490	2620	1610	2850	2850	1610	2620	2850	
2200	50	54	8000	1305	2280	1410	2480	1525	2700	1650	2950	1780	3225	3225	1780	2950	3225	
			S.L.	510	880	550	940	590	1005	635	1075	680	1150	1150	680	1075	1150	
			1000	555	955	600	1025	645	1095	690	1175	740	1255	1255	740	1175	1255	
			2000	605	1040	655	1115	705	1195	755	1280	810	1370	1370	810	1280	1370	
	54	54	3000	660	1135	715	1215	770	1305	825	1400	890	1500	1500	890	1400	1500	
			4000	725	1240	780	1330	840	1430	905	1535	975	1650	1650	975	1535	1650	
			5000	795	1355	855	1460	925	1570	1005	1690	1070	1820	1820	1070	1690	1820	
			6000	870	1490	940	1605	1015	1730	1095	1865	1175	2010	2010	1175	1865	2010	
54	54	7000	955	1645	1035	1770	1115	1915	1205	2065	1295	2235	2235	1295	2065	2235		
		8000	1055	1815	1140	1965	1230	2125	1330	2300	1430	2495	2495	1430	2300	2495		

Figure 5-4. Takeoff Distance (Sheet 2 of 2)

MAXIMUM RATE OF CLIMB

CONDITIONS:

Flaps Up
2600 RPM
Full Throttle
Mixture Set at Placard Fuel Flow
Cowl Flap Open

MIXTURE SETTING	
PRESS ALT	GPH
S.L.	16
4000	14
8000	12
12,000	10

WEIGHT LBS	PRESS ALT FT	CLIMB SPEED KIAS	RATE OF CLIMB - FPM			
			-20°C	0°C	20°C	40°C
2550	S.L.	78	1040	945	845	750
	2000	77	925	830	740	650
	4000	76	810	720	635	545
	6000	75	695	615	530	445
	8000	74	585	505	425	345
	10,000	73	480	400	320	---
	12,000	72	370	295	220	---

Figure 5-5. Maximum Rate of Climb

TIME, FUEL, AND DISTANCE TO CLIMB

MAXIMUM RATE OF CLIMB

CONDITIONS:

Flaps Up
2600 RPM
Full Throttle
Mixture Set at Placard Fuel Flow
Cowl Flap Open
Standard Temperature

MIXTURE SETTING	
PRESS ALT	GPH
S.L.	16
4000	14
8000	12
12,000	10

NOTES:

1. Add 1.4 gallons of fuel for engine start, taxi and takeoff allowance.
2. Increase time, fuel and distance by 10% for each 10°C above standard temperature.
3. Distances shown are based on zero wind.

WEIGHT LBS	PRESSURE ALTITUDE FT	TEMP °C	CLIMB SPEED KIAS	RATE OF CLIMB FPM	FROM SEA LEVEL		
					TIME MIN	FUEL USED GALLONS	DISTANCE NM
2550	S.L.	15	78	870	0	0	0
	1000	13	78	825	1	0.3	2
	2000	11	77	780	2	0.6	3
	3000	9	77	735	4	1.0	5
	4000	7	76	690	5	1.3	7
	5000	5	76	645	7	1.6	9
	6000	3	75	600	8	2.0	11
	7000	1	75	555	10	2.4	14
	8000	-1	74	510	12	2.7	16
	9000	-3	74	465	14	3.2	19
	10,000	-5	73	420	16	3.6	23
	11,000	-7	73	375	19	4.0	26
12,000	-9	72	330	22	4.5	31	

Figure 5-6. Time, Fuel, and Distance to Climb (Sheet 1 of 2)

TIME, FUEL, AND DISTANCE TO CLIMB

NORMAL CLIMB - 90 KIAS

CONDITIONS:

Flaps Up
2600 RPM
Full Throttle
Mixture Set at Placard Fuel Flow
Cowl Flap Open
Standard Temperature

MIXTURE SETTING	
PRESS ALT	GPH
S.L.	16
4000	14
8000	12

NOTES:

1. Add 1.4 gallons of fuel for engine start, taxi and takeoff allowance.
2. Increase time, fuel and distance by 10% for each 10°C above standard temperature.
3. Distances shown are based on zero wind.

WEIGHT LBS	PRESSURE ALTITUDE FT	TEMP °C	RATE OF CLIMB FPM	FROM SEA LEVEL		
				TIME MIN	FUEL USED GALLONS	DISTANCE NM
2550	S.L.	15	845	0	0	0
	1000	13	790	1	0.3	2
	2000	11	740	3	0.7	4
	3000	9	685	4	1.0	6
	4000	7	630	6	1.4	8
	5000	5	575	7	1.8	11
	6000	3	525	9	2.2	14
	7000	1	470	11	2.6	18
	8000	-1	415	13	3.1	21

Figure 5-6. Time, Fuel, and Distance to Climb (Sheet 2 of 2)

CRUISE PERFORMANCE

PRESSURE ALTITUDE 2000 FEET

CONDITIONS:
2550 Pounds
Recommended Lean Mixture
Cowl Flap Closed

NOTE

For best fuel economy at 70% power or less, operate at 1 GPH leaner than shown in this chart or at peak EGT if an EGT indicator is installed.

		20°C BELOW STANDARD TEMP -9°C			STANDARD TEMPERATURE 11°C			20°C ABOVE STANDARD TEMP 31°C		
RPM	MP	% BHP	KTAS	GPH	% BHP	KTAS	GPH	% BHP	KTAS	GPH
2600	24	---	---	---	81	126	11.4	78	127	11.0
	23	78	122	11.1	76	122	10.7	73	123	10.3
	22	73	118	10.3	71	119	10.0	68	119	9.6
	21	68	114	9.6	65	114	9.3	63	114	9.0
2500	25	---	---	---	81	126	11.5	79	127	11.1
	24	80	122	11.2	77	123	10.8	74	124	10.5
	23	75	119	10.6	72	120	10.2	70	120	9.9
	22	70	116	9.9	67	116	9.5	65	116	9.2
2400	25	79	122	11.2	76	123	10.8	74	123	10.4
	24	74	119	10.5	72	120	10.2	69	120	9.8
	23	70	116	9.9	67	116	9.5	65	116	9.2
	22	65	112	9.2	63	112	8.9	61	112	8.6
2300	25	74	119	10.5	72	119	10.1	69	120	9.8
	24	70	116	9.9	67	116	9.5	65	116	9.2
	23	65	112	9.2	63	112	8.9	61	112	8.7
	22	61	108	8.6	59	108	8.4	57	107	8.1
2200	25	69	115	9.8	67	115	9.4	64	115	9.1
	24	65	112	9.2	63	112	8.9	61	111	8.6
	23	61	108	8.6	59	108	8.3	57	107	8.1
	22	57	104	8.1	55	103	7.8	53	102	7.6
	21	52	99	7.6	51	98	7.3	49	97	7.1
	20	48	94	7.0	47	93	6.8	45	91	6.6
	19	44	88	6.5	43	87	6.3	41	86	6.2

Figure 5-7. Cruise Performance (Sheet 1 of 6)

CRUISE PERFORMANCE

PRESSURE ALTITUDE 4000 FEET

CONDITIONS:
2550 Pounds
Recommended Lean Mixture
Cowl Flap Closed

NOTE

For best fuel economy at 70% power or less, operate at 1 GPH leaner than shown in this chart or at peak EGT if an EGT indicator is installed.

		20°C BELOW STANDARD TEMP -13°C			STANDARD TEMPERATURE 7°C			20°C ABOVE STANDARD TEMP 27°C		
RPM	MP	% BHP	KTAS	GPH	% BHP	KTAS	GPH	% BHP	KTAS	GPH
2600	23	81	126	11.5	79	127	11.1	76	127	10.7
	22	76	122	10.8	73	123	10.4	71	123	10.0
	21	71	119	10.0	68	119	9.7	66	119	9.3
	20	66	114	9.3	63	114	9.0	61	113	8.7
2500	24	82	126	11.6	79	127	11.2	77	128	10.8
	23	77	123	11.0	75	124	10.6	72	124	10.2
	22	73	120	10.3	70	120	9.9	68	120	9.6
	21	68	116	9.6	65	116	9.3	63	116	9.0
2400	24	77	123	10.9	74	124	10.5	72	124	10.2
	23	72	120	10.2	70	120	9.9	68	120	9.5
	22	68	116	9.6	65	116	9.2	63	116	9.0
	21	63	112	8.9	61	111	8.6	59	110	8.4
2300	24	72	120	10.2	70	120	9.9	67	120	9.5
	23	68	116	9.6	65	116	9.3	63	116	9.0
	22	63	112	9.0	61	112	8.7	59	111	8.4
	21	59	108	8.4	57	107	8.1	55	106	7.9
2200	24	68	116	9.6	65	116	9.2	63	115	8.9
	23	63	112	9.0	61	112	8.7	59	111	8.4
	22	59	108	8.4	57	107	8.1	55	106	7.9
	21	55	103	7.9	53	102	7.6	51	101	7.4
	20	51	98	7.3	49	97	7.1	47	95	6.9
	19	46	92	6.8	45	91	6.6	43	89	6.4

Figure 5-7. Cruise Performance (Sheet 2 of 6)

CRUISE PERFORMANCE

PRESSURE ALTITUDE 6000 FEET

CONDITIONS:
2550 Pounds
Recommended Lean Mixture
Cowl Flap Closed

NOTE

For best fuel economy at 70% power or less, operate at 1 GPH leaner than shown in this chart or at peak EGT if an EGT indicator is installed.

		20°C BELOW STANDARD TEMP -17°C			STANDARD TEMPERATURE 3°C			20°C ABOVE STANDARD TEMP 23°C		
RPM	MP	% BHP	KTAS	GPH	% BHP	KTAS	GPH	% BHP	KTAS	GPH
2600	23	---	---	---	81	131	11.5	79	131	11.1
	22	79	126	11.2	76	127	10.8	74	127	10.4
	21	74	123	10.5	71	123	10.1	69	123	9.7
	20	69	119	9.7	66	118	9.3	64	118	9.1
2500	23	80	127	11.3	77	128	10.9	75	128	10.6
	22	76	124	10.7	73	124	10.3	70	124	9.9
	21	71	120	10.0	68	120	9.6	66	120	9.3
	20	66	116	9.3	63	116	9.0	61	115	8.7
2400	23	75	124	10.6	72	124	10.2	70	124	9.9
	22	70	120	9.9	68	120	9.6	65	120	9.3
	21	65	116	9.3	63	115	9.0	61	114	8.7
	20	61	111	8.6	59	110	8.4	57	109	8.1
2300	23	71	120	10.0	68	120	9.6	66	120	9.3
	22	66	116	9.3	64	116	9.0	61	115	8.7
	21	61	112	8.7	59	111	8.4	57	110	8.2
	20	57	107	8.1	55	105	7.9	53	105	7.6
2200	23	66	116	9.3	63	116	9.0	61	115	8.7
	22	62	112	8.7	59	111	8.4	57	110	8.2
	21	57	107	8.2	55	106	7.9	53	105	7.7
	20	53	102	7.6	51	101	7.4	49	99	7.2
	19	49	96	7.1	47	95	6.8	45	93	6.7
	18	44	90	6.6	43	89	6.4	41	87	6.2

Figure 5-7. Cruise Performance (Sheet 3 of 6)

CRUISE PERFORMANCE

PRESSURE ALTITUDE 8000 FEET

CONDITIONS:
2550 Pounds
Recommended Lean Mixture
Cowl Flap Closed

NOTE

For best fuel economy at 70% power or less, operate at 1 GPH leaner than shown in this chart or at peak EGT if an EGT indicator is installed.

		20°C BELOW STANDARD TEMP -21°C			STANDARD TEMPERATURE -1°C			20°C ABOVE STANDARD TEMP 19°C		
RPM	MP	% BHP	KTAS	GPH	% BHP	KTAS	GPH	% BHP	KTAS	GPH
2600	21	77	127	10.9	74	128	10.5	72	127	10.1
	20	72	123	10.1	69	123	9.8	67	122	9.4
	19	66	118	9.4	64	118	9.0	62	116	8.8
	18	61	113	8.6	59	111	8.3	57	110	8.1
2500	21	74	125	10.4	71	125	10.0	69	124	9.7
	20	69	120	9.7	66	120	9.4	64	119	9.1
	19	64	116	9.0	61	115	8.7	59	113	8.4
	18	59	110	8.4	56	109	8.1	54	108	7.8
2400	21	68	120	9.6	65	119	9.3	63	118	9.0
	20	63	115	9.0	61	114	8.6	59	113	8.4
	19	58	110	8.3	56	108	8.0	54	107	7.8
	18	54	104	7.7	52	103	7.5	50	101	7.2
2300	21	64	116	9.1	62	115	8.7	59	114	8.5
	20	59	111	8.5	57	109	8.2	55	109	7.9
	19	55	105	7.9	53	104	7.6	51	103	7.4
	18	50	100	7.3	48	98	7.0	47	96	6.8
2200	21	60	111	8.5	57	110	8.2	55	109	7.9
	20	55	106	7.9	53	105	7.7	51	103	7.4
	19	51	100	7.4	49	99	7.1	47	97	6.9
	18	47	94	6.8	45	93	6.6	43	91	6.4

Figure 5-7. Cruise Performance (Sheet 4 of 6)

CRUISE PERFORMANCE

PRESSURE ALTITUDE 10,000 FEET

CONDITIONS:
2550 Pounds
Recommended Lean Mixture
Cowl Flap Closed

NOTE

For best fuel economy at 70% power or less, operate at 1 GPH leaner than shown in this chart or at peak EGT if an EGT indicator is installed.

		20°C BELOW STANDARD TEMP -25°C			STANDARD TEMPERATURE -5°C			20°C ABOVE STANDARD TEMP 15°C		
RPM	MP	% BHP	KTAS	GPH	% BHP	KTAS	GPH	% BHP	KTAS	GPH
2600	19	69	123	9.8	67	122	9.4	64	121	9.1
	18	64	117	9.0	61	116	8.7	59	115	8.4
	17	58	110	8.3	56	109	8.0	54	108	7.8
	16	53	104	7.6	51	102	7.3	49	100	7.1
2500	19	67	120	9.4	64	119	9.1	62	118	8.8
	18	62	115	8.7	59	113	8.4	57	112	8.2
	17	56	108	8.0	54	107	7.8	52	105	7.5
	16	50	101	7.3	49	99	7.1	47	97	6.8
2400	19	61	114	8.6	59	112	8.3	56	111	8.1
	18	56	108	8.0	54	107	7.8	52	105	7.5
	17	51	102	7.4	49	100	7.2	48	99	7.0
	16	47	95	6.8	45	94	6.6	43	91	6.4
2300	19	57	109	8.2	55	108	7.9	53	107	7.7
	18	53	104	7.6	51	102	7.3	49	100	7.1
	17	48	97	7.0	46	95	6.8	45	94	6.6
2200	19	53	104	7.7	51	103	7.4	49	101	7.2
	18	49	98	7.1	47	97	6.9	45	95	6.7
	17	45	92	6.6	43	90	6.4	42	88	6.2

Figure 5-7. Cruise Performance (Sheet 5 of 6)

CRUISE PERFORMANCE

PRESSURE ALTITUDE 12,000 FEET

CONDITIONS:
2550 Pounds
Recommended Lean Mixture
Cowl Flap Closed

NOTE

For best fuel economy at 70% power or less, operate at 1 GPH leaner than shown in this chart or at peak EGT if an EGT indicator is installed.

		20°C BELOW STANDARD TEMP -29°C			STANDARD TEMPERATURE -9°C			20°C ABOVE STANDARD TEMP 11°C		
RPM	MP	% BHP	KTAS	GPH	% BHP	KTAS	GPH	% BHP	KTAS	GPH
2600	18	67	122	9.4	64	121	9.1	62	120	8.8
	17	61	115	8.7	59	114	8.4	57	113	8.1
	16	55	108	7.9	53	107	7.7	51	105	7.4
	15	50	100	7.2	48	99	7.0	46	97	6.7
2500	18	64	119	9.1	62	118	8.8	60	117	8.5
	17	59	112	8.4	57	112	8.1	55	110	7.8
	16	53	106	7.7	51	104	7.4	49	102	7.2
	15	47	97	6.9	45	95	6.7	44	93	6.5
2400	18	58	112	8.3	56	111	8.0	54	109	7.8
	17	54	106	7.7	52	104	7.5	50	103	7.2
	16	49	100	7.1	47	98	6.9	46	96	6.7
	15	44	93	6.6	43	90	6.4	41	88	6.2
2300	18	55	108	7.9	53	106	7.6	51	104	7.4
	17	50	101	7.3	48	100	7.1	47	98	6.8
	16	46	95	6.7	44	93	6.5	43	90	6.3
2200	18	51	103	7.4	49	101	7.1	47	99	6.9
	17	47	96	6.8	45	94	6.6	44	92	6.4

Figure 5-7. Cruise Performance (Sheet 6 of 6)

RANGE PROFILE

45 MINUTES RESERVE 49 GALLONS USABLE FUEL

CONDITIONS:
2550 Pounds
Recommended Lean Mixture for Cruise
Standard Temperature
Zero Wind

NOTE:
This chart allows for the fuel used for engine start, taxi, takeoff and climb, and the distance during a normal climb up to 8,000 feet and maximum climb above 8,000 feet.

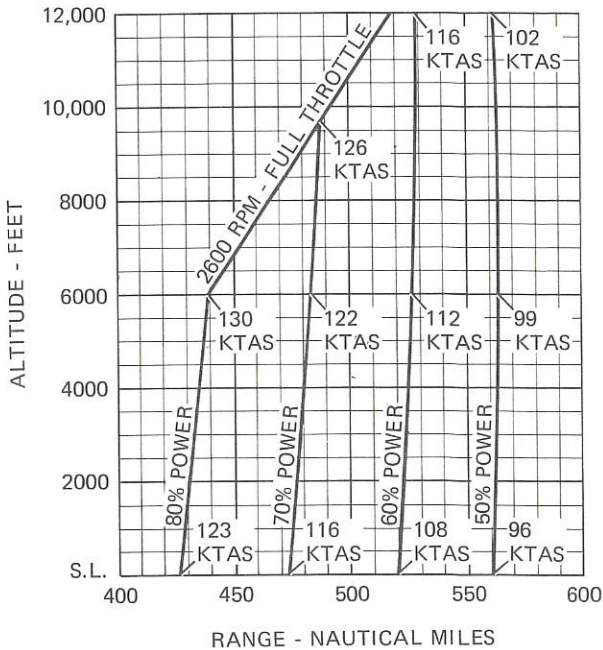

Figure 5-8. Range Profile (Sheet 1 of 2)

RANGE PROFILE
45 MINUTES RESERVE
66 GALLONS USABLE FUEL

CONDITIONS:

2550 Pounds
Recommended Lean Mixture for Cruise
Standard Temperature
Zero Wind

NOTE:

This chart allows for the fuel used for engine start, taxi, takeoff and climb, and the distance during a normal climb up to 8,000 feet and maximum climb above 8,000 feet.

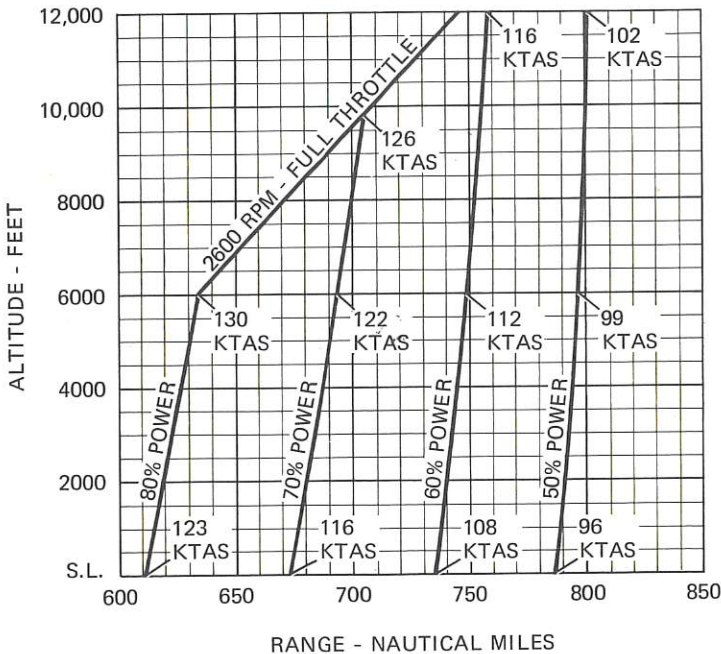

Figure 5-8. Range Profile (Sheet 2 of 2)

ENDURANCE PROFILE

45 MINUTES RESERVE
49 GALLONS USABLE FUEL

CONDITIONS:
2550 Pounds
Recommended Lean Mixture for Cruise
Standard Temperature

NOTE:
This chart allows for the fuel used for engine start, taxi, takeoff and climb, and the time during a normal climb up to 8,000 feet and maximum climb above 8,000 feet.

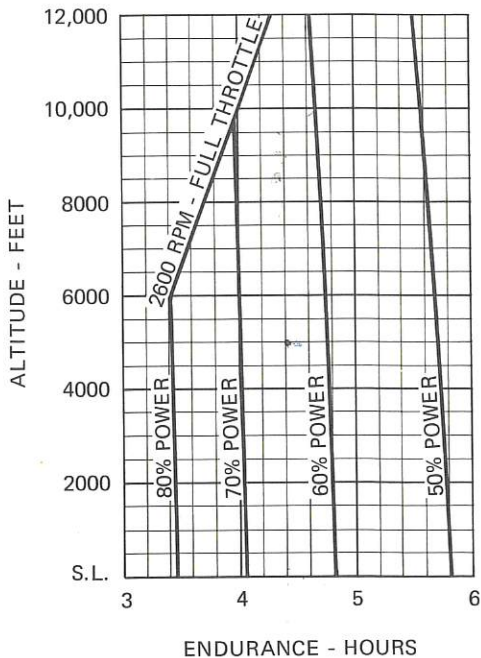

Figure 5-9. Endurance Profile (Sheet 1 of 2)

ENDURANCE PROFILE

45 MINUTES RESERVE
66 GALLONS USABLE FUEL

CONDITIONS:

2550 Pounds
Recommended Lean Mixture for Cruise
Standard Temperature

NOTE:

This chart allows for the fuel used for engine start, taxi, takeoff and climb, and the time during a normal climb up to 8,000 feet and maximum climb above 8,000 feet.

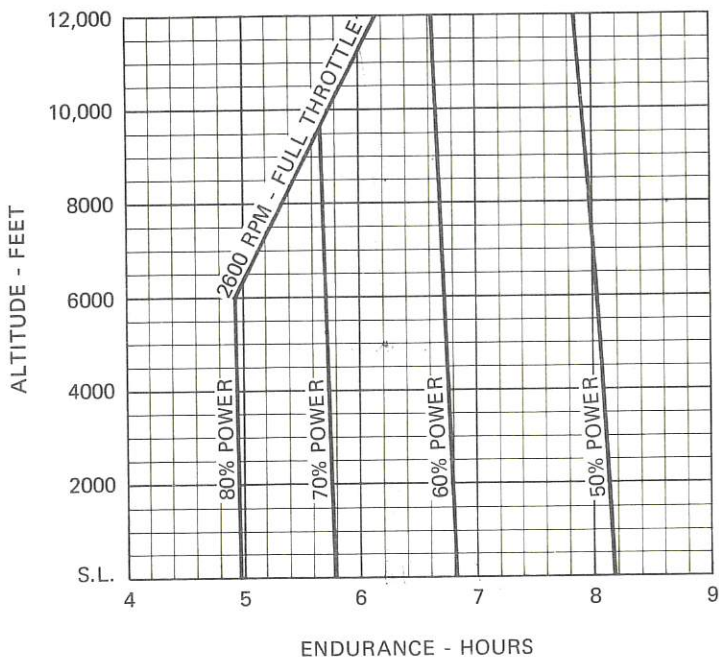

Figure 5-9. Endurance Profile (Sheet 2 of 2)

LANDING DISTANCE

SHORT FIELD

CONDITIONS:

- Flaps 40°
- Power Off
- Maximum Braking
- Paved, Level, Dry Runway
- Zero Wind

NOTES:

1. Short field technique as specified in Section 4.
2. Decrease distances 10% for each 9 knots headwind. For operation with tailwinds up to 10 knots, increase distances by 10% for each 2 knots.
3. For operation on a dry, grass runway, increase distances by 40% of the "ground roll" figure.

WEIGHT LBS	SPEED AT 50 FT KIAS	PRESS ALT FT	0°			10°			20°			30°			40°			
			GRND ROLL	TOTAL TO CLEAR 50 FT OBS	GRND ROLL	TOTAL TO CLEAR 50 FT OBS	GRND ROLL	TOTAL TO CLEAR 50 FT OBS	GRND ROLL	TOTAL TO CLEAR 50 FT OBS	GRND ROLL	TOTAL TO CLEAR 50 FT OBS	GRND ROLL	TOTAL TO CLEAR 50 FT OBS				
2550	60	S.L.	590	1225	610	1255	630	1285	655	1320	675	1350	700	1390	725	1425	750	1465
		1000	610	1255	630	1285	655	1320	680	1360	705	1390	730	1430	755	1470	780	1505
		2000	630	1285	655	1320	680	1360	705	1395	730	1435	755	1475	785	1515	810	1550
		3000	655	1320	680	1360	705	1395	730	1435	760	1475	785	1515	815	1560	840	1595
		4000	680	1360	705	1395	730	1435	760	1475	785	1515	815	1560	845	1605	875	1645
		5000	705	1395	730	1435	760	1475	790	1520	815	1560	850	1610	880	1655	905	1690
		6000	735	1440	760	1475	790	1520	820	1565	850	1610	880	1655	905	1690		
		7000	760	1480	790	1520	820	1565	850	1610	880	1655	905	1690				
8000	790	1520	820	1565	850	1610	880	1655	905	1690								

Figure 5-10. Landing Distance

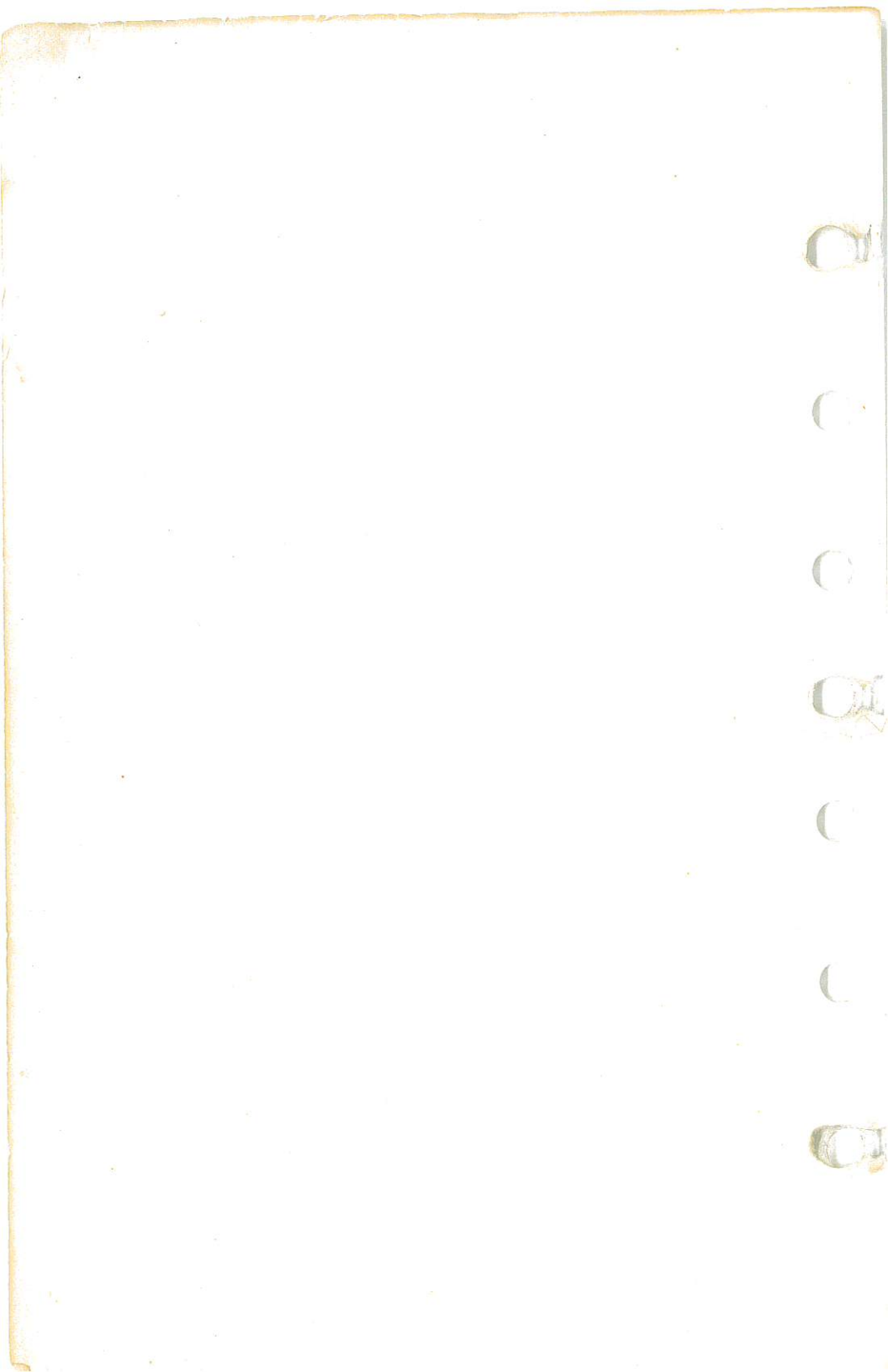

SECTION 6 WEIGHT & BALANCE/ EQUIPMENT LIST

TABLE OF CONTENTS

	Page
Introduction	6-3
Airplane Weighing Procedures	6-3
Weight And Balance	6-6
Equipment List	6-13

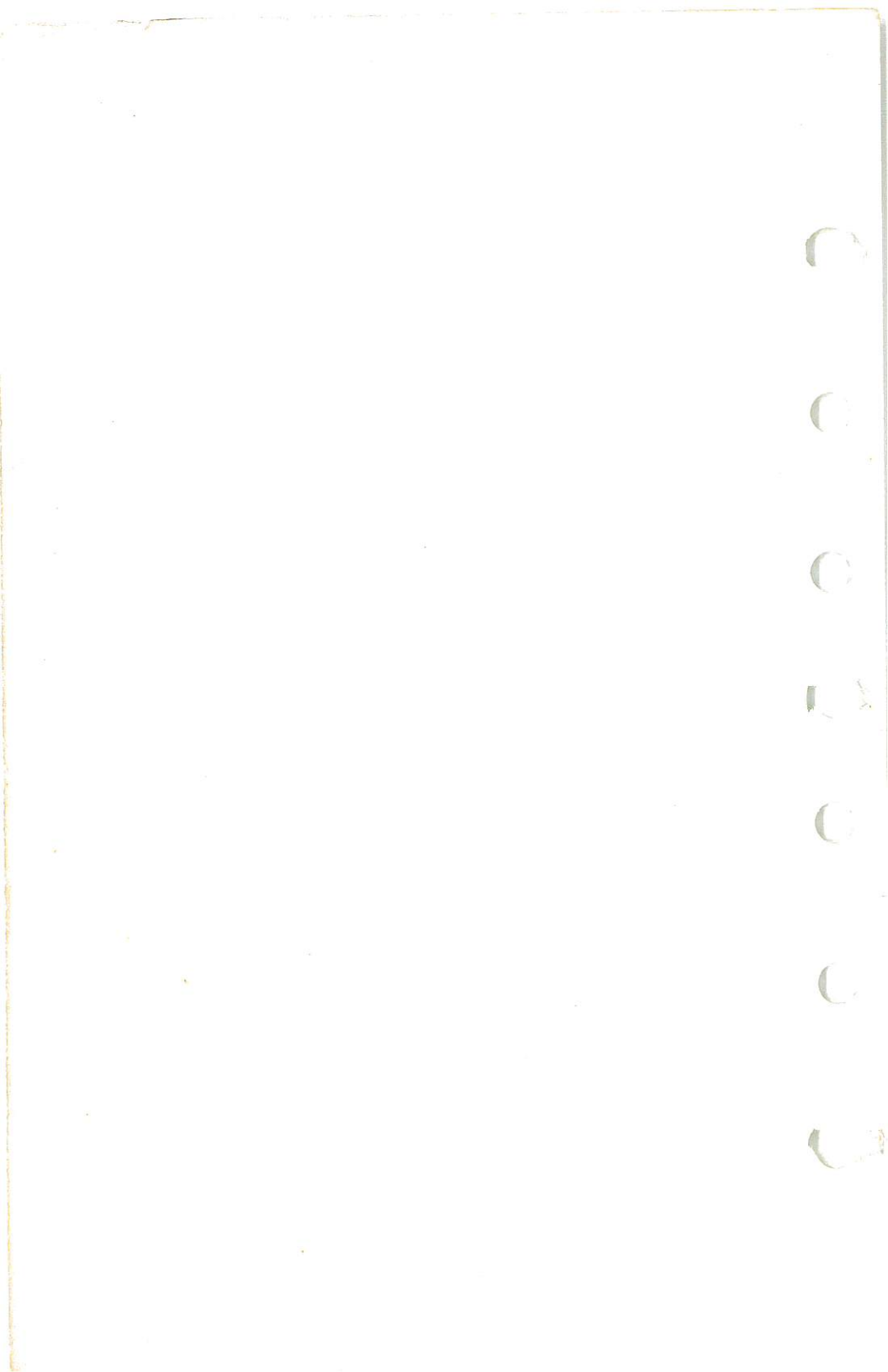

INTRODUCTION

This section describes the procedure for establishing the basic empty weight and moment of the airplane. Sample forms are provided for reference. Procedures for calculating the weight and moment for various operations are also provided. A comprehensive list of all Cessna equipment available for this airplane is included at the back of this section.

It should be noted that specific information regarding the weight, arm, moment and installed equipment list for this airplane can only be found in the appropriate weight and balance records carried in the airplane.

It is the responsibility of the pilot to ensure that the airplane is loaded properly.

AIRPLANE WEIGHING PROCEDURES

1. Preparation:
 - a. Inflate tires to recommended operating pressures.
 - b. Remove the fuel tank sump quick-drain fittings and fuel selector valve drain plug to drain all fuel.
 - c. Remove oil sump drain plug to drain all oil.
 - d. Move sliding seats to the most forward position.
 - e. Raise flaps to the fully retracted position.
 - f. Place all control surfaces in neutral position.
2. Leveling:
 - a. Place scales under each wheel (minimum scale capacity, 500 pounds nose, 1000 pounds each main).
 - b. Deflate the nose tire and/or lower or raise the nose strut to properly center the bubble in the level (see figure 6-1).
3. Weighing:
 - a. With the airplane level and brakes released, record the weight shown on each scale. Deduct the tare, if any, from each reading.
4. Measuring:
 - a. Obtain measurement A by measuring horizontally (along the airplane center line) from a line stretched between the main wheel centers to a plumb bob dropped from the firewall.
 - b. Obtain measurement B by measuring horizontally and parallel to the airplane center line, from center of nose wheel axle, left side, to a plumb bob dropped from the line between the main wheel centers. Repeat on right side and average the measurements.
5. Using weights from item 3 and measurements from item 4, the airplane weight and C.G. can be determined.
6. Basic Empty Weight may be determined by completing figure 6-1.

SECTION 6
WEIGHT & BALANCE/
EQUIPMENT LIST

CESSNA
MODEL R172K

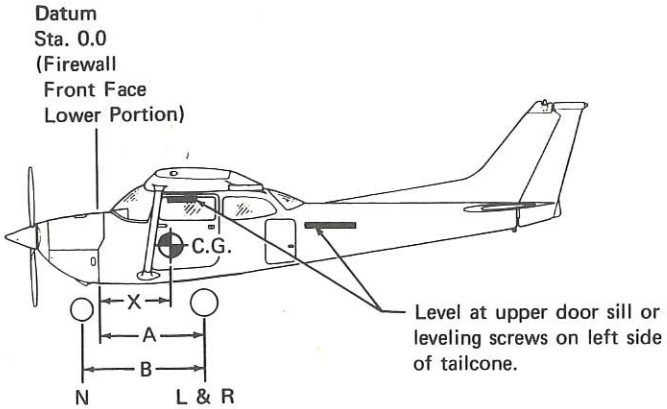

Scale Position	Scale Reading	Tare	Symbol	Net Weight
Left Wheel			L	
Right Wheel			R	
Nose Wheel			N	
Sum of Net Weights (As Weighed)			W	

$$X = \text{ARM} = \frac{(A) - (N) \times (B)}{W}; X = (\quad) - (\quad) \times (\quad) = (\quad) \text{ IN.}$$

Item	Weight (Lbs.)	X C.G. Arm (In.)	Moment/1000 (Lbs.-In.)
Airplane Weight (From Item 5, page 6-3)			
Add : Oil (9 Qts at 7.5 Lbs/Gal)	17	-21.5	-0.4
Add Unusable Fuel:			
Std. Tanks (3 Gal at 6 Lbs/Gal)		46.0	
Long Range Tanks (2 Gal at 6 Lbs/Gal)		45.0	
Equipment Changes			
Airplane Basic Empty Weight			

Figure 6-1. Sample Airplane Weighing

SAMPLE WEIGHT AND BALANCE RECORD

(Continuous History of Changes in Structure or Equipment Affecting Weight and Balance)

AIRPLANE MODEL		SERIAL NUMBER				PAGE NUMBER			
DATE	ITEM NO. In Out	DESCRIPTION OF ARTICLE OR MODIFICATION	WEIGHT CHANGE				RUNNING BASIC EMPTY WEIGHT		
			ADDED (+)		REMOVED (-)		Wt. (lb.)	Moment /1000	
			Wt. (lb.)	Arm (In.)	Moment /1000	Wt. (lb.)	Arm (In.)	Moment /1000	

Figure 6-2. Sample Weight and Balance Record

WEIGHT AND BALANCE

The following information will enable you to operate your Cessna within the prescribed weight and center of gravity limitations. To figure weight and balance, use the Sample Problem, Loading Graph, and Center of Gravity Moment Envelope as follows:

Take the basic empty weight and moment from appropriate weight and balance records carried in your airplane, and enter them in the column titled YOUR AIRPLANE on the Sample Loading Problem.

NOTE

In addition to the basic empty weight and moment noted on these records, the C.G. arm (fuselage station) is also shown, but need not be used on the Sample Loading Problem. The moment which is shown must be divided by 1000 and this value used as the moment/1000 on the loading problem.

Use the Loading Graph to determine the moment/1000 for each additional item to be carried; then list these on the loading problem.

NOTE

Loading Graph information for the pilot, passengers, and baggage is based on seats positioned for average occupants and baggage loaded in the center of the baggage areas as shown on the Loading Arrangements diagram. For loadings which may differ from these, the Sample Loading Problem lists fuselage stations for these items to indicate their forward and aft C.G. range limitations (seat travel and baggage area limitation). Additional moment calculations, based on the actual weight and C.G. arm (fuselage station) of the item being loaded, must be made if the position of the load is different from that shown on the Loading Graph.

Total the weights and moments/1000 and plot these values on the Center of Gravity Moment Envelope to determine whether the point falls within the envelope, and if the loading is acceptable.

LOADING ARRANGEMENTS

*Pilot or passenger center of gravity on adjustable seats positioned for average occupant. Numbers in parentheses indicate forward and aft limits of occupant center of gravity range.

**Arm measured to the center of the areas shown.

- NOTES:
1. The usable fuel C.G. arm for standard and long range tanks is located at station 48.0.
 2. The rear cabin wall (approximate station 108) or aft baggage wall (approximate station 142) can be used as convenient interior reference points for determining the location of baggage area fuselage stations.

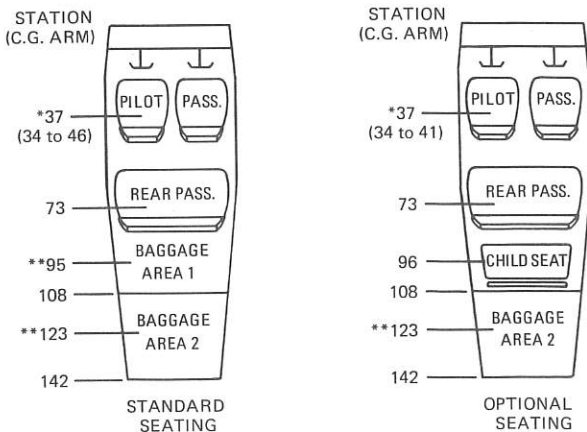
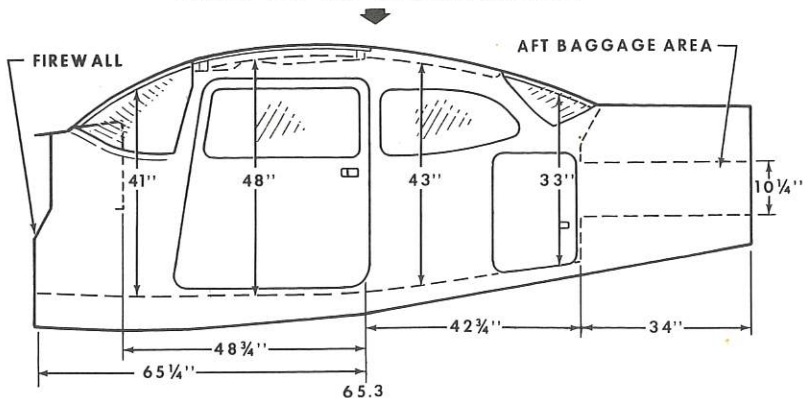

Figure 6-3. Loading Arrangements

CABIN HEIGHT MEASUREMENTS



DOOR OPENING DIMENSIONS

	WIDTH (TOP)	WIDTH (BOTTOM)	HEIGHT (FRONT)	HEIGHT (REAR)
CABIN DOOR	32"	37"	40"	41"
BAGGAGE DOOR	15 1/4"	15 1/4"	22"	21"

— WIDTH —
● LWR WINDOW LINE
* CABIN FLOOR

CABIN WIDTH MEASUREMENTS

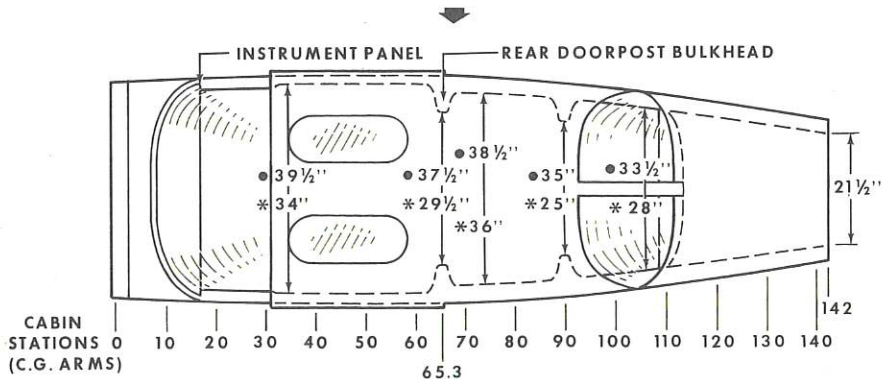

Figure 6-4. Internal Cabin Dimensions

	SAMPLE AIRPLANE		YOUR AIRPLANE	
	Weight (lbs.)	Moment (lb. - ins. /1000)	Weight (lbs.)	Moment (lb. - ins. /1000)
SAMPLE LOADING PROBLEM				
1. Basic Empty Weight (Use the data pertaining to your airplane as it is presently equipped. Includes unusable fuel and full oil)	1592	56.7		
2. Usable Fuel (At 6 Lbs./Gal.) Standard Tanks (49 Gal. Maximum)	294	14.1		
Long Range Tanks (66 Gal. Maximum)				
Reduced Fuel (50 Gal.)				
3. Pilot and Front Passenger (Station 34 to 46)	340	12.6		
4. Rear Passengers	170	12.4		
5. * Baggage Area 1 or Passenger on Child's Seat (Baggage, Station 82 to 108 - 200 Lbs. Max.; Passenger on Child's Seat - 120 Lbs. Max.)	162	15.4		
6. * Baggage Area 2 (Station 108 to 142 - 50 Lbs. Max.)				
7. RAMP WEIGHT AND MOMENT	2558	111.2		
8. Fuel allowance for engine start, taxi, and runup	-8	-4		
9. TAKEOFF WEIGHT AND MOMENT (Subtract Step 8 from Step 7)	2550	110.8		
10. Locate this point (2550 at 110.8) on the Center of Gravity Moment Envelope, and since this point falls within the envelope, the loading is acceptable.				

* The maximum allowable combined weight capacity for baggage areas 1 and 2 is 200 lbs.

Figure 6-5. Sample Loading Problem

APK
36.7
48
37
73
95
123

SECTION 6
WEIGHT & BALANCE/
EQUIPMENT LIST

CESSNA
MODEL R172K

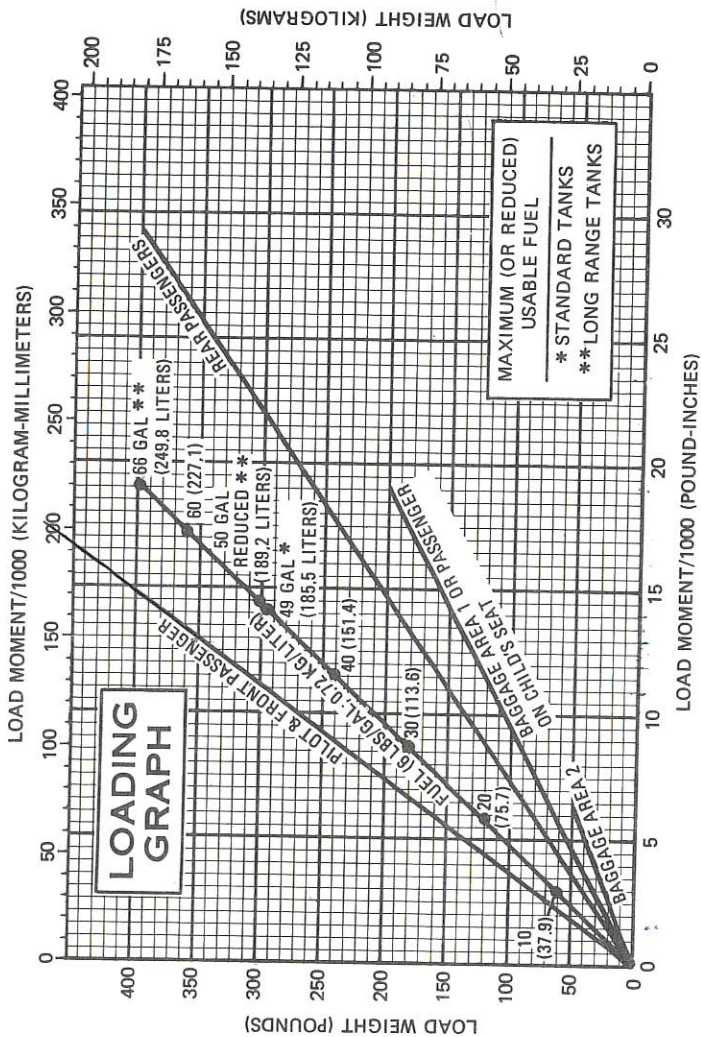

NOTE: Line representing adjustable seats shows the pilot or passenger center of gravity on adjustable seats positioned for an average occupant. Refer to the Loading Arrangements diagram for forward and aft limits of occupant C.G. range.

Figure 6-6. Loading Graph

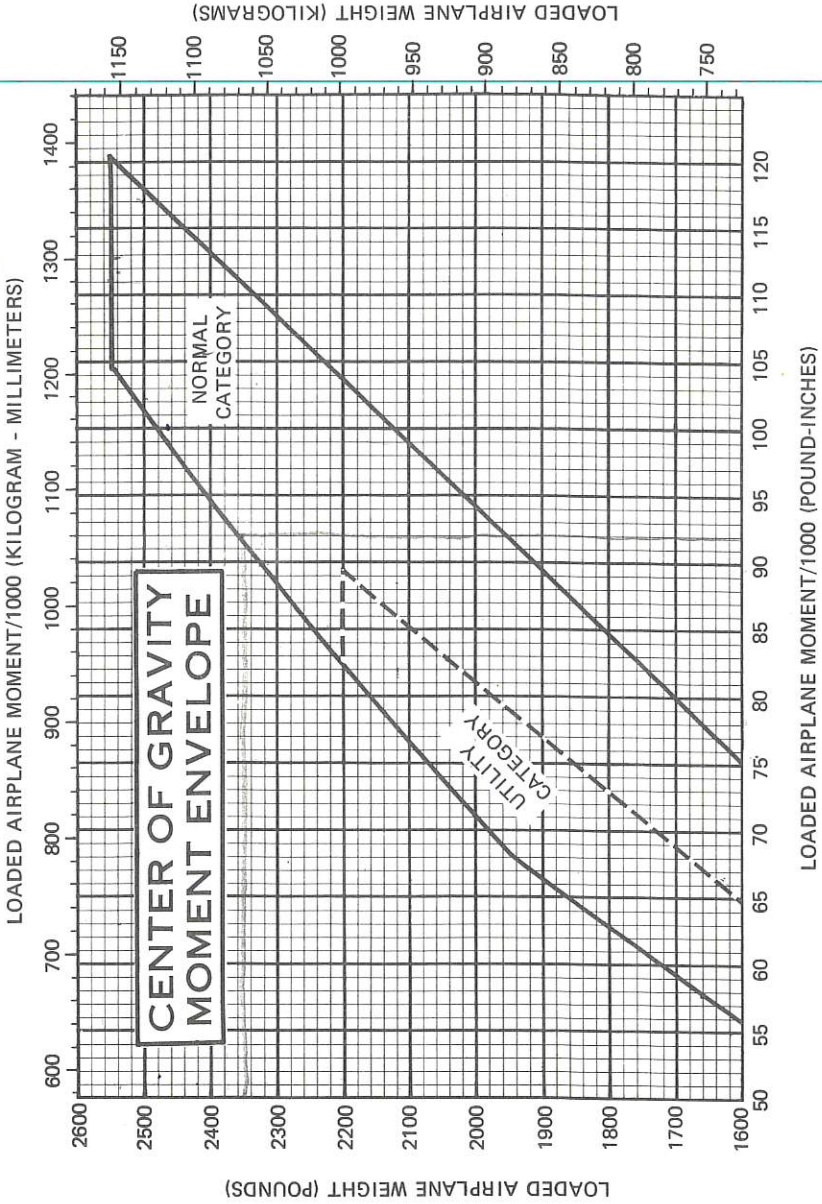

Figure 6-7. Center of Gravity Moment Envelope

SECTION 6
 WEIGHT & BALANCE/
 EQUIPMENT LIST

CESSNA
 MODEL R172K

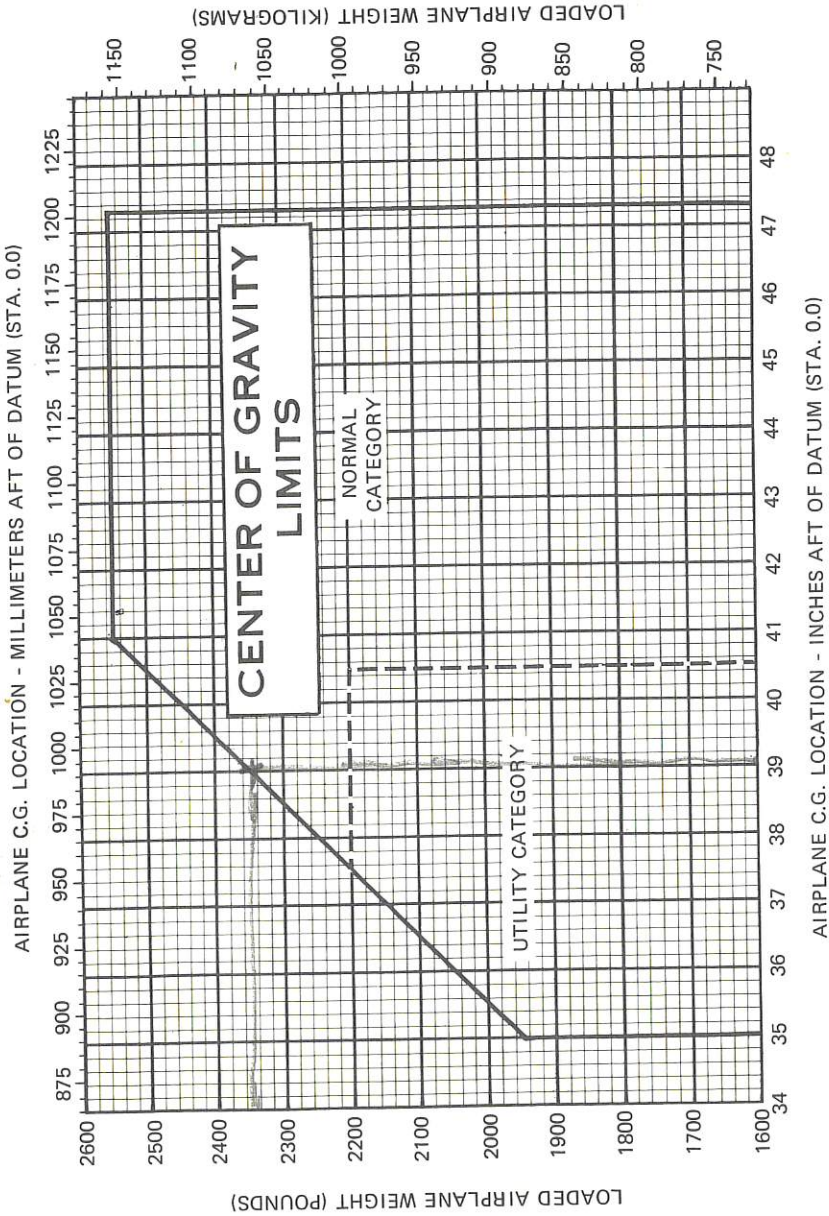

Figure 6-8. Center of Gravity Limits

EQUIPMENT LIST

The following equipment list is a comprehensive list of all Cessna equipment available for this airplane. A separate equipment list of items installed in your specific airplane is provided in your aircraft file. The following list and the specific list for your airplane have a similar order of listing.

This equipment list provides the following information:

An **item number** gives the identification number for the item. Each number is prefixed with a letter which identifies the **descriptive** grouping (example: A. Powerplant & Accessories) under which it is listed. Suffix letters identify the equipment as a required item, a standard item or an optional item. Suffix letters are as follows:

- R = required items of equipment for FAA certification
- S = standard equipment items
- O = optional equipment items replacing required or standard items
- A = optional equipment items which are in addition to required or standard items

A **reference drawing** column provides the drawing number for the item.

NOTE

If additional equipment is to be installed, it must be done in accordance with the reference drawing, accessory kit instructions, or a separate FAA approval.

Columns showing **weight (in pounds)** and **arm (in inches)** provide the weight and center of gravity location for the equipment.

NOTE

Unless otherwise indicated, true values (not net change values) for the weight and arm are shown. Positive arms are distances aft of the airplane datum; negative arms are distances forward of the datum.

NOTE

Asterisks (*) after the item weight and arm indicate complete assembly installations. Some major components of the assembly are listed on the lines immediately following. The summation of these major components does not necessarily equal the complete assembly installation.

SECTION 6
WEIGHT & BALANCE/
EQUIPMENT LIST

CESSNA
MODEL R172K

ITEM NO	EQUIPMENT LIST DESCRIPTION	REF DRAWING	WT LBS	ARM INS
A. POWERPLANT & ACCESSORIES				
A01-R	ENGINE, CONTINENTAL IO-360KB (INCLUDES ELECTRIC STARTER & VACUUM PAD)	0550330	340.0	-20.0
A05-R	FILTER, INDUCTION AIR	C294510-0401	1.0	-20.5
A09-R	ALTERNATOR, 28 VOLT, 60 AMP	C611502-0203	11.5	-5.5
A21-S	FILTER INSTALLATION, ENGINE FULL FLOW OIL ADAPTER ASSEMBLY, CONTINENTAL	1556019-2	3.0*	-7.0*
A33-R	FILTER ELEMENT, SPIN CN (GOLD COLOR)	641574	1.8	-7.0
A33-R	PROPELLER, CONSTANT SPEED (MCCAULEY, 2A36C202/90DCA-14)	C161009-0108	50.0	-41.0
A33-C	PROPELLER, FLOAT PLANE	C161009-0110	50.0	-41.0
A37-P	MCCAULEY, 2A34C203/90DCA-10	C161031-0108	3.0	-33.5
A41-S	GOVERNOR, PROPELLER (MCCAULEY, C290-D3/T15)	0530337	3.4*	-41.4*
A41-S	SPINNER, INSTALLATION, PROPELLER	0530338-1	1.5	-44.2*
A41-S	SPINNER, INSTALLATION, PROPELLER	0531054	4.3*	-2.3*
A41-S	VACUUM SYSTEM INSTALLATION	C431003-0102	1.8	-3.0
A70-R	VACUUM PUMP	1201075	0.2	4.7
A70-R	FILTER	C568509-0101	0.1	16.2
A73-O	RELIEF VALVE & REGULATOR	C482001-0401	0.4	12.5
A73-O	PRIMER SYSTEM, ENGINE		0.5	-
A73-O	OIL QUICK DRAIN VALVE (NET CHANGE)	1701015-3	0.5	-
B. LANDING GEAR & ACCESSORIES				
R01-P	WHEEL, BRAKE & TIRE ASSEMBLY, 600 X 6 MAIN (SET OF 2)	C163019-0202	42.5*	57.9*
R04-R	WHEEL ASSEMBLY (EACH)	C163006-0101	8.5	58.2
R04-R	BRAKE ASSEMBLY (LEFT)	C163032-0115	1.9	54.5
R04-R	BRAKE ASSEMBLY (RIGHT)	C163032-0116	1.9	54.5
R04-R	TIRE, 6-PLY BLACKWALL (EACH)	C262003-0204	8.7	58.2
R04-R	TIRE, (EACH)	C262022-0104	2.0	58.2*
R10-S	WHEEL & TIRE ASSEMBLY, NCSE	C163018-0104	8.6*	-6.8*
R10-S	WHEEL ASSEMBLY, MCCAULEY	C163005-0201	2.4	-6.8
R10-S	TIRE, 6 PLY BLACKWALL	C262003-0101	4.7	-9.0*
R10-S	TIRE, 6 PLY BLACKWALL	C262022-0101	1.2	-9.0*
R10-S	INSTALLATION, WHEEL (SET OF THREE)	0541225-3	17.8*	47.9
R10-S	FAIRING, WHEEL FAIRING		4.0	-

ITEM NO	EQUIPMENT LIST DESCRIPTION	REF DRAWING	WT LBS	ARM INS
	MAIN WHEEL FAIRING (EACH) BRAKE FAIRINGS (2)		5.7 0.6	60.3 55.0
	C. ELECTRICAL SYSTEMS			
C01-B	BATTERY, 24 VOLT (STANDARD CAPACITY)	C614002-0101	23.2	115.0
C01-D	BATTERY, 24 VOLT (HEAVY DUTY)	C614002-0102	25.2	115.0
C04-R	ALTERNATOR CONTROL UNIT WITH LOW VOLTAGE SENSING	C611005-0101	0.4	3.4
C07-A	GROUND SERVICE PLUG RECEPTACLE	0501058	2.7	24.4
C16-C	HEATED PITOT SYSTEM POST (NET CHANGE)	0422355-7	0.6	17.3
C22-A	LIGHTS, INSTRUMENT POST	0513094-20	0.5	21.5
C24-A	LIGHT, INSTALLED, CONTROL WHEEL MOUNTED	0501068	0.1	
C24-A	MAP (INSTALLED, WITH E89-0 ONLY)			
C24-S	LIGHT INSTALLATION, MAP & INSTRUMENT	0700149	0.3	32.0
C24-S	FLOOD--DROPOUT MOUNTED			
C31-A	LIGHTS, COURTESY (SET OF TWO)	0521191	0.5	61.0
C37-A	DEFLECTORS, NAVIGATION LIGHT (SET OF TWO)	0701013	0.0	
C43-A	LIGHT INSTALLATION, OMNIFLASH BEACON	0506003-5	1.4*	204.7*
	REACON LIGHT IN FEN TIP	C621001-0102	0.4	242.5
	FLASHER POWER SUPPLY IN VERTICAL TAIL	C505502-0102	0.6	205.1
	RESISTOR - MEMCOR (7174)	08955-6	0.6	208.3*
C44-A	LIGHT INSTALLATION, WING TIP, STROBE	0501027-1	3.4*	43.3*
	FLASHER POWER SUPPLY, WING TIP, RIB (2)	C622008-0102	2.3	40.8
C49-S	STROBE LIGHT, WING TIP (SET OF TWO)	C622006-0107	0.2	
	LIGHTS, LANDING, COWL MOUNTED - DUAL BULB	0501032	4.1	18.6
	D. INSTRUMENTS			
D01-R	INDICATOR, AIRSPEED	C661064-0104	0.6	16.0
D01-O	INDICATOR, TPUF AIRSPEED	0513279	0.7	16.3
D04-A	STATIC AIR, ALTERNATE SOURCE	0501017	0.2	15.5
D07-R	ALTITUDE, SENSITIVE (INCHES OF MERCURY)	C661071-0101	0.7	14.0
D07-O-1	ALTITUDE, SENSITIVE (FEET & MILLIBARS) (50 FT. MARKINGS)	C661071-0102	0.7	14.0
D07-O-2	ALTITUDE, SENSITIVE (FEET & MILLIBARS) (20 FT. MARKINGS)	C661025-0102	0.7	14.0
D10-A	ALTITUDE INSTALLATION - DUAL	2001015	1.0	14.0

SECTION 6
WEIGHT & BALANCE/
EQUIPMENT LIST

CESSNA
MODEL R172K

ITEM NO	EQUIPMENT LIST DESCRIPTION	REF DRAWING	WT LBS	ARM INS
D16-A-1	ALTIMETER, ENCODING (REQUIRES RELOCATION OF REGULAR TYPE ALTIMETER)	0501049	3.0	14.8
D16-A-2	ALTITUDE ENCODER (BLIND, DOES NOT REQUIRE INSTRUMENT PANEL MOUNTING)	0501059	1.5*	14.4*
D25-S	ENCODER	C744001-0101	1.3	14.6
D25-R	ELECTRIC DIGITAL READOUT	C664508-0102	0.4	16.3
D28-R	INSTALLATION, MAGNETIC COMPASS	C664511-0101	0.4	0.5
D38-R	INSTRUMENT CLUSTER, LH & RH FUEL	0513262-0101	0.4	26.0
D41-R	INSTRUMENT CLUSTER, CYL HEAD AND OIL TEMP	C6695338-0101	0.4	16.2
D43-R	INSTRUMENT CLUSTER, AMMETER & OIL PRES INDICATOR	C669527-0101	0.5	16.2
D49-A	ECONOMY MIXTURE (E.G.T.)	0501043	0.6	17.8
D55-R	GAGE, MANIFOLD PRESSURE & FUEL FLOW	C662037-0108	1.1*	16.5
D64-S	GYRO, INSTALLATION, ATTITUDE & DIRECTIONAL (NON NAV-O-MATIC)	0501054	1.6	13.6*
D64-R	DIRECTIONAL INDICATOR	C661075-0104	2.7	14.7
D64-O	ATTITUDE INDICATOR	C661076-0101	2.5*	13.4*
D67-A	GYRO INSTALLATION FOR 300 NAV-O-MATIC (ARC)	0501054	3.2	14.3
D82-S	DIRECTIONAL INDICATOR	40760-0101	2.5	14.3
D85-R	ATTITUDE LIGHT HOUR	C651076-0101	0.5	6.3
D88-S-1	RECORDER, FLIGHT AIR TEMP (C668507-0101)	0500221	0.1*	28.6*
D88-S-2	GAGE, OUTSIDE AIR TEMP	0506005	1.0	13.0
D89-O	TACHOMETER INSTALLATION	C661003-0505	1.3	15.8
D91-A	RECORDING TACH HEAD TURN COORDINATOR (28 VOLT OPERATION) TURN COORDINATOR (10 TO 30 VOLT) USE TURN COORDINATOR (FOR AUTO-PILOT USE) INDICATOR, VERTICAL SPEED	C661003-028 42320-0028 C661080-0101	1.3 1.3 1.0	15.8 15.8 15.7
E05-R	E. CABIN ACCOMMODATIONS	0514168	12.6	44.0
E05-O	SEAT, ADJUSTABLE FORE & AFT, PILOT	0514171	13.6	41.5
E07-S	SEAT, INFINITE ADJUSTING, PILOT	0514168	13.6	41.5
E07-O	SEAT, ADJUSTABLE FORE & AFT, CO-PILOT	0514171	13.6	41.5
E09-S	SEAT, INFINITE ADJUSTING, CO-PILOT	0514169	22.0	79.3
E09-O	SEAT, REAR (CONE PIECE BACK CUSHION)	0514170	23.0	79.3
E15-R	SEAT, REAR (TWO PILOT LAP CUSHION)	S-2275-103	1.0	37.0
E15-O	BELT ASSEMBLY, PILOT LAP	S-2275-201	1.0	37.0
E19-S	SHOULDER ASSEMBLY, PILOT	0501046-1	2.0	82.0
E19-O	INERTIA REEL-SEAT BELT INSTALLATION,			

ITEM NO	EQUIPMENT LIST DESCRIPTION	REF DRAWING	WT LBS	ARM INS
E23-S	PILOT & CO-PILOT (NET CHANGE)			
E27-S	SEAT & SHOULDER HARNESS ASSY, CO-PILOT		1.6	37.0
E27-O	SEAT BELT ASSEMBLY, REAR (SET OF TWO)	S-1746-13	12.0	70.0
E33-O	BELT & SHOULDER HARNESS ASSY, 2ND ROW (2)	S-2275-8	3.0	70.0
E35-A-1	CARPETTING, BLACK, VINYL, NET CHANGE		0.0	-
E35-A-2	SEAT COVERING, VINYL, NET CHANGE		0.0	-
E37-A	SEAT COVERING, LEATHER, NET CHANGE	CES-1151	6.7	67.0
E37-O	WINDOWS, RIGHT DOOR HINGED (NET CHANGE)	0501075	2.3	47.9
E43-A	VENTILATION SYSTEM, BEAR (NET INCREASE)	0511800	0.7	50.9
E46-A	CUP HOLDER, RETRACTABLE (SET OF TWO)	0700322	1.7	50.5
E50-A	HEADREST, FRONT (SET OF TWO)	0301023	1.5	17.0
E51-S	HEADREST, REAR (SET OF 2)	12115073	1.5	86.0
E57-O	SUN VISORS, S (SET OF 2)	0514166	0.5	32.8
E65-R	TINTED GLASS (ALL AROUND) (NET CHANGE)	2015009-8	0.5	95.0
E71-A	RAGGAGE TIE DOWN NET	0500042	1.0	95.0
E71-A	CONTROLS, CARGO TIE DOWN	0513335	1.0	12.4*
E71-A	CONTROLS, DUAL (CO-PILOT'S WHEEL, PEDALS AND TOP BRAKES)		4.9*	
E87-S	CONTROL WHEEL WITH PROTECTIVE PADDING		2.0	26.0
E88-A	RUDDER PEDAL (SET OF TWO)	0510402	1.1	6.8
E89-O	RUDDER TRIM SYSTEM	0513290	1.9	9.4
	CABIN AIR CIRCULATING FAN (CANNOT BE USED WITH E43-A)	0501072	10.0	100.0
	ALL PURPOSE CONTROL WHEEL, NET CHANGE	0501068	NEGL	-
	F. PLACARDS, WARNINGS & MANUALS			
F01-R	PLACARD, OPERATIONAL LIMITATIONS VFR DAY	0505087	0.0	-
F01-O-1	PLACARD, OPERATIONAL LIMITATIONS VFR DAY - NIGHT	0505087	0.0	-
F01-O-2	PLACARD, OPERATIONAL LIMITATIONS IFR DAY - NIGHT	0505087	0.0	-
F04-R	STALL WARNING HORN (PNEUMATIC)	0523112	0.5	28.5
F10-S	PILOTS CHECK LIST (STANDARD A/C) (STOWED)	0505063	0.0	-
F10-O-1	PILOTS CHECK LIST (200A NAV-O-MATIC)		0.0	-
F10-O-2	PILOTS CHECK LIST (300A NAV-O-MATIC)		0.0	-
F16-R	PILOT'S OPERATING HANDBOOK AND FAA APPROVED AIRPLANE FLIGHT MANUAL	0505066 01173-13PH	0.5	-

SECTION 6
WEIGHT & BALANCE/
EQUIPMENT LIST

CESSNA
MODEL R172K

ITEM NO	EQUIPMENT LIST DESCRIPTION	REF DRAWING	WT LBS	ARM INS
	G. AUXILIARY EQUIPMENT			
G07-A	RINGS, AIRPLANE HOISTING	0541115	1.0	49.0
G13-A	CORROSION PROTECTANT, INTERNAL	0500036	10.4	77.0
G16-A	STATIC DISCHARGER, INSTALLATION (SET OF 10)	0501048	0.7	143.0
G18-A	STABILIZER ARRASION BOOTS	0500041	2.0	206.0
G22-S	TOW BAR (STOWED)	0501019	1.5*	95.0*
G25-S	PAINT SCHEME, OVERALL EXTERIOR COVER OVERALL SCHEME, BASE WHITE STRIPES CORROSION RESISTANT CONTROL (NET CHANGE)	0504040	11.6	90.5*
G31-A	CABLES, CORROSION RESISTANT CONTROL (NET CHANGE)	0500036	0.0	88.8
G55-A-1	FIRE EXTINGUISHER, STD PILOT SEATING	0501011	3.0	45.5
G55-A-2	FIRE EXTINGUISHER, VTL ADJ PILOT SEAT	2401011	3.2	29.0
G59-A	STEPS AND HANDLE, REFUELING - SET	0513415	1.7	17.8
G67-A	RUDDER, PEDAL EXTENSIONS, REMOVABLE - SET OF 2 (STOWABLE - INSTALLED) (NOT FACTORY INSTALLATION)	0701048	2.3	18.0
G89-A	WINTERIZATION KIT INSTALLATION, ENGINE COVER PLATE, FWD CCWL (INSTALLED)	0501007-1	1.0*	-24.3*
G92-0	COVER PLATE, FWD CCWL (STCWED) EXTENDED RANGE WINGS (WET WING) NET CHANGE	0552132	0.4	-32.0
		0501063	0.4	95.0
			-21.4	46.6
	H. AVIONICS & AUTOPILOTS			
H01-A	CESSNA 300 ADF INSTALLATION CONSISTS OF-- RECEIVER WITH BFO (R-546E-1) INDICATOR (IN-246A)	3910159-2	8.0*	19.9*
	SENSE ANTENNA INSTALLATION	41420-0001	3.3	12.1
	LOOP ANTENNA INSTALLATION	40980-1001	0.9	14.0
	RECEIVER MOUNT, WIRES AND MISC ITEMS	0570400-632	0.2	108.6
H04-A	DME INSTALLATION, MARCO TRANSMITTER (DME-190) MOUNT ASSY	3910166	1.2	13.7
	ANTENNA INSTALLATION	3312-406	7.5*	12.5*
H05-A	FOSTER 511 R-NAV INSTALLATION	3910203-1	0.6	11.3
	RECEIVER & MOUNT		0.2	86.1
H07-A	CESSNA 400 GLIDESLOPE (INCLUDES VOR/ILS)	3910157	3.4*	11.8*
			4.4*	14.5
				81.1*

ITEM NO	EQUIPMENT LIST DESCRIPTION	REF DRAWING	WT LBS	ARM INS
	INDICATOR--EXCHANGE FOR VGR/LOC) RECEIVER (R-442B) UPPER WINDSHIELD) ANTENNA (LOCATED) VOR/ILS INDICATOR ADDED VOR/LOC INDICATOR DELETED AUTO RADIAL CENTERING INDICATOR ARC/LOC EXCHANGE FOR VOR/LOC IN ITEM H22-A AND H25-A (WT NET CHANGE) ARC/LOC INDICATOR ADDED VOR/LOC INDICATOR DELETED AUTO RADIAL CENTERING INDICATOR ARC/ILS EXCHANGE FOR VOR/ILS. ONLY, WT NET CHANGE ARC/ILS INDICATOR ADDED VOR/ILS INDICATOR DELETED PANTRONICS PTL0-A HF TRANSCIEVER, 2ND DR 3RD UNIT TRANSCIEVER (PANEL MOUNTED) ANTENNA LOAD BOX HF POWER SUPPLY (REMOTE) POWER & SIGNAL CABLES ANTENNA INSTALLATION, 351 IN. LONG SUNAIR ASB-125 HF TRANSCIEVER, 2ND DR 3RD UNIT ANTENNA LOAD BOX POWER SUPPLY (REMOTE) TRANSCIEVER (PANEL MOUNTED) ANTENNA INSTALLATION, 351 IN. LCNG CESSNA 400 MARKER BEACON RECEIVER (R-402A) ANTENNA, L SHAPED ROD CFSSNA 300 TRANSPONDER TRANSCIEVER (RT-359A) ANTENNA CFSSNA 400 TRANSPONDER TRANSCIEVER (RT-459A) ANTENNA CFSSNA 300 NAV/COM, 720 CH, COM, 1ST UNIT REQUIRES H34-6 TO BE OPERATIONAL RECEIVER-TRANSCIEVER (RT-385A) VOR/LOC INDICATOR (IN -385A) MOUNT, WIRING & MISC ITEMS	42100-0000 1200098 46860-2000 46860-1000 46860-1200 46860-1000 46860-2200 3910193-2 C582103-0102 C589502-0201 C582103-0301 3950122-15 3960117-3 3910158-1 99816 99683 99681 3960117-3 3910164-1 4241055128 1770681-17 3910127-17 41420-0028 42940-0000 3910128-21 41470-1028 42940-0000 3910183 46660-1000 46660-1000	2.1 3.7 1.7 -1.6 -0.2* 1.8 -0.1* 1.9 -1.8 20.1* 4.2 4.5 8.5 2.5 0.3 22.0* 4.9 8.5 4.6 0.3* 0.7 0.7* 2.7 0.3* 2.9 4.2 8.3* 5.5 1.6 1.2	117.0 130.7 14.7 14.7* 14.7* 14.7 14.7* 14.7* 14.7 14.7 89.3* 10.4 112.5 14.4 14.1 14.6 83.8* 112.0 114.0 10.4 134.4* 134.5* 136.0 135.8* 11.1 127.0* 125.1* 11.1 127.0* 11.9* 11.5 14.7 10.0
H08-A-1				
H08-A-2				
H11-A-1				
H11-A-2				
H13-A				
H16-A-1				
H16-A-2				
H22-A				

*Removed
12/5/2006*

SECTION 6
WEIGHT & BALANCE/
EQUIPMENT LIST

CESSNA
MODEL R172K

ITEM NO	EQUIPMENT LIST DESCRIPTION	REF DRAWING	WT LBS	ARM INS
H25-A	CESSNA 300 NAV/COM 720 CH COM 2MD UNIT REQUIRES H27-A TO BE OPERATIONAL RECEIVER-TRANSCIVER (RT-385A) VOR/LOC INDICATOR (IM-385A) MOUNT, WIRING & MISC ITEMS RECEIVER-TRANSCIVER (RT-385A) EMERGENCY LOCATER TRANSMITTER TRANSMITTER (D & M DMELT-6-1) ANTENNA EMERGENCY LOCATOR TRANSMITTER (USED IN CANADA) TRANSMITTER (D & M DMELT-6-1C) ANTENNA	3910183 46560-1000 46860-1000 46560-1100 7470419-3 C589511-0117 C589511-0109 7470419-4 C589511-0113 C589511-0109 3910122-9 3930144-2 42320-0028 3970143 0522632-4	8.3* 5.5 1.6 5.5* 3.3 3.5 3.5	11.9* 11.5 14.0 11.5* 116.4 116.0* 116.5*
H28-A-1	NAV-G-MATIC 200A CONTROLLER & MOUNT (CA-295B) TURN COORDINATOR (NET CHNG) (G-300A) RELAY INSTALLATION (SERVO IS 3.9 LBS AT WING INSTALLATION (SERVO IS 3.9 LBS AT 68.9 INCHES)(PA-495) NAV-G-MATIC 200A (AF395) CONTROLLER-AMPLIFIER & MOUNT (CA-395A) GYRD INSTALLATION (D64-A-2) (NET CHNG) TURN COORDINATOR (NET CHNG) RELAY INSTALLATION (NET CHANGE) RELAY INSTALLATION (SERVO IS 3.9 LBS AT WING INSTALLATION (SERVO IS 3.9 LBS AT 68.9 INCHES)(PA-495) MISC WIRING & HARDWARE ITEMS	3910163-9 3930145-19 0501052 42320-0028 3970143 0522632-5 42730-4008 3910186-3 3930208 3940148-1 3950122-3	10.3* 1.8 0.6 0.6 2.4 6.1	46.4* 13.1 11.3 4.0 68.1
H34-A	BASIC AVIONICS KIT INSTALLATION RADIO COOLING INSTALLATION NOISE FILTER INSTALLATION COM ANTENNA CABLE, LH VHF OMNI ANTENNA COM ANTENNA, LH VHF COM ANTENNA, INSTL CABIN SPEAKER, INSTL MIKE INSTL, HAND HELD HEADPHONE INSTL (STOWED ARM SHOWN) AUDIO CONTROL PANEL INSTL COM ANTENNA & OMNI COUPLER KIT COM ANTENNA CABLE, COUPLER VHF OMNI ANTENNA COUPLER (SIGNAL SPLITTER) COM ANTENNA, RH VHF	3960102-10 3960113-1 3970123-5 3970124-5 3970125-4 3970143 3910185 3960122-3 3960111-3 3960113-2	1.5* 17.0* 1.1 1.1 0.6 0.8 0.4 0.2 0.3 1.0 1.0 0.4 0.2	25.9* 52.0* 10.2 10.2 27.8 16.0 22.8 32.9 17.2 14.2 15.0* 12.8 7.0 6.4
H37-A	COM ANTENNA CABLE, COUPLER VHF OMNI ANTENNA COUPLER (SIGNAL SPLITTER) COM ANTENNA, RH VHF	3960102-10 3960113-1 3970123-5 3970124-5 3970125-4 3970143 3910185 3960122-3 3960111-3 3960113-2	1.5* 17.0* 1.1 1.1 0.6 0.8 0.4 0.2 0.3 1.0 1.0 0.4 0.2	25.9* 52.0* 10.2 10.2 27.8 16.0 22.8 32.9 17.2 14.2 15.0* 12.8 7.0 6.4

ITEM NO	EQUIPMENT LIST DESCRIPTION	REF DRAWING	WT LBS	ARM INS
H43-A	AVIONICS OPTION D NAV-G-MATIC WING PROV.	0522632-2	1.7	68.2
H45-A	MIKE-HEADSET COMBO INSTL (HEADSET STOWED) (REQUIPES ALL PURPOSE CONTROL WHEEL, ITEM E89-A)	C596530-0101	0.3	13.0
H46-A	MICROPHONE/HEADSET, PADDED (STOWED) (REQUIPES ALL PURPOSE CONTROL WHEEL, ITEM E89-A)	C596531-0101	1.1	-
J. SPECIAL CRITCN PACKAGES				
J01-A	HAWK-XP II EQUIPMENT CONSISIS OF ITEMS C16-0 HEATED PITOT SYSTEM C31-A COURTESY LIGHTS C40-A NAV LIGHT DETECTORS C43-A FLASHING BEACCN LIGHT D01-0 TRUE AIRSPEED IND. (NET CHANGE) E04-A STATIC AIR, ALTERNATE SOURCE F04-A DUAL CONTROLS G16-A STATIC DISCHARGERS H28-A NAV/COM RT-285A VCR/LDC H34-A-1 EMERGENCY LOCATER TRANSMITTER H34-A BASIC AVIONIC KIT NAV-PAC INSTALLATION (AVAILABLE XP II) H01-A-1 300 TRANSPONDER (RT-359A) H16-A-1 300 NAV/COM, 2ND UNIT H25-A 300 NAV/COM, 2ND COUPLER KIT H37-A COM ANT AND NAV COUPLER KIT F10-A FUSELAGE STRUCTURAL MODIFICATION- F10-A FITTINGS (FLOATPLANE OPTION C) F10-A FLOATPLANE COWLDECK V BRACE (INSTALLED) F10-A FLOATPLANE ALLERON-RUDDER INTERCONNECT F10-A FLOATPLANE ONLY (INSTALLED) F10-A FLOATPLANE ONLY (STOWED)	0500511 0422355-7 0521101 0731013 0506003-3 0513279 0501017 0506005 3910183 0470519 3910186 3910159-2 3910127-17 3910185 0500044-45 0513003 0550012	26.9* 0.6 0.5 NEGL 1.4 0.1 0.2 0.4 0.3 3.5 7.0 21.3* 8.0 4.0 8.3 1.9 1.1 1.1	49.5* 24.4 61.0 204.7 18.3 15.4 12.2 143.2 11.5 116.5 152.9 18.0 19.0 25.8 11.9 25.0 43.0 26.2 95.0
J04-A	NAV-PAC INSTALLATION (AVAILABLE XP II)	3910183	8.0	18.0
J04-A	H16-A-1 300 TRANSPONDER (RT-359A)	0470519	4.0	11.5
J04-A	H25-A 300 NAV/COM, 2ND UNIT	3910186	3.5	116.5
J04-A	H37-A COM ANT AND NAV COUPLER KIT	3910159-2	7.0	152.9
J10-A	F10-A FUSELAGE STRUCTURAL MODIFICATION- FITTINGS (FLOATPLANE OPTION C)	3910127-17	8.3	18.0
J10-A	F10-A FLOATPLANE COWLDECK V BRACE (INSTALLED)	3910185	1.9	25.0
J13-A	F10-A FLOATPLANE ALLERON-RUDDER INTERCONNECT (INSTALLED)	0500044-45	1.1	11.9
J13-A	F10-A FLOATPLANE ONLY (STOWED)	0513003	1.1	25.0
J15-A	F10-A FLOATPLANE ONLY (INSTALLED)	0550012	1.1	95.0
J27-A	ITEMS J10-A & J13-A ARE ALSO APPROVED FOR LANDPLANE OPERATIONS AND ATTACHMENTS MODEL 248B-2440 FLOATS AND STANDARD LANDING NET CHANGE BETWEEN MODEL 248B-2440 FLOAT- GEAP (ITEM NOS. B01-8, B04-8, B10-8, AND BRAKE & NOSE WHEEL STEERING SYS-	EDO 248B-2440	-	-

SECTION 6
WEIGHT & BALANCE/
EQUIPMENT LIST

CESSNA
MODEL R172K

ITEM NO	EQUIPMENT LIST DESCRIPTION	REF DRAWING	WT LBS	ARM INS
J20-A-1	<p>F15-A-1 IS APPROXIMATELY 235 LBS AT 43.2 IN. THE CORRECT VALUES OF WT & ARM CHANGE FOR WT & BALANCE CALCULATION SHOULD BE DETERMINED FROM ACTUAL INSTALLATION WEIGHING. COMPLETE--WITH INSTALLATION EQUIPMENT KIT. COMPLETE--WITH PROPELLER & CORROSION PROTECTING--EXCHANGE A33-C-0 FLOAT PLANE OPERATIONS EXCHANGE F01-F-0 PLACARD, FLOAT PLANE OPERATIONS EXCHANGE G21-A CORROSION RESIS, EXCH. G13-A CORROSION PROTECTING, INTERNAL G57-A RINGS & HANDLE, REFUELING G58-A FUSELAGE MODIFICATIONS J10-A COWL DECK BRACE (INSTALLED) J15-A INTERCONNECT RUDDER-AILERON INSTALLED RUDDER CONTROL SPRINGS (STOWED, INSTALLED ARM SHOWN) NOSE STRUT STUB (STOWED, INSTALLED ARM SHOWN) COMPLETE--WITH PROPELLER & CORROSION PROTECTING--EXCHANGE A33-D PROPELLER OPERATIONS PLACARD F01-D-0 FLOAT PLANE OPERATIONS EXCHANGE G07-A RINGS & HANDLE, REFUELING J10-A FUSELAGE STRUCTURE MODIFICATION J15-A COWL DECK BRACE--INSTALLED INTERCONNECT RUDDER-AILERON INSTALLED</p>	<p>0501065 0500036 0500036 0513415 0500044 0513003 0560012</p>	<p>26.8* 0.0 NEGL 10.0 1.1 1.7 1.9 1.1 0.5 1.2 3.3 16.8*</p>	<p>56.3* - - 77.0 49.1 17.8 43.0 60.1 220.5 -3.0 43.2*</p>
J30-A-2	<p>FLOAT PLANE EQUIPMENT KIT, COMPLETE--WITH PROPELLER & CORROSION PROTECTING--EXCHANGE A33-D PROPELLER OPERATIONS PLACARD F01-D-0 FLOAT PLANE OPERATIONS EXCHANGE G07-A RINGS & HANDLE, REFUELING J10-A FUSELAGE STRUCTURE MODIFICATION J15-A COWL DECK BRACE--INSTALLED INTERCONNECT RUDDER-AILERON INSTALLED</p>	<p>0501065 0541115 0513415 0500044 0513003 0560012</p>	<p>0.0 NEGL 1.7 7.9 1.1 0.5 1.2 3.3 12.3</p>	<p>- - 49.1 17.8 43.0 28.2 60.1 210.5 -3.0 45.4*</p>
J30-A-3	<p>RUDDER CONTROL SPRINGS (STOWED) NOSE STRUT (STOWED, INSTALLED ARM SHOWN) COMPLETE--WITH PROPELLER & CORROSION PROTECTING--EXCHANGE A33-E PROPELLER OPERATIONS PLACARD F01-E-0 FLOAT PLANE OPERATIONS EXCHANGE G07-E RINGS & HANDLE, REFUELING J10-E FUSELAGE MODIFICATIONS J15-E COWL DECK BRACE (INSTALLED) INTERCONNECT RUDDER-AILERON INSTALLED</p>	<p>0501065 0541115 0513415 0500044 0513003 0560012</p>	<p>NEGL 1.1 1.7 1.9 1.1 7.9</p>	<p>- - 49.1 17.8 43.0 17.8 43.0</p>

ITEM NO	EQUIPMENT LIST DESCRIPTION	REF DRAWING	WT LBS	ARM INS
J30-A-4	J13-A COWL DECK BRACE--STOWED J15-A INTERCONNECT SYSTEM (STOWED) INSTALL ARM SHCWN FLOATPLANE KIT WITH CORROSION PROOFING BUT NO PROP CHANGE F01-0- FLOATPLANE OPERATIONS PLACARD G07-A AIRPLANE HOISTING PROVISIONS G13-A CORROSION PROOFING, INTERNAL G31-A CORROSION RESISTANT CONTROL CABLES J10-A FUSELAGE MODIFICATIONS J13-A COWL DECK BRACE--STOWED J15-A INTERCONNECT SYSTEM (STOWED) INSTALL ARM SHOWN G58-A STEP & HANDLE, REFUELING	0513003 0560012 0501065-5 0541115 0500036 0500044 0213003 0560012 0513415	1.1 0.5 22.3* NEGL 1.1 10.0 NEGL 7.9 1.1 0.5 1.7 2.0	95.0 60.1 59.6* -- 49.1 77.0 -- 43.0 95.0 60.1 17.8 11.1
	Garmin 6-IX-327 Transponder			

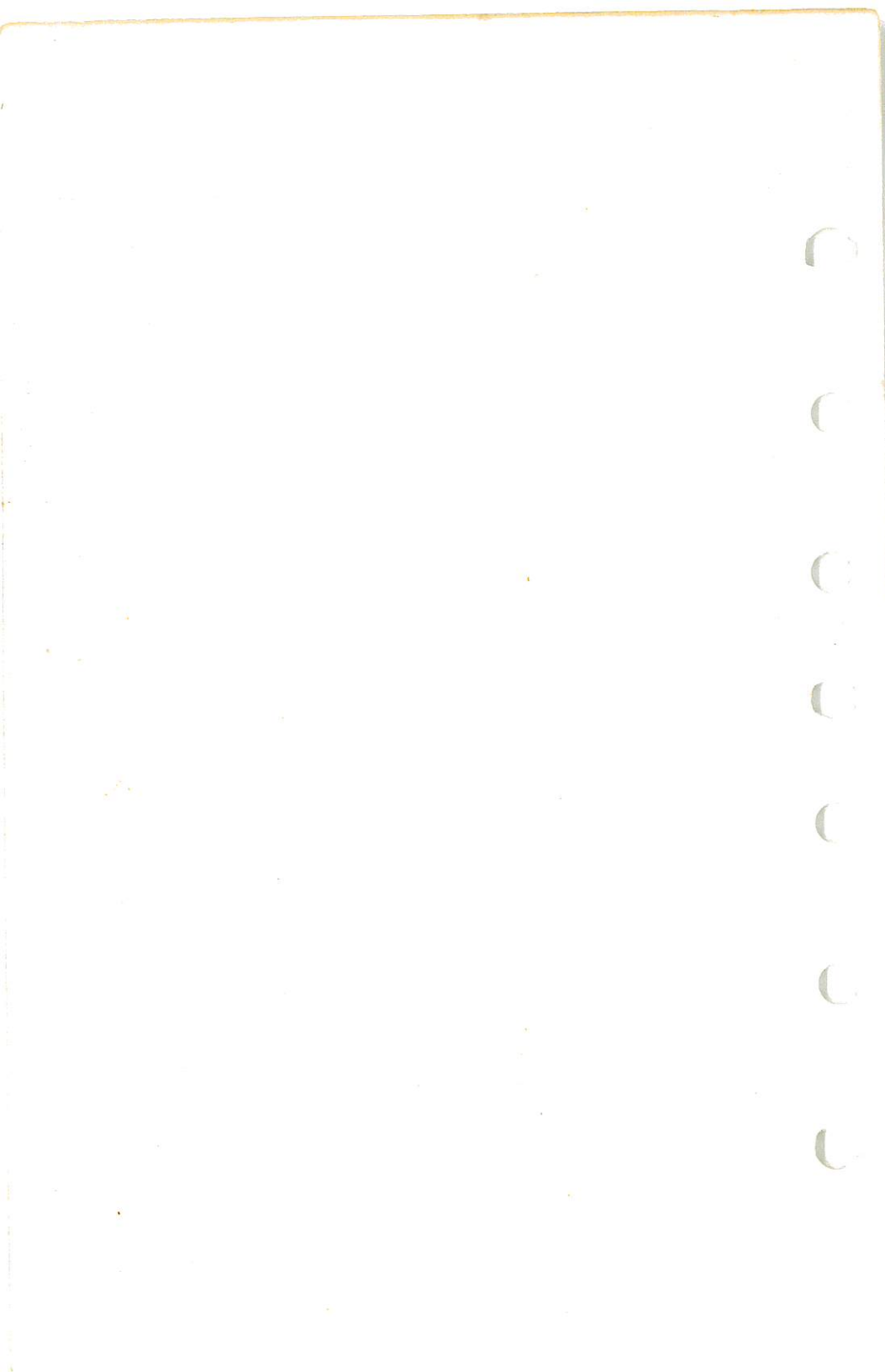

SECTION 7 AIRPLANE & SYSTEMS DESCRIPTIONS

TABLE OF CONTENTS

	Page
Introduction	7-3
Airframe	7-3
Flight Controls	7-8
Trim Systems	7-8
Instrument Panel	7-8
Ground Control	7-9
Wing Flap System	7-10
Landing Gear System	7-10
Baggage Compartment	7-11
Seats	7-11
Seat Belts And Shoulder Harnesses	7-12
Seat Belts	7-12
Shoulder Harnesses	7-14
Integrated Seat Belt/Shoulder Harnesses With Inertia Reels	7-14
Entrance Doors And Cabin Windows	7-15
Control Locks	7-16
Engine	7-16
Engine Controls	7-16
Engine Instruments	7-17
New Engine Break-In And Operation	7-18
Engine Oil System	7-18
Ignition-Starter System	7-19
Air Induction System	7-19
Exhaust System	7-20
Fuel Injection And Manual Priming Systems	7-20
Cooling System	7-20
Propeller	7-21
Fuel System	7-21
Brake System	7-26
Electrical System	7-26
Master Switch	7-28
Avionics Power Switch	7-28
Ammeter	7-29

TABLE OF CONTENTS (Continued)

	Page
Alternator Control Unit and Low-Voltage Warning Light . . .	7-29
Circuit Breakers And Fuses	7-30
Ground Service Plug Receptacle	7-30
Lighting Systems	7-30
Exterior Lighting	7-30
Interior Lighting	7-31
Cabin Heating, Ventilating And Defrosting System	7-32
Pitot-Static System And Instruments	7-34
Airspeed Indicator	7-34
Vertical Speed Indicator	7-35
Altimeter	7-35
Vacuum System And Instruments	7-35
Attitude Indicator	7-35
Directional Indicator	7-37
Suction Gage	7-37
Stall Warning System	7-37
Avionics Support Equipment	7-37
Audio Control Panel	7-38
Transmitter Selector Switch	7-38
Audio Selector Switches	7-38
Com Auto Audio Selector Switch	7-40
Com Both Audio Selector Switch	7-40
Auto Audio Selector Switch	7-41
Annunciator Lights Brightness And Test Switch	7-41
Sidetone Operation	7-42
Microphone - Headset Installations	7-42
Static Dischargers	7-43

INTRODUCTION

This section provides description and operation of the airplane and its systems. Some equipment described herein is optional and may not be installed in the airplane. Refer to Section 9, Supplements, for details of other optional systems and equipment.

AIRFRAME

The airplane is an all-metal, four-place, high-wing, single-engine airplane equipped with tricycle landing gear and designed for general utility purposes.

The construction of the fuselage is a conventional formed sheet metal bulkhead, stringer, and skin design referred to as semimonocoque. Major items of structure are the front and rear carry-through spars to which the wings are attached, a bulkhead and forgings for main landing gear attachment at the base of the rear door posts, and a bulkhead with attach fittings at the base of the forward door posts for the lower attachment of the wing struts. Four engine mount stringers are also attached to the forward door posts and extend forward to the firewall.

The externally braced wings, containing the fuel tanks, are constructed of a front and rear spar with formed sheet metal ribs, doublers, and stringers. The entire structure is covered with aluminum skin. The front spars are equipped with wing-to-fuselage and wing-to-strut attach fittings. The aft spars are equipped with wing-to-fuselage attach fittings, and are partial-span spars. Conventional hinged ailerons and single-slotted flaps are attached to the trailing edge of the wings. The ailerons are constructed of a forward spar containing balance weights, formed sheet metal ribs and "V" type corrugated aluminum skin joined together at the trailing edge. The flaps are constructed basically the same as the ailerons, with the exception of the balance weights and the addition of a formed sheet metal leading edge section.

The empennage (tail assembly) consists of a conventional vertical stabilizer, rudder, horizontal stabilizer, and elevator. The vertical stabilizer consists of a spar, formed sheet metal ribs and reinforcements, a wrap-around skin panel, formed leading edge skin, and a dorsal. The rudder is constructed of a formed leading edge skin containing hinge halves, a center wrap-around skin panel, ribs, an aft wrap-around skin panel which is joined at the trailing edge of the rudder by a filler strip, and a ground adjustable trim tab at the base of the trailing edge. The top of the rudder incorporates a leading edge extension which contains a balance weight. The horizontal stabilizer is constructed of a forward and aft spar, ribs and

AILERON CONTROL SYSTEM

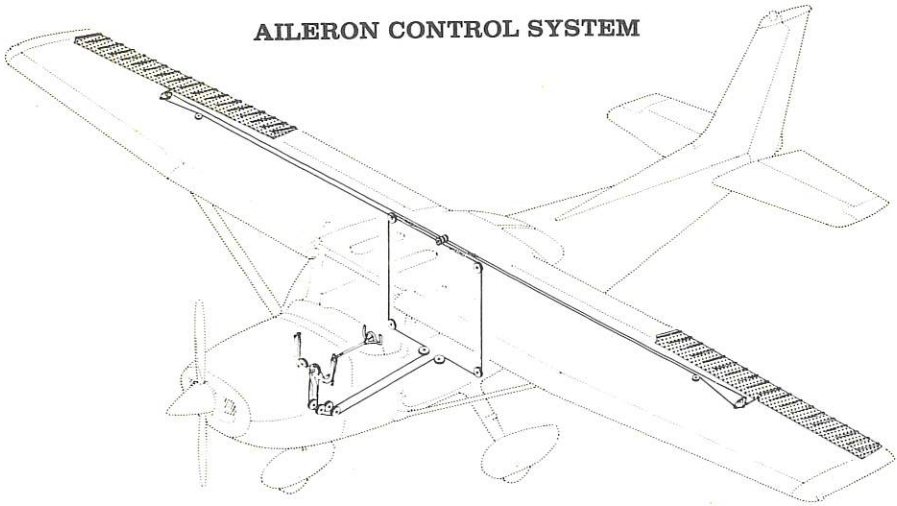

RUDDER AND RUDDER TRIM CONTROL SYSTEMS

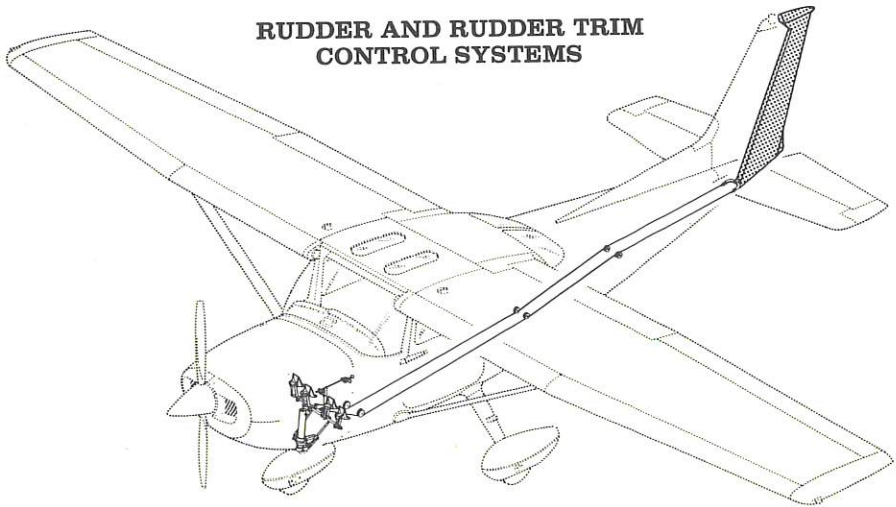
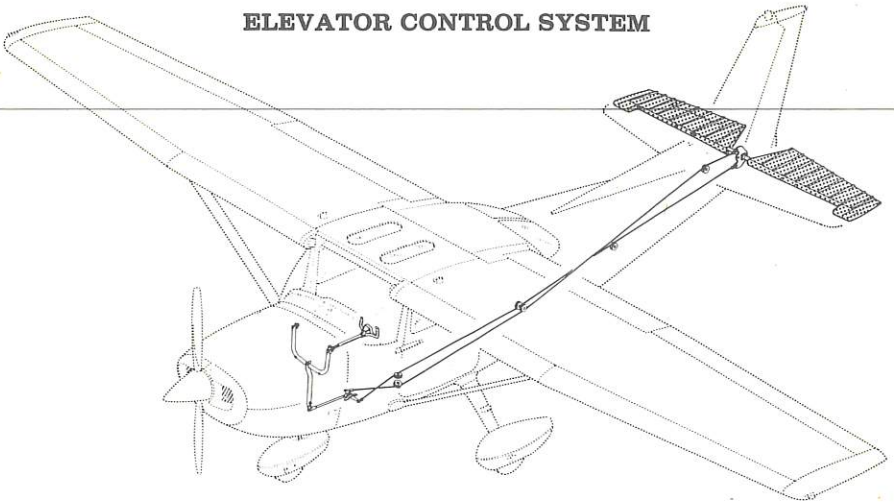

Figure 7-1. Flight Control and Trim Systems (Sheet 1 of 2)

ELEVATOR CONTROL SYSTEM



ELEVATOR TRIM CONTROL SYSTEM

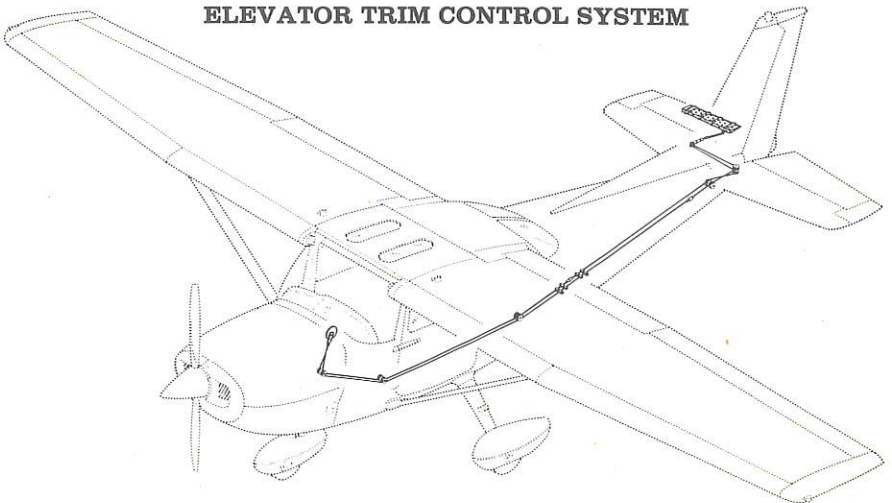

Figure 7-1. Flight Control and Trim Systems (Sheet 2 of 2)

SECTION 7
 AIRPLANE & SYSTEMS DESCRIPTIONS

CESSNA
 MODEL R172K

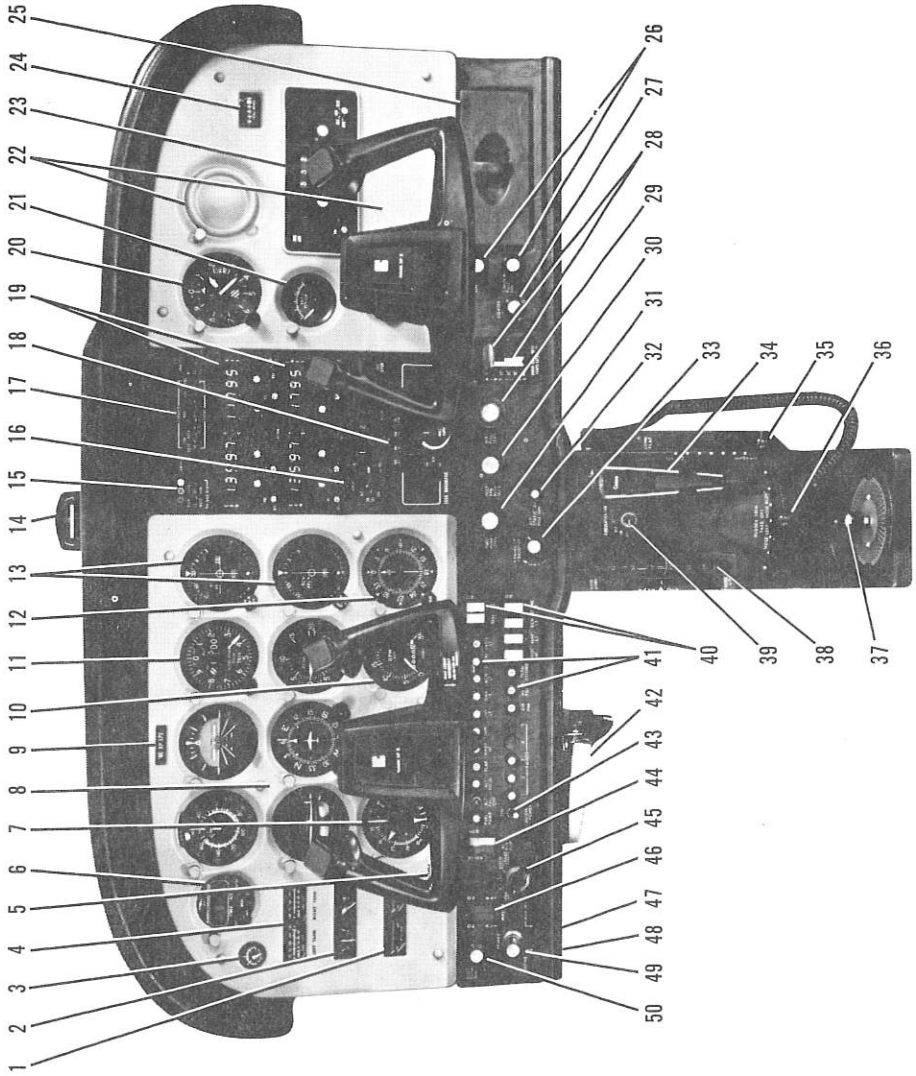

Figure 7-2. Instrument Panel (Sheet 1 of 2)

- | | | | |
|-----|---|-----|---|
| 1. | Cylinder Head Temperature and Oil Temperature Gages | 25. | Map Compartment |
| 2. | Ammeter and Oil Pressure Gage | 26. | Cabin Heat and Air Control Knobs |
| 3. | Suction Gage | 27. | Cigar Lighter |
| 4. | Left Tank and Right Tank Fuel Quantity Indicators | 28. | Wing Flap Switch and Position Indicator |
| 5. | Low-Voltage Warning Light | 29. | Mixture Control Knob |
| 6. | Digital Clock | 30. | Propeller Control Knob |
| 7. | Manifold Pressure/Fuel Flow Indicator | 31. | Throttle (With Friction Lock) |
| 8. | Flight Instrument Group | 32. | Static Pressure Alternate Source Valve |
| 9. | Airplane Registration Number | 33. | Instrument and Radio Dial |
| 10. | Tachometer | 34. | Light Dimming Rheostats |
| 11. | Encoding Altimeter | 35. | Microphone |
| 12. | ADF Bearing Indicator | 36. | Cowl Flap Control Lever |
| 13. | Course Deviation Indicators | 37. | Rudder Trim Control Lever |
| 14. | Magnetic Compass | 38. | Fuel Selector Valve Handle |
| 15. | Marker Beacon Indicator | 39. | Elevator Trim Control Wheel |
| 16. | Lights and Switches | 40. | Circulation Fan Control |
| 17. | Transponder | 41. | Electrical Switches |
| 18. | Audio Control Panel | 42. | Circuit Breakers |
| 19. | Autopilot Control Unit | 43. | Parking Brake Handle |
| 20. | Radios | 44. | Avionics Power Switch |
| 21. | Secondary Altimeter | 45. | Auxiliary Fuel Pump Switch |
| 22. | Economy Mixture Indicator | 46. | Ignition Switch |
| 23. | Additional Instrument and Radio Space | 47. | Master Switch |
| 24. | ADF Radio | 48. | Auxiliary Mike Jack |
| | Flight Hour Recorder | 49. | Phone Jack |
| | | 50. | Primer |
| | | | Fuel Shutoff Control Knob |

Figure 7-2. Instrument Panel (Sheet 2 of 2)

stiffeners, center, left, and right wrap-around skin panels, and formed leading edge skins. The horizontal stabilizer also contains the elevator trim tab actuator. Construction of the elevator consists of formed leading edge skins, a forward spar, aft channel, ribs, torque tube and bellcrank, left upper and lower "V" type corrugated skins, and right upper and lower "V" type corrugated skins incorporating a trailing edge cut-out for the trim tab. The elevator trim tab consists of a spar, rib, and upper and lower "V" type corrugated skins. The leading edge of both left and right elevator tips incorporate extensions which contain balance weights.

FLIGHT CONTROLS

The airplane's flight control system (see figure 7-1) consists of conventional aileron, rudder, and elevator control surfaces. The control surfaces are manually operated through mechanical linkage using a control wheel for the ailerons and elevator, and rudder/brake pedals for the rudder.

Extensions are available for the rudder/brake pedals. They consist of a rudder pedal face, two spacers and two spring clips. To install an extension, place the clip on the bottom of the extension under the bottom of the rudder pedal and snap the top clip over the top of the rudder pedal. Check that the extension is firmly in place. To remove the extensions, reverse the above procedures.

TRIM SYSTEMS

Manually-operated rudder and elevator trim systems are provided. Rudder trimming is accomplished through a bungee connected to the rudder control system and a trim lever, mounted on the control pedestal. Rudder trimming is accomplished by lifting the trim lever up to clear a detent, then moving it either left or right to the desired trim position. Moving the trim lever to the right will trim the airplane nose-right; conversely, moving the lever to the left will trim the airplane nose-left. Elevator trimming is accomplished through the elevator trim tab by utilizing the vertically mounted trim control wheel. Forward rotation of the trim wheel will trim nose-down; conversely, aft rotation will trim nose-up.

INSTRUMENT PANEL

The instrument panel (see figure 7-2) is designed around the basic "T" configuration. The gyros are located immediately in front of the pilot, and

arranged vertically over the control column. The airspeed indicator and altimeter are located to the left and right of the gyros, respectively. The remainder of the flight instruments are located around the basic "T" Engine instruments, fuel quantity indicators, an ammeter, and a low-voltage warning light are near the left edge of the panel. Avionics equipment is stacked approximately on the centerline of the panel, with the right side of the panel containing space for additional instruments and avionics equipment. A switch and control panel at the lower edge of the instrument panel contains the fuel shutoff valve control, primer, master and ignition switches, auxiliary fuel pump switch, circuit breakers, avionics power switch, and electrical switches on the left side, with the engine controls, light intensity controls, and static pressure alternate source valve in the center. The right side of the switch and control panel contains the wing flap switch lever and position indicator, cabin heat and air controls, cigar lighter, and map compartment. A control pedestal, installed below the switch and control panel, contains the elevator trim control wheel and indicator, microphone bracket, cowl flap control lever, and rudder trim control lever. A fuel selector valve handle is located at the base of the pedestal. A parking brake handle is mounted below the switch and control panel in front of the pilot.

For details concerning the instruments, switches, circuit breakers, and controls on this panel, refer in this section to the description of the systems to which these items are related.

GROUND CONTROL

Effective ground control while taxiing is accomplished through nose wheel steering by using the rudder pedals; left rudder pedal to steer left and right rudder pedal to steer right. When a rudder pedal is depressed, a spring-loaded steering bungee (which is connected to the nose gear and to the rudder bars) will turn the nose wheel through an arc of approximately 10° each side of center. By applying either left or right brake, the degree of turn may be increased up to 30° each side of center.

Moving the airplane by hand is most easily accomplished by attaching a tow bar to the nose gear strut. If a tow bar is not available, or pushing is required, use the wing struts as push points. Do not use the vertical or horizontal surfaces to move the airplane. If the airplane is to be towed by vehicle, never turn the nose wheel more than 30° either side of center or structural damage to the nose gear could result.

The minimum turning radius of the airplane, using differential braking and nose wheel steering during taxi, is approximately 27 feet 5 and 1/2 inches. To obtain a minimum radius turn during ground handling, the airplane may be rotated around either main landing gear by pressing down

on a tailcone bulkhead just forward of the horizontal stabilizer to raise the nose wheel off the ground.

WING FLAP SYSTEM

The single-slot type wing flaps (see figure 7-3), are extended or retracted by positioning the wing flap switch lever on the right side of the switch and control panel to the desired flap deflection position. The switch lever is moved up or down in a slotted panel that provides mechanical stops at the 10° and 20° positions. For flap settings greater than 10°, move the switch lever to the right to clear the stop and position it as desired. A scale and pointer on the left side of the switch lever indicates flap travel in degrees. The wing flap system circuit is protected by a 10-amp circuit breaker, labeled FLAP, on the left side of the switch and control panel.

LANDING GEAR SYSTEM

The landing gear is of the tricycle type with a steerable nose wheel, two main wheels, and wheel fairings. Shock absorption is provided by the tubular spring-steel main landing gear struts and the air/oil nose gear

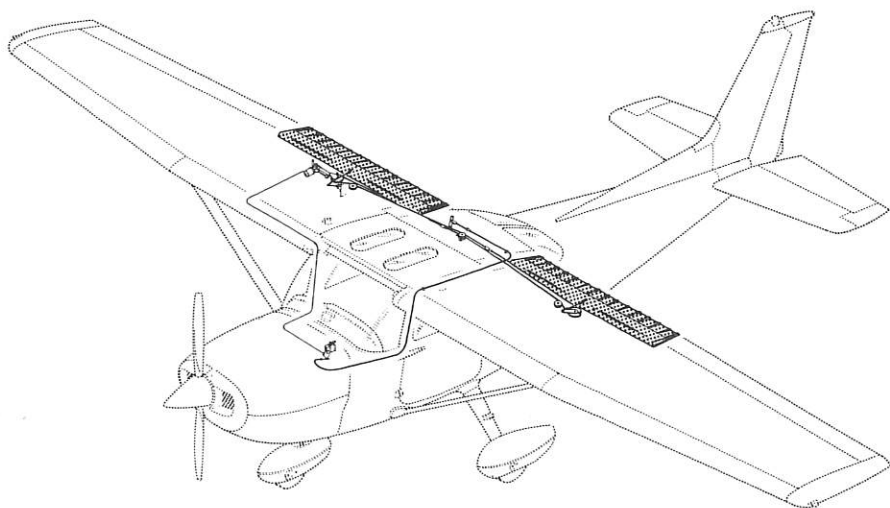

Figure 7-3. Wing Flap System

shock strut. Each main gear wheel is equipped with a hydraulically actuated single disc brake on the inboard side of each wheel, and an aerodynamic fairing over each brake.

BAGGAGE COMPARTMENT

The baggage compartment consists of two areas, one extending from behind the rear passengers' seat to the aft cabin bulkhead, and an additional area aft of the bulkhead. Access to both baggage areas is gained through a lockable baggage door on the left side of the airplane, or from within the airplane cabin. A baggage net with eight tie-down straps is provided for securing baggage and is attached by tying the straps to tie-down rings provided in the airplane. When loading the airplane, children should not be placed or permitted in the baggage compartment, unless a child's seat is installed, and any material that might be hazardous to the airplane or occupants should not be placed anywhere in the airplane. For baggage area and door dimensions, refer to Section 6.

SEATS

The seating arrangement consists of two individually adjustable four-way or six-way seats for the pilot and front seat passenger and a solid back or split-backed fixed seat for rear seat passengers. A child's seat (if installed) is located at the aft cabin bulkhead behind the rear seat.

The four-way seats may be moved forward or aft, and the angle of the seat backs is infinitely adjustable. To position the seat, lift the tubular handle below the center of the seat frame, slide the seat into position, release the handle and check that the seat is locked in place. The seat back angle is controlled by a cylinder lock release button which is spring-loaded to the locked position. The release button is located on the right side, below the forward corner of the seat cushion. To adjust the angle of the seat back, push up on the release button, position the seat back to the desired angle and release the button. When the seat is not occupied, the seat back will automatically fold forward whenever the release button is pushed up.

The six-way seats may be moved forward or aft, and are infinitely adjustable for height and seat back angle. To position the seat, lift the tubular handle under the center of the seat bottom, slide the seat into position, release the handle, and check that the seat is locked in place. Raise or lower the seat by rotating the large crank under the inboard corner of either seat. The seat back is adjusted by rotating the small crank under the outboard corner of either seat. The seat bottom angle will change as the

seat back angle changes, providing proper support. The seat backs will also fold full forward.

The rear passengers' seat consists of a fixed one-piece seat bottom with either one-piece (adjustable to the vertical position or either of two reclining positions) or two-piece (individually, infinitely adjustable) seat backs. The one-piece back is adjusted by a lever located below the center of the seat frame. Two-piece seat backs are adjusted by cylinder lock release buttons recessed into skirts located below the seat frame at the outboard ends of the seat. To adjust the one-piece seat back, raise the lever, position the seat back to the desired angle, release the lever and check that the back is locked in place. To adjust a two-piece seat back, push up on the cylinder lock release button (which is spring-loaded to the locked position), recline the seat back to the desired position, and release the button. When the seats are not occupied, either type of seat back will automatically fold forward whenever the lever is raised or the cylinder lock release button is pushed up.

A child's seat may be installed behind the rear passengers' seat in the forward baggage compartment, and is held in place by two brackets mounted on the floorboard. When not occupied, the seat may be stowed by rotating the seat bottom up and aft until it contacts the aft cabin bulkhead.

Headrests are available for any of the seat configurations except the child's seat. To adjust the headrest, apply enough pressure to it to raise or lower it to the desired level. The headrest may be removed at anytime by raising it until it disengages from the top of the seat back.

SEAT BELTS AND SHOULDER HARNESSSES

All seat positions are equipped with seat belts (see figure 7-4). The pilot's and front passenger's seats are also equipped with separate shoulder harnesses; shoulder harnesses are available for the rear seat positions. Integrated seat belt/shoulder harnesses with inertia reels can be furnished for the pilot's and front passenger's seat positions, if desired.

SEAT BELTS

The seat belts at all seat positions are attached to fittings on the floorboard. The buckle half of the seat belt is inboard of each seat and has a fixed length; the link half of the belt is outboard and is the adjustable part of the belt.

To use the seat belts for the front seats, position the seat as desired, and then lengthen the adjustable half of the belt as needed. Insert and lock the

STANDARD SHOULDER
HARNESS

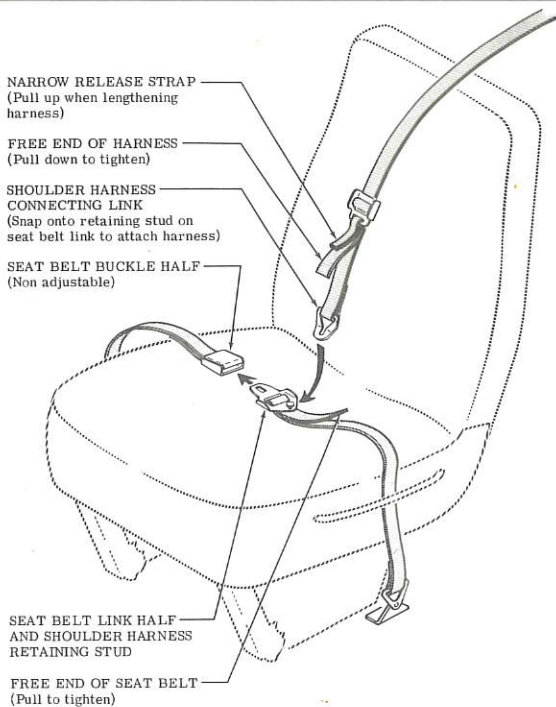

(PILOT'S SEAT SHOWN)

SEAT BELT/SHOULDER
HARNESS WITH INERTIA
REEL

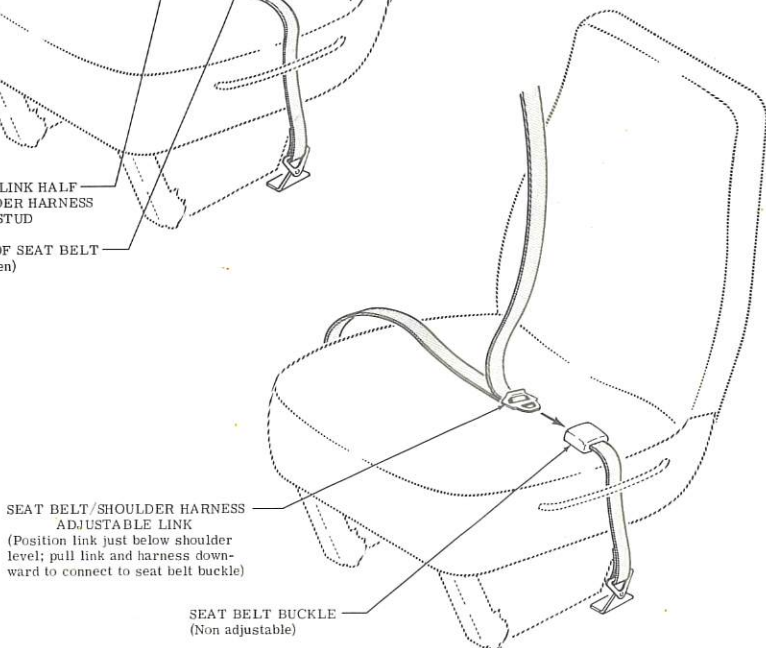

Figure 7-4. Seat Belts and Shoulder Harnesses

belt link into the buckle. Tighten the belt to a snug fit by pulling the free end of the belt. Seat belts for the rear seat, and the child's seat (if installed), are used in the same manner as the belts for the front seats. To release the seat belts, grasp the top of the buckle opposite the link and pull upward.

SHOULDER HARNESSSES

Each front seat shoulder harness is attached to a rear doorpost above the window line and is stowed behind a stowage sheath above the cabin door. To stow the harness, fold it and place it behind the sheath. When rear seat shoulder harnesses are furnished, they are attached adjacent to the lower corners of the rear window. Each rear seat harness is stowed behind a stowage sheath above an aft side window. No harness is available for the child's seat.

To use a front or rear seat shoulder harness, fasten and adjust the seat belt first. Lengthen the harness as required by pulling on the connecting link on the end of the harness and the narrow release strap. Snap the connecting link firmly onto the retaining stud on the seat belt link half. Then adjust to length. A properly adjusted harness will permit the occupant to lean forward enough to sit completely erect, but prevent excessive forward movement and contact with objects during sudden deceleration. Also, the pilot will want the freedom to reach all controls easily.

Removing the shoulder harness is accomplished by pulling upward on the narrow release strap, and removing the harness connecting link from the stud on the seat belt link. In an emergency, the shoulder harness may be removed by releasing the seat belt first and allowing the harness, still attached to the link half of the seat belt, to drop to the side of the seat.

INTEGRATED SEAT BELT/SHOULDER HARNESSSES WITH INERTIA REELS

Integrated seat belt/shoulder harnesses with inertia reels are available for the pilot and front seat passenger. The seat belt/shoulder harnesses extend from inertia reels located in the cabin ceiling to attach points inboard of the two front seats. A separate seat belt half and buckle is located outboard of the seats. Inertia reels allow complete freedom of body movement. However, in the event of a sudden deceleration, they will lock automatically to protect the occupants.

NOTE

The inertia reels are located for maximum shoulder harness comfort and safe retention of the seat occupants. This location requires that the shoulder harnesses cross near the top so that the right hand inertia reel serves the pilot

and the left hand reel serves the front passenger. When fastening the harness, check to ensure the proper harness is being used.

To use the seat belt/shoulder harness, position the adjustable metal link on the harness just below shoulder level, pull the link and harness downward, and insert the link into the seat belt buckle. Adjust belt tension across the lap by pulling upward on the shoulder harness. Removal is accomplished by releasing the seat belt buckle, which will allow the inertia reel to pull the harness inboard of the seat.

ENTRANCE DOORS AND CABIN WINDOWS

Entry to, and exit from the airplane is accomplished through either of two entry doors, one on each side of the cabin at the front seat positions (refer to Section 6 for cabin and cabin door dimensions). The doors incorporate a recessed exterior door handle, a conventional interior door handle, a key-operated door lock (left door only), a door stop mechanism, and an openable window in the left door. An openable right door window is also available.

To open the doors from outside the airplane, utilize the recessed door handle near the aft edge of either door by grasping the forward edge of the handle and pulling outboard. To close or open the doors from inside the airplane, use the combination door handle and arm rest. The inside door handle has three positions and a placard at its base which reads OPEN, CLOSE, and LOCK. The handle is spring-loaded to the CLOSE (up) position. When the door has been pulled shut and latched, lock it by rotating the door handle forward to the LOCK position (flush with the arm rest). When the handle is rotated to the LOCK position, an over-center action will hold it in that position.

NOTE

Accidental opening of a cabin door in flight due to improper closing does not constitute a need to land the airplane. The best procedure is to set up the airplane in a trimmed condition at approximately 75 KIAS, momentarily shove the door outward slightly, and forcefully close and lock the door.

Exit from the airplane is accomplished by rotating the door handle from the LOCK position, past the CLOSE position, aft to the OPEN position and pushing the door open. To lock the airplane, lock the right cabin door with the inside handle, close the left cabin door, and using the ignition key, lock the door.

The left cabin door is equipped with an openable window which is held in the closed position by a detent equipped latch on the lower edge of the window frame. To open the window, rotate the latch upward. The window is equipped with a spring-loaded retaining arm which will help rotate the window outward, and hold it there. An openable window is also available for the right door, and functions in the same manner as the left window. If required, either window may be opened at any speed up to 163 KIAS. The cabin top windows (if installed), rear side windows, and rear windows are of the fixed type and cannot be opened.

CONTROL LOCKS

A control lock is provided to lock the aileron and elevator control surfaces to prevent damage to these systems by wind buffeting while the airplane is parked. The lock consists of a shaped steel rod with a red metal flag attached to it. The flag is labeled CONTROL LOCK, REMOVE BEFORE STARTING ENGINE. To install the control lock, align the hole in the top of the pilot's control wheel shaft with the hole in the top of the shaft collar on the instrument panel and insert the rod into the aligned holes. Installation of the lock will secure the ailerons in a neutral position and the elevators in a slightly trailing edge down position. Proper installation of the lock will place the red flag over the ignition switch. In areas where high or gusty winds occur, a control surface lock should be installed over the vertical stabilizer and rudder. The control lock and any other type of locking device should be removed prior to starting the engine.

ENGINE

The airplane is powered by a horizontally-opposed, six-cylinder, overhead-valve, air-cooled, fuel-injected engine with a wet sump oil system. The engine is a Continental Model IO-360-KB and is rated at 195 horsepower at 2600 RPM. Major accessories include a propeller governor on the front of the engine and dual magnetos, starter, gear-driven alternator, vacuum pump and full flow oil filter on the rear of the engine.

ENGINE CONTROLS

Engine manifold pressure is controlled by a throttle located on the switch and control panel. The throttle operates in a conventional manner; in the full forward position, the throttle is open, and in the full aft position, it is closed. A friction lock, which is a round knurled disk, is located at the base of the throttle and is operated by rotating the lock clockwise to increase friction or counterclockwise to decrease it.

The mixture control, mounted above the right corner of the control pedestal, is a red knob with raised points around the circumference and is equipped with a lock button in the end of the knob. The rich position is full forward, and full aft is the idle-out-off position. For small adjustments, the control may be moved forward by rotating the knob clockwise, and aft by rotating the knob counterclockwise. For rapid or large adjustments, the knob may be moved forward or aft by depressing the lock button in the end of the control, and then positioning the control as desired.

ENGINE INSTRUMENTS

Engine operation is monitored by the following instruments: oil pressure gage, oil temperature gage, cylinder head temperature gage, tachometer, and manifold pressure/fuel flow indicator. An economy mixture (EGT) indicator is also available.

The oil pressure gage, located on the left side of the instrument panel, is operated by oil pressure. A direct pressure oil line from the engine delivers oil at engine operating pressure to the oil pressure gage. Gage markings indicate that minimum idling pressure is 10 PSI (red line), the normal operating range is 30 to 60 PSI (green arc), and maximum pressure is 100 PSI (red line).

Oil temperature is indicated by a gage on the left side of the instrument panel. The gage is operated by an electrical-resistance type temperature sensor which receives power from the airplane electrical system. Oil temperature limitations are the normal operating range (green arc) which is 100°F (38°C) to 240°F (116°C), and the maximum (red line) which is 240°F (116°C).

The cylinder head temperature gage, located on the left side of the instrument panel, is operated by an electrical-resistance type temperature sensor on the engine which receives power from the airplane electrical system. Temperature limitations are the normal operating range (green arc) which is 200°F (93°C) to 460°F (238°C), and the maximum (red line) which is 460°F (238°C).

The engine-driven mechanical tachometer is located near the lower portion of the instrument panel to the right of the pilot's control wheel. The instrument is calibrated in increments of 100 RPM and indicates both engine and propeller speed. An hour meter below the center of the tachometer dial records elapsed engine time in hours and tenths. Instrument markings include a normal operating range (green arc) of 2200 to 2600 RPM, and a maximum (red line) of 2600 RPM.

The manifold pressure gage is the left half of a dual-indicating instrument and is located near the lower portion of the instrument panel to

the left of the pilot's control wheel. The gage is direct reading and indicates induction air manifold pressure in inches of mercury. It has a normal operating range (green arc) of 15 to 25 inches of mercury.

The fuel flow indicator is the right half of a dual-indicating instrument and is located to the left of the pilot's control wheel. The indicator is a fuel pressure gage calibrated to indicate the approximate gallons per hour of fuel being metered to the engine. The normal operating range (green arc) is from 4.5 to 11.5 gallons per hour, the minimum (red line) is 3 PSI, and the maximum (red line) is 17 gallons per hour (17 PSI).

An economy mixture (EGT) indicator is available for the airplane and is located on the right side of the instrument panel. A thermocouple probe in the left exhaust collector measures exhaust gas temperature and transmits it to the indicator. The indicator serves as a visual aid to the pilot in adjusting cruise mixture. Exhaust gas temperature varies with fuel-to-air ratio, power, and RPM. However, the difference between the peak EGT and the EGT at the cruise mixture setting is essentially constant and this provides a useful leaning aid. The indicator is equipped with a manually positioned reference pointer.

NEW ENGINE BREAK-IN AND OPERATION

The engine underwent a run-in at the factory and is ready for the full range of use. It is, however, suggested that cruising be accomplished at 65% to 80% power until a total of 50 hours has accumulated or oil consumption has stabilized. This will ensure proper seating of the rings.

The airplane is delivered from the factory with corrosion preventive oil in the engine. If, during the first 25 hours, oil must be added, use only aviation grade straight mineral oil conforming to Specification No. MIL-L-6082.

ENGINE OIL SYSTEM

Oil for engine lubrication and propeller governor operation is supplied from a sump on the bottom of the engine. The capacity of the engine sump is eight quarts (one additional quart is contained in the engine oil filter). Oil is drawn from the sump through a filter screen on the end of a pick-up tube to the engine-driven oil pump. Oil from the pump passes through the full flow oil filter, a pressure relief valve, and a thermostatically controlled oil cooler. Oil from the cooler is then circulated to the oil galleries and propeller governor. The engine parts are then lubricated by oil from the galleries. After lubricating the engine, the oil returns to the sump by gravity. The oil filter adapter is equipped with a bypass valve which will cause lubricating oil to bypass the filter in the event the filter becomes plugged, or the oil temperature is extremely cold.

An oil filler cap and oil dipstick are located at the rear of the engine on the left side. The filler cap and dipstick are accessible through an access door in the engine cowling. The engine should not be operated on less than six quarts of oil. To minimize loss of oil through the breather, fill to seven quarts for normal flights of less than three hours. For extended flight, fill to eight quarts (dipstick indication only). For engine oil grade and specifications, refer to Section 8 of this handbook.

An oil quick-drain valve is available to replace the drain plug in the oil sump drain port and provides quicker, cleaner draining of the engine oil. To drain the oil with this valve, slip a hose over the end of the valve and push upward on the end of the valve until it snaps into the open position. Spring clips will hold the valve open. After draining, use a suitable tool to snap the valve into the extended (closed) position and remove the drain hose.

IGNITION-STARTER SYSTEM

Engine ignition is provided by two engine-driven magnetos, and two spark plugs in each cylinder. The right magneto fires the lower left and upper right spark plugs, and the left magneto fires the lower right and upper left spark plugs. Normal operation is conducted with both magnetos due to the more complete burning of the fuel-air mixture with dual ignition.

Ignition and starter operation is controlled by a rotary type switch located on the left switch and control panel. The switch is labeled clockwise, OFF, R, L, BOTH, and START. The engine should be operated on both magnetos (BOTH position) except for magneto checks. The R and L positions are for checking purposes and emergency use only. When the switch is rotated to the spring-loaded START position, (with the master switch in the ON position), the starter contactor is energized and the starter will crank the engine. When the switch is released, it will automatically return to the BOTH position.

AIR INDUCTION SYSTEM

Ram air entering the openings in the front of the engine cowling serves as induction air for the engine. The air is drawn through a cylindrical filter on top of the engine and into the induction airbox. The induction airbox contains an alternate air door which is spring-loaded to the closed position. If the induction air filter becomes blocked, suction created by the engine will open the alternate air door and draw unfiltered air from inside the cowling. An open alternate air door will result in negligible variations in manifold pressure and power. After passing through the airbox, induction air enters the fuel/air control unit, mounted to the induction

airbox and is then delivered to the engine cylinders through the induction manifold.

EXHAUST SYSTEM

Exhaust gas from each cylinder passes through riser assemblies to a muffler and tailpipe. The muffler is constructed with a shroud around the outside which forms a heating chamber for cabin heater air.

FUEL INJECTION AND MANUAL PRIMING SYSTEM

The engine is equipped with a fuel injection system. The system is comprised of an engine-driven fuel pump, fuel/air control unit, fuel distributor manifold, fuel flow indicator and air-bleed type injector nozzles.

Fuel is delivered by the engine-driven fuel pump to the fuel/air control unit on the engine. The fuel/air control unit correctly proportions the fuel flow to the induction air flow. After passing through the control unit, induction air is delivered to the cylinders through intake manifold tubes, and metered fuel is delivered to a fuel distributor manifold. The fuel manifold, through spring tension on a diaphragm and valve, evenly distributes the fuel to an air-bleed type injector nozzle in the intake valve chamber of each cylinder. A pressure line is also attached to the fuel manifold, and is connected to the fuel flow indicator on the instrument panel.

The engine is equipped with a manual priming system for starting in extremely cold weather. The primer is a small pump labeled PRIMER, and is located on the left switch and control panel below the fuel shutoff valve knob. The primer draws fuel from the fuel strainer when the plunger is pulled out, and injects it into the intake manifolds when the plunger is pushed in. The plunger is equipped with a lock, and after being pushed full in, must be rotated either left or right until the knob cannot be pulled out.

COOLING SYSTEM

Ram air for engine cooling enters through two intake openings in the front of the engine cowling. The cooling air is directed around the cylinders and other areas of the engine by baffling, and is then exhausted through a cowl flap on the lower aft edge of the cowling. The cowl flap is mechanically operated from the cabin by means of a cowl flap lever on the right side of the control pedestal. The pedestal is labeled COWL FLAP, OPEN, CLOSED. During takeoff and high power operation, the cowl flap lever should be placed in the OPEN position for maximum cooling. This is accomplished by moving the lever to the left to clear a detent, then moving the lever up to the OPEN position. Anytime the lever is repositioned, it

must first be moved to the left. While in cruise flight, the cowl flap should be adjusted to keep the cylinder head temperature at approximately two-thirds of the normal operating range (green arc). During extended let-downs, it may be necessary to completely close the cowl flap by pushing the cowl flap lever down to the CLOSED position.

A winterization kit is available for the airplane. Details of this kit are presented in Section 9, Supplements.

PROPELLER

The airplane has an all-metal, two-bladed, constant-speed, governor-regulated propeller. A setting introduced into the governor with the propeller control establishes the propeller speed, and thus the engine speed to be maintained. The governor then controls flow of engine oil, boosted to high pressure by the governing pump, to or from a piston in the propeller hub. Oil pressure acting on the piston twists the blades toward high pitch (low RPM). When oil pressure to the piston in the propeller hub is relieved, centrifugal force, assisted by an internal spring, twists the blades toward low pitch (high RPM).

A control knob on the lower center portion of the instrument panel is used to set the propeller and control engine RPM as desired for various flight conditions. The knob is labeled PROP RPM, PUSH INCR. When the control knob is pushed in, blade pitch will decrease, giving a higher RPM. When the control knob is pulled out, the blade pitch increases, thereby decreasing RPM. The propeller control knob is equipped with a vernier feature which allows slow or fine RPM adjustments by rotating the knob clockwise to increase RPM, and counterclockwise to decrease it. To make rapid or large adjustments, depress the button on the end of the control knob and reposition the control as desired.

FUEL SYSTEM

The airplane may be equipped with either a standard or long range fuel system (see figure 7-5). The standard system has two vented fuel tanks (one in each wing); the long range fuel system has two vented integral fuel tanks (one in each wing). Both systems include a fuel selector valve, fuel reservoir tank, fuel shutoff valve, auxiliary fuel pump, fuel strainer, manual primer, engine-driven fuel pump and mixture unit, fuel/air control unit, fuel manifold, and fuel injection nozzles. Refer to figure 7-6 for fuel quantity data for both systems.

Fuel flows by gravity from the two wing tanks to a three-position selector valve, labeled BOTH, RIGHT, and LEFT. With the selector valve in either the BOTH, RIGHT, or LEFT position, fuel flows through a fuel reservoir tank, fuel shutoff valve, a bypass in the auxiliary fuel pump (when it is not in operation), and the fuel strainer to the engine-driven fuel pump. The engine-driven fuel pump delivers the fuel to the fuel/air control unit where it is metered and routed to a fuel manifold which distributes it to each cylinder. Vapor and excess fuel from the engine-driven fuel pump and mixture unit are returned to the fuel reservoir tank by a check valve equipped vapor return line, and from the reservoir tank to the wing tanks.

Fuel system venting is essential to system operation. Blockage of the system will result in decreasing fuel flow and eventual engine stoppage. Venting is accomplished by an interconnecting line from the right fuel tank to the left tank. The left fuel tank is vented overboard through a vent line, equipped with a check valve, which protrudes from the bottom surface of the left wing near the wing strut. The right fuel tank filler cap is also vented.

Fuel quantity is measured by two float-type fuel quantity transmitters (one in each fuel tank) and indicated by two electrically-operated fuel quantity indicators on the left side of the instrument panel. The fuel quantity indicators are calibrated in gallons (lower scale) and pounds (upper scale). An empty tank is indicated by a red line and the letter E. When an indicator shows an empty tank, approximately 1.5 gallons remain in a standard tank (approximately 1 gallon remains in a long range tank) as unusable fuel. The indicators cannot be relied upon for accurate readings during skids, slips, or unusual flight attitudes. If both indicator pointers should rapidly move to a zero reading, check the cylinder head temperature and oil temperature gages for operation. If these gages show no indication, an electrical malfunction has occurred.

The fuel selector valve should be in the BOTH position for takeoff, climb, landing, and maneuvers that involve prolonged slips or skids.

NOTE

When the fuel selector valve handle is in the BOTH position in cruising flight, unequal fuel flow from each tank may occur if the wings are not maintained exactly level. Resulting wing heaviness can be alleviated gradually by turning the selector valve handle to the tank in the "heavy" wing.

If the airplane is equipped with the long range fuel system, it may be serviced to a reduced fuel capacity to permit heavier cabin loadings by filling each integral fuel tank to the bottom of the standpipe (scupper)

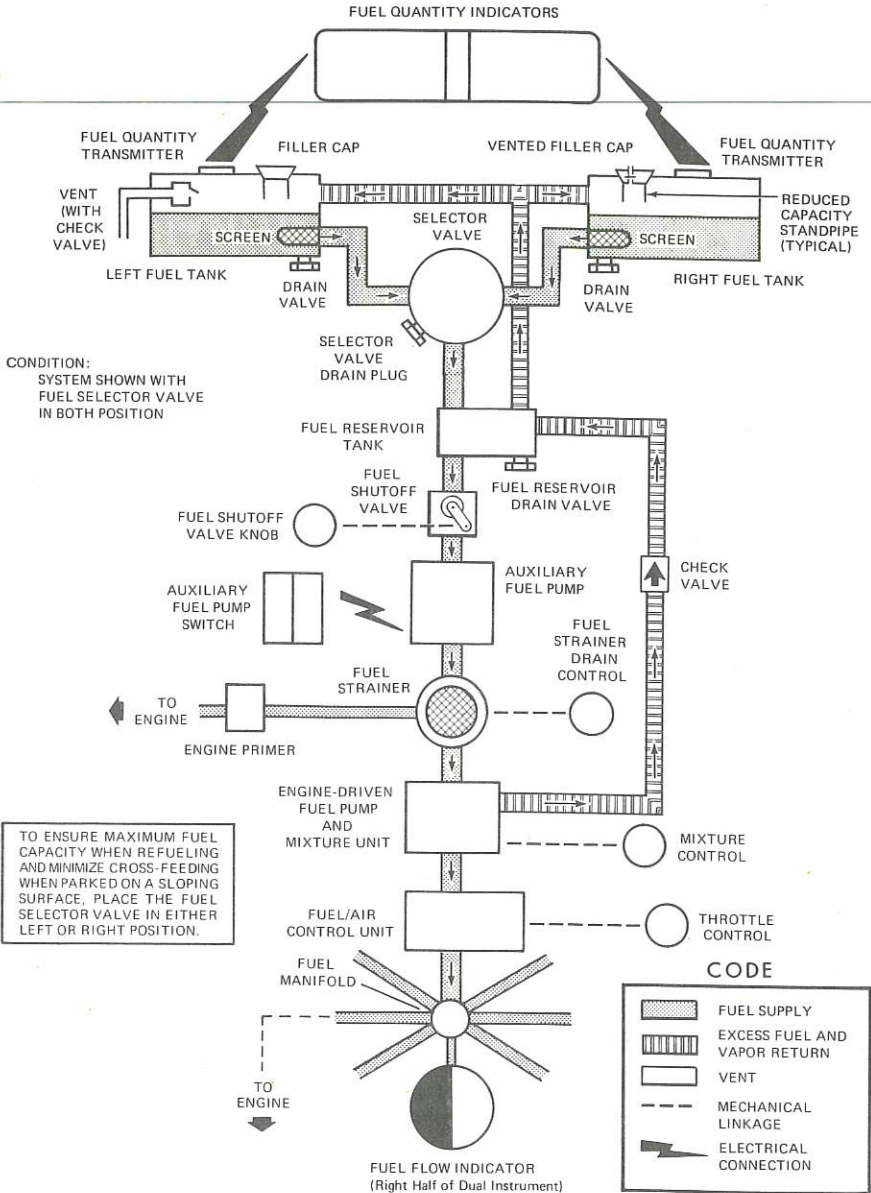

Figure 7-5. Fuel System (Standard and Long Range)

FUEL QUANTITY DATA (U. S. GALLONS)			
TANKS	TOTAL USABLE FUEL ALL FLIGHT CONDITIONS	TOTAL UNUSABLE FUEL	TOTAL FUEL VOLUME
STANDARD (26 Gal. Each)	49	3	52
LONG RANGE (34 Gal. Each)	66	2	68
REDUCED FUEL (26 Gal. Each)	50	2	52

Figure 7-6. Fuel Quantity Data

located in the filler collar. Each fuel tank contains 26 gallons (25 gallons usable in all flight conditions) when filled to this level.

NOTE

It is not practical to measure the time required to consume all of the fuel in one tank, and, after switching to the opposite tank, expect an equal duration from the remaining fuel. The airspace in both fuel tanks is interconnected by a vent line and, therefore, some sloshing of fuel between tanks can be expected when the tanks are nearly full and the wings are not level.

The auxiliary fuel pump switch, labeled AUX FUEL PUMP, is located on the left side of the switch and control panel and is a red and yellow split-rocker switch. The red left half, labeled HIGH, is spring-loaded in the off (down) position and the yellow right half is labeled LOW. When the red half is placed in the HIGH position, an interlock within the switch will automatically trip the yellow half of the switch to the LOW position. When the red half of the switch is released, the yellow half will remain in the LOW position until manually returned to the off position. The HIGH position is used primarily for engine starting and extreme vapor purging, and is also used in the event of an engine-driven fuel pump failure during takeoff or high power operations.

NOTE

If the auxiliary fuel pump switch is accidentally placed in the HIGH or LOW position with the master switch on, mixture rich, and the engine stopped, the intake manifolds will be flooded.

The LOW position of the switch is used for minor vapor purging and continued engine operation in the event of an engine-driven fuel pump failure. When the switch is placed in the LOW position, the auxiliary fuel pump will operate at one of two flow rates depending on the position of the throttle. With the throttle in a cruise flight position, the pump will provide a high enough fuel flow to maintain flight in the event of an engine-driven fuel pump failure. As the throttle is moved toward the closed position (during letdown, landing, or taxiing), fuel flow provided by the pump is automatically reduced by a throttle-actuated switch, preventing an excessively rich mixture during periods of reduced engine power.

NOTE

If the engine-driven fuel pump is functioning and the auxiliary fuel pump switch is placed in the LOW position, an excessively rich fuel/air ratio is produced unless the mixture is leaned. Therefore, this switch should be turned off during takeoff.

If it is desired to completely exhaust a fuel tank quantity in flight, the auxiliary fuel pump will be needed to assist in restarting the engine when fuel exhaustion occurs. Therefore, it is recommended that proper operation of the auxiliary fuel pump be verified prior to running a fuel tank dry by placing the auxiliary fuel pump switch in the HIGH position momentarily and checking for a slight rise in fuel flow indication.

To ensure a prompt engine restart in flight after running a fuel tank dry, immediately switch to the tank containing fuel at the first indication of fuel pressure fluctuation and/or power loss. Then place the auxiliary fuel pump switch in the HIGH position momentarily (3 to 5 seconds) with the throttle at least 1/2 open. Excessive use of the HIGH position at high altitude and full rich mixture can cause flooding of the engine as indicated by a short (1 to 2 seconds) period of power followed by a loss of power. This can later be detected by a fuel flow indication accompanied by a lack of power. If flooding does occur, turn off the auxiliary fuel pump switch, and normal propeller windmilling should start the engine in 1 to 2 seconds.

If the propeller should stop (possible at very low airspeeds) before the tank containing fuel is selected, place the auxiliary fuel pump switch in the HIGH position and advance the throttle promptly until the fuel flow indicator registers approximately 1/2 way into the green arc for 1 to 2 seconds duration. Then retard the throttle, turn off the auxiliary fuel pump switch, and use the starter to turn the engine over until a start is obtained.

The fuel system is equipped with drain valves to provide a means for the examination of fuel in the system for contamination and grade. The system should be examined before the first flight of every day and after

each refueling, by using the sampler cup provided to drain fuel from the wing tank sumps and fuel reservoir tank, and by utilizing the fuel strainer drain under an access door on the left side of the engine cowling. The fuel tanks should be filled after each flight to prevent condensation.

BRAKE SYSTEM

The airplane has a single-disc, hydraulically-actuated brake on each main landing gear wheel. Each brake is connected, by a hydraulic line, to a master cylinder attached to each of the pilot's rudder pedals. The brakes are operated by applying pressure to the top of either the left (pilot's) or right (copilot's) set of rudder pedals, which are interconnected. When the airplane is parked, both main wheel brakes may be set by utilizing the parking brake which is operated by a handle under the left side of the instrument panel. To apply the parking brake, set the brakes with the rudder pedals, pull the handle aft, and rotate it 90° down.

For maximum brake life, keep the brake system properly maintained, and minimize brake usage during taxi operations and landings.

Some of the symptoms of impending brake failure are: gradual decrease in braking action after brake application, noisy or dragging brakes, soft or spongy pedals, and excessive travel and weak braking action. If any of these symptoms appear, the brake system is in need of immediate attention. If, during taxi or landing roll, braking action decreases, let up on the pedals and then re-apply the brakes with heavy pressure. If the brakes become spongy or pedal travel increases, pumping the pedals should build braking pressure. If one brake becomes weak or fails, use the other brake sparingly while using opposite rudder, as required, to offset the good brake.

ELECTRICAL SYSTEM

The airplane is equipped with a 28-volt, direct-current electrical system (see figure 7-7). The system is powered by a gear-driven, 38-amp alternator and a 24-volt battery (a heavy duty battery is available), located on the aft side of the rear cabin bulkhead. Power is supplied to most general electrical and all avionics circuits through the primary bus bar and the avionics bus bar, which are interconnected by an avionics power switch.

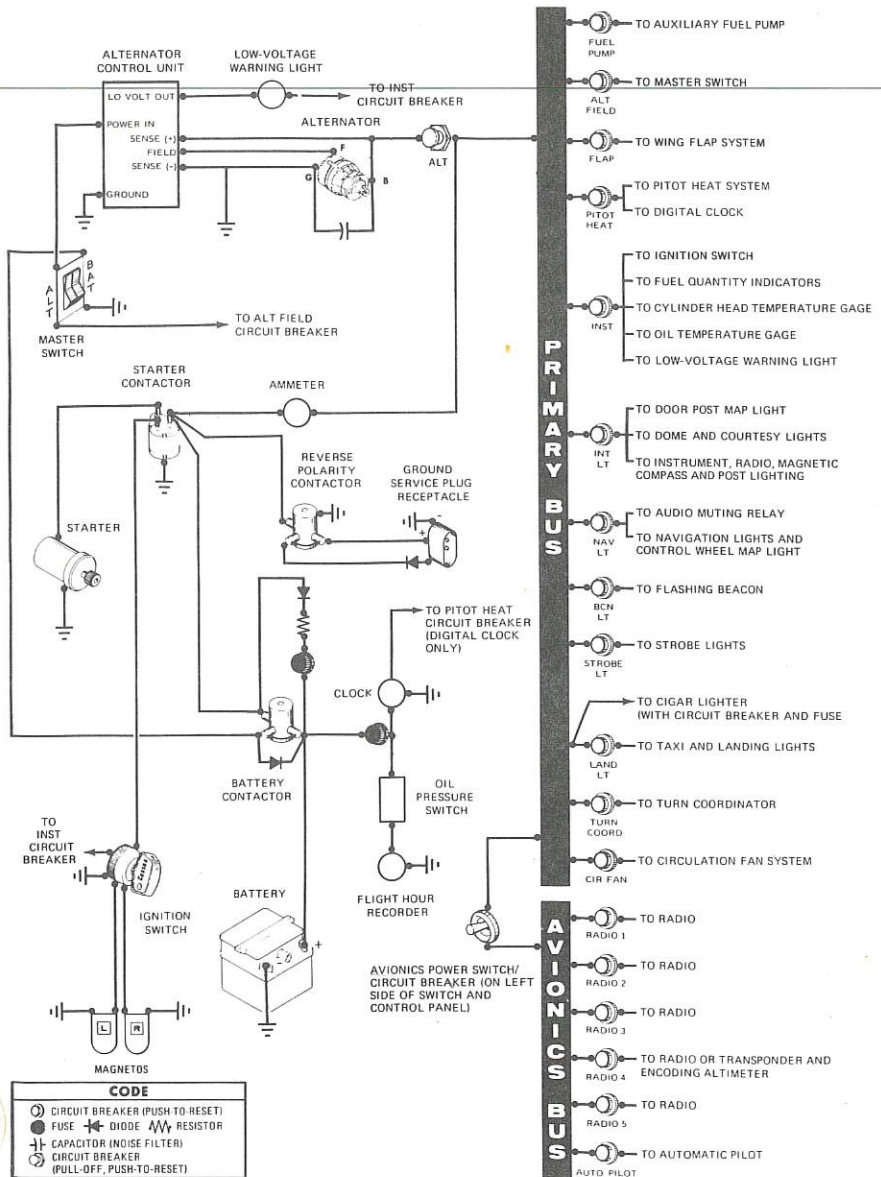

Figure 7-7. Electrical System

The primary bus is on anytime the master switch is turned on, and is not affected by starter or external power usage. Both bus bars are on anytime the master and avionics power switches are turned on.

CAUTION

Prior to turning the master switch on or off, starting the engine, or applying an external power source, the avionics power switch, labeled AVIONICS POWER, should be turned off to prevent any harmful transient voltage from damaging the avionics equipment.

MASTER SWITCH

The master switch is a split-rocker type switch labeled MASTER, and is ON in the up position and off in the down position. The right half of the switch, labeled BAT, controls all electrical power to the airplane. The left half, labeled ALT, controls the alternator.

Normally, both sides of the master switch should be used simultaneously; however, the BAT side of the switch could be turned ON separately to check equipment while on the ground. To check or use avionics equipment or radios while on the ground, the avionics power switch must be turned on. The ALT side of the switch, when placed in the off position, removes the alternator from the electrical system. With this switch in the off position, the entire electrical load is placed on the battery. Continued operation with the alternator switch in the off position will reduce battery power low enough to open the battery contactor, remove power from the alternator field, and prevent alternator restart.

AVIONICS POWER SWITCH

Electrical power from the airplane primary bus to the avionics bus (see figure 7-7) is controlled by a toggle switch/circuit breaker labeled AVIONICS POWER. The switch is located on the left side of the switch and control panel and is ON in the up position and off in the down position. With the switch in the off position, no electrical power will be applied to the avionics equipment, regardless of the position of the master switch or the individual equipment switches. The avionics power switch also functions as a circuit breaker. If an electrical malfunction should occur and cause the circuit breaker to open, electrical power to the avionics equipment will be interrupted and the switch will automatically move to the off position. If this occurs, allow the circuit breaker to cool approximately two minutes before placing the switch in the ON position again. If the circuit breaker opens again, do not reset it. The avionics power switch should be placed in the off position prior to turning the master switch ON or off, starting the engine, or applying an external power source, and may be utilized in place

of the individual avionics equipment switches.

AMMETER

The ammeter, located adjacent to the oil pressure gage, indicates the amount of current, in amperes, from the alternator to the battery or from the battery to the airplane electrical system. When the engine is operating and the master switch is turned on, the ammeter indicates the charging rate applied to the battery. In the event the alternator is not functioning or the electrical load exceeds the output of the alternator, the ammeter indicates the battery discharge rate.

ALTERNATOR CONTROL UNIT AND LOW-VOLTAGE WARNING LIGHT

The airplane is equipped with a combination alternator regulator high-low voltage control unit mounted on the engine side of the firewall and a red warning light, labeled LOW VOLTAGE, on the left side of the instrument panel below the oil temperature gage.

In the event an over-voltage condition occurs, the alternator control unit automatically removes alternator field current which shuts down the alternator. The battery will then supply system current as shown by a discharge rate on the ammeter. Under these conditions, depending on electrical system load, the low-voltage warning light will illuminate when system voltage drops below normal. The alternator control unit may be reset by turning the master switch off and back on again. If the warning light does not illuminate, normal alternator charging has resumed; however, if the light does illuminate again, a malfunction has occurred, and the flight should be terminated as soon as practicable.

NOTE

Illumination of the low-voltage light and ammeter discharge indications may occur during low RPM conditions with an electrical load on the system, such as during a low RPM taxi. Under these conditions, the light will go out at higher RPM. The master switch need not be recycled since an over-voltage condition has not occurred to de-activate the alternator system.

The warning light may be tested by turning on the landing lights and momentarily turning off the ALT portion of the master switch while leaving the BAT portion turned on.

CIRCUIT BREAKERS AND FUSES

Most of the electrical circuits in the airplane are protected by "push-to-reset" type circuit breakers mounted on the left side of the switch and control panel. However, alternator output is protected by a "pull-off" type circuit breaker. In addition to the individual circuit breakers, a toggle switch/circuit breaker, labeled AVIONICS POWER, on the left side of the switch and control panel also protects the avionics systems. The cigar lighter is protected by a manually-reset type circuit breaker on the back of the lighter, and a fuse behind the instrument panel. The control wheel map light (if installed) is protected by the NAV LT circuit breaker and a fuse behind the instrument panel. Electrical circuits which are not protected by circuit breakers are the battery contactor closing (external power) circuit, clock circuit, and flight hour recorder circuit. These circuits are protected by fuses mounted adjacent to the battery.

GROUND SERVICE PLUG RECEPTACLE

A ground service plug receptacle may be installed to permit the use of an external power source for cold weather starting and during lengthy maintenance work on the electrical and electronic equipment. Details of the ground service plug receptacle are presented in Section 9, Supplements.

LIGHTING SYSTEMS

EXTERIOR LIGHTING

Conventional navigation lights are located on the wing tips and top of the rudder. Dual landing/taxi lights are installed in the cowl nose cap. Additional lighting is available and includes a flashing beacon mounted on top of the vertical fin, a strobe light on each wing tip, and a courtesy light recessed into the lower surface of each wing slightly outboard of the cabin doors. Details of the strobe light system are presented in Section 9, Supplements. The courtesy lights are operated by the DOME LIGHTS switch located on the overhead console; push the switch to the right to turn the lights on. The remaining exterior lights are operated by rocker

switches on the left switch and control panel; push the rocker up to the ON position.

The flashing beacon should not be used when flying through clouds or overcast; the flashing light reflected from water droplets or particles in the atmosphere, particularly at night, can produce vertigo and loss of orientation.

INTERIOR LIGHTING

Instrument panel and switch and control panel lighting is provided by flood lighting, integral lighting, and post lighting (if installed). Lighting intensity is controlled by a dual light dimming rheostat equipped with an outer knob labeled PANEL LT, and an inner knob labeled RADIO LT, located below the throttle. A slide-type switch (if installed) on the overhead console, labeled PANEL LIGHTS, is used to select flood lighting in the FLOOD position, post lighting in the POST position, or a combination of post and flood lighting in the BOTH position.

Instrument panel and switch and control panel flood lighting consists of a single red flood light in the forward edge of the overhead console. To use flood lighting, move the slide switch in the overhead console, labeled PANEL LIGHTS, to the FLOOD position and rotate the outer knob on the light dimming rheostat, labeled PANEL LT, clockwise to the desired light intensity.

Post lights (if installed) are mounted at the edge of each instrument and provide direct lighting. To use post lighting, move the slide switch in the overhead console, labeled PANEL LIGHTS, to the POST position and rotate the outer knob on the light dimming rheostat, labeled PANEL LT, clockwise to obtain the desired light intensity. When the PANEL LIGHTS switch is placed in the BOTH position, the flood lights and post lights will operate simultaneously.

The radio equipment, magnetic compass and engine instrument cluster (when post lights are installed) have integral lighting and operate independently of post or flood lighting. The intensity of this lighting is controlled by the inner knob on the light dimming rheostat labeled RADIO LT; rotate the knob clockwise to obtain the desired light intensity. However, for daylight operation, the compass and engine instrument lights may be turned off while still maintaining maximum light intensity for digital readouts in the radio equipment. This is accomplished by rotating the RADIO LT knob full counterclockwise. Check that the flood lights/post lights are turned off for daylight operation by rotating the PANEL LT knob full counterclockwise.

A cabin dome light, in the aft part of the overhead console, is operated by a switch near the light. To turn the light on, move the switch to the right.

A control wheel map light is available and is mounted on the bottom of the pilot's control wheel. The light illuminates the lower portion of the cabin just forward of the pilot and is helpful when checking maps and other flight data during night operations. To operate the light, first turn on the NAV LT switch; then adjust the map light's intensity with the knurled disk type rheostat control located at the bottom of the control wheel.

A doorpost map light is located on the left forward doorpost. It contains both red and white bulbs and may be positioned to illuminate any area desired by the pilot. The light is controlled by a switch, below the light, which is labeled RED, OFF, and WHITE. Placing the switch in the top position will provide a red light. In the bottom position, standard white lighting is provided. In the center position, the map light is turned off. Red light intensity is controlled by the outer knob on the light dimming rheostat labeled PANEL LT.

The most probable cause of a light failure is a burned out bulb; however, in the event any of the lighting systems fail to illuminate when turned on, check the appropriate circuit breaker. If the circuit breaker has opened (white button popped out), and there is no obvious indication of a short circuit (smoke or odor), turn off the light switch of the affected lights, reset the breaker, and turn the switch on again. If the breaker opens again, do not reset it.

CABIN HEATING, VENTILATING AND DEFROSTING SYSTEM

The temperature and volume of airflow into the cabin can be regulated by manipulation of the push-pull CABIN HT and CABIN AIR control knobs (see figure 7-8).

For cabin ventilation, pull the CABIN AIR knob out. To raise the air temperature, pull the CABIN HT knob out approximately 1/4 to 1/2 inch for a small amount of cabin heat. Additional heat is available by pulling the knob out farther; maximum heat is available with the CABIN HT knob pulled out and the CABIN AIR knob pushed full in. When no heat is desired in the cabin, the CABIN HT knob is pushed full in.

Front cabin heat and ventilating air is supplied by outlet holes spaced across a cabin manifold just forward of the pilot's and copilot's feet. Rear cabin heat and air is supplied by two ducts from the manifold, one extending down each side of the cabin to an outlet at the front doorpost at floor level. Windshield defrost air is supplied by two ducts leading from the cabin manifold to outlets near the lower edge of the windshield. Two knobs control sliding valves in either defroster outlet to permit regulation of defroster airflow.

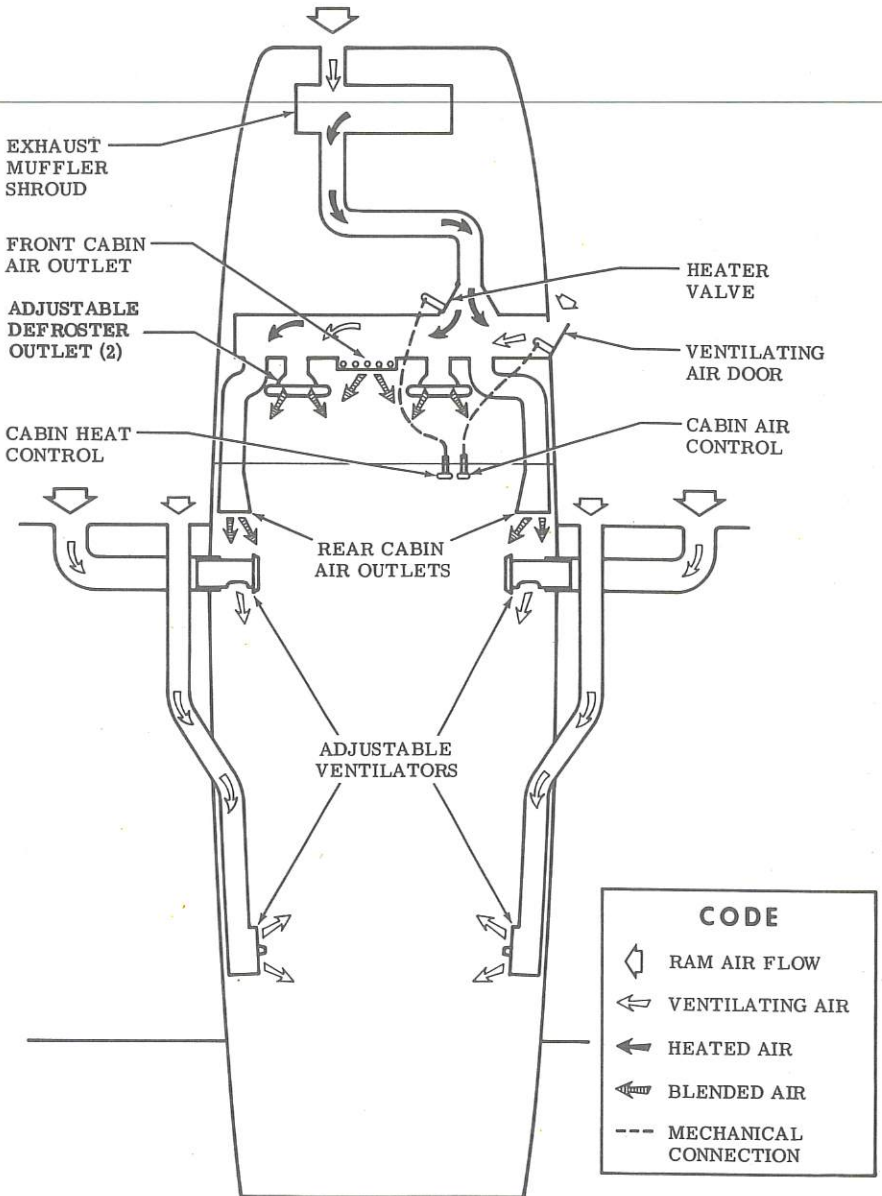

Figure 7-8. Cabin Heating, Ventilating, and Defrosting System

Separate adjustable ventilators supply additional air; one near each upper corner of the windshield supplies air for the pilot and copilot, and two ventilators are available for the rear cabin area to supply air to the rear seat passengers.

PITOT-STATIC SYSTEM AND INSTRUMENTS

The pitot-static system supplies ram air pressure to the airspeed indicator and static pressure to the airspeed indicator, vertical speed indicator and altimeter. The system is composed of either an unheated or heated pitot tube mounted on the lower surface of the left wing, two external static ports on the lower left and right sides of the forward fuselage, and the associated plumbing necessary to connect the instruments to the sources.

The heated pitot system (if installed) consists of a heating element in the pitot tube, a rocker switch labeled PITOT HT, a 5-amp circuit breaker, and associated wiring. The switch and circuit breaker are located on the left side of the switch and control panel. When the pitot heat switch is turned on, the element in the pitot tube is heated electrically to maintain proper operation in possible icing conditions. Pitot heat should be used only as required.

A static pressure alternate source valve may be installed on the switch and control panel below the throttle, and can be used if the external static source is malfunctioning. This valve supplies static pressure from inside the cabin instead of the external static ports.

If erroneous instrument readings are suspected due to water or ice in the pressure line going to the standard external static pressure source, the alternate static source valve should be pulled on.

Pressures within the cabin will vary with heater/vents opened or closed. Refer to Sections 3 and 5 for the effect of varying cabin pressures on airspeed and altimeter readings.

AIRPEED INDICATOR

The airspeed indicator is calibrated in knots and miles per hour. Limitation and range markings (in KIAS) include the white arc (38 to 85 knots), green arc (48 to 129 knots), yellow arc (129 to 163 knots), and a red line (163 knots).

If a true airspeed indicator is installed, it is equipped with a rotatable ring which works in conjunction with the airspeed indicator dial in a

manner similar to the operation of a flight computer. To operate the indicator, first rotate the ring until **pressure altitude** is aligned with outside air temperature in degrees Fahrenheit. Pressure altitude should not be confused with indicated altitude. To obtain pressure altitude, momentarily set the barometric scale on the altimeter to 29.92 and read the pressure altitude on the altimeter. Be sure to return the altimeter barometric scale to the original barometric setting after pressure altitude has been obtained. Having set the ring to correct for altitude and temperature, read the true airspeed shown on the rotatable ring by the indicator pointer. For best accuracy, the indicated airspeed should be corrected to calibrated airspeed by referring to the Airspeed Calibration chart in Section 5. Knowing the calibrated airspeed, read true airspeed on the ring opposite the calibrated airspeed.

VERTICAL SPEED INDICATOR

The vertical speed indicator depicts airplane rate of climb or descent in feet per minute. The pointer is actuated by atmospheric pressure changes resulting from changes of altitude as supplied by the static source.

ALTIMETER

Airplane altitude is depicted by a barometric type altimeter. A knob near the lower left portion of the indicator provides adjustment of the instrument's barometric scale to the current altimeter setting.

VACUUM SYSTEM AND INSTRUMENTS

An engine-driven vacuum system (see figure 7-9) provides the suction necessary to operate the attitude indicator and directional indicator. The system consists of a vacuum pump mounted on the engine, a vacuum relief valve and vacuum system air filter on the aft side of the firewall below the instrument panel, and instruments (including a suction gage) on the left side of the instrument panel.

ATTITUDE INDICATOR

The attitude indicator gives a visual indication of flight attitude. Bank attitude is presented by a pointer at the top of the indicator relative to the bank scale which has index marks at 10°, 20°, 30°, 60°, and 90° either side of the center mark. Pitch and roll attitudes are presented by a miniature airplane superimposed over a symbolic horizon area divided into two sections by a white horizon bar. The upper "blue sky" area and the lower "ground" area have arbitrary pitch reference lines useful for pitch attitude control. A knob at the bottom of the instrument is provided for in-flight

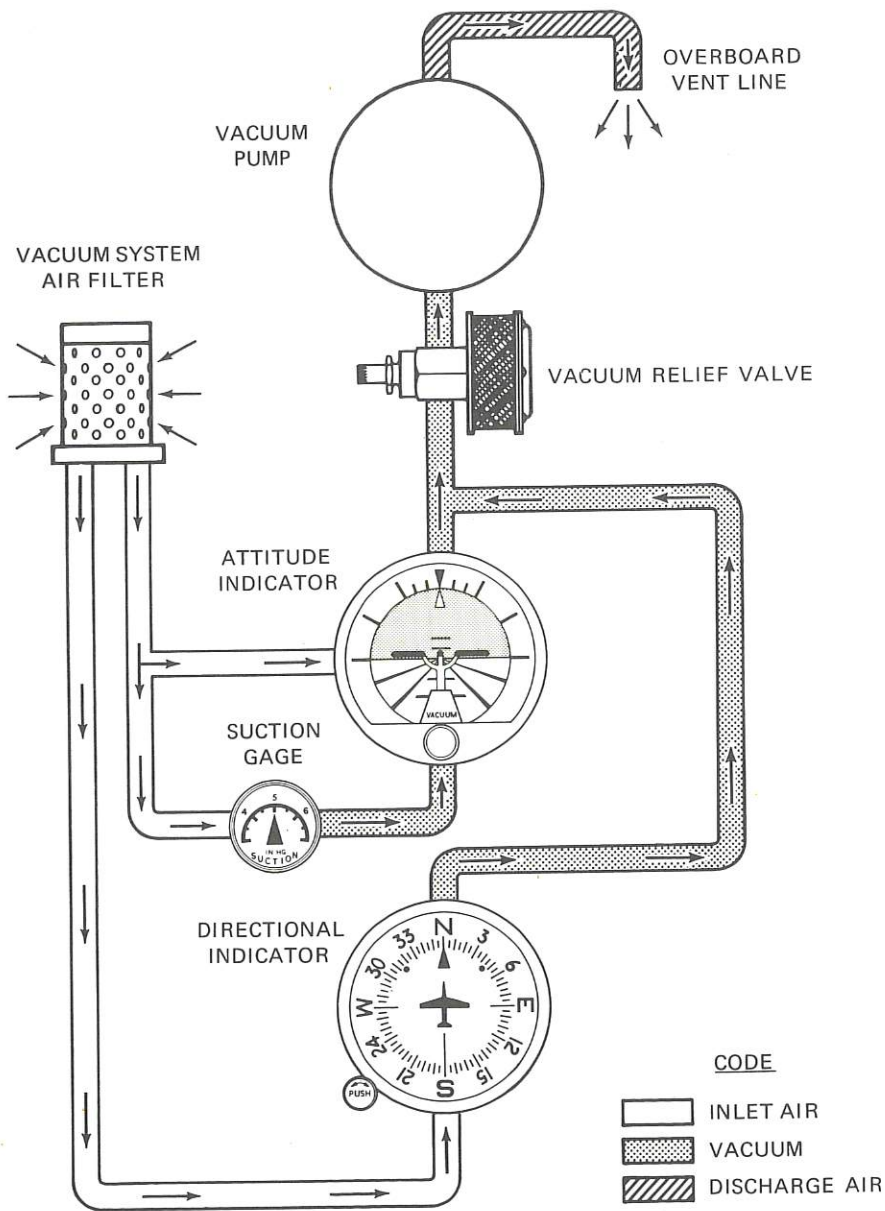

Figure 7-9. Vacuum System

adjustment of the miniature airplane to the horizon bar for a more accurate flight attitude indication.

DIRECTIONAL INDICATOR

A directional indicator displays airplane heading on a compass card in relation to a fixed simulated airplane image and index. The indicator will precess slightly over a period of time. Therefore, the compass card should be set in accordance with the magnetic compass just prior to takeoff, and occasionally re-adjusted on extended flights. A knob on the lower left edge of the instrument is used to adjust the compass card to correct for precession.

SUCTION GAGE

The suction gage, located on the left side of the instrument panel above the fuel gages, is calibrated in inches of mercury and indicates suction available for operation of the attitude and directional indicators. The desired suction range is 4.5 to 5.4 inches of mercury. A suction reading below this range may indicate a system malfunction or improper adjustment, and in this case, the indicators should not be considered reliable.

STALL WARNING SYSTEM

The airplane is equipped with a pneumatic-type stall warning system consisting of an inlet in the leading edge of the left wing, an air-operated horn near the upper left corner of the windshield, and associated plumbing. As the airplane approaches a stall, the low pressure on the upper surface of the wings moves forward around the leading edge of the wings. This low pressure creates a differential pressure in the stall warning system which draws air through the warning horn, resulting in an audible warning at 5 to 10 knots above stall in all flight conditions.

The stall warning system should be checked during the preflight inspection by placing a clean handkerchief over the vent opening and applying suction. A sound from the warning horn will confirm that the system is operative.

AVIONICS SUPPORT EQUIPMENT

If the airplane is equipped with avionics, various avionics support equipment may also be installed. Equipment available includes two types of audio control panels, microphone-headset installations and control

surface static dischargers. The following paragraphs discuss these items. Description and operation of radio equipment is covered in Section 9 of this handbook.

AUDIO CONTROL PANEL

Two types of audio control panels (see figure 7-10) are available for this airplane, depending upon how many transmitters are included. The operational features of both audio control panels are similar and are discussed in the following paragraphs.

TRANSMITTER SELECTOR SWITCH

When the avionics package includes a maximum of two transmitters, a two-position toggle-type switch, labeled XMTR, is provided to switch the microphone to the transmitter the pilot desires to use. If the airplane avionics package includes a third transmitter, the transmitter selector switch is a three-position rotary-type switch, labeled XMTR SEL. The numbers 1, 2, or 1, 2 and 3 adjacent to the selector switches correspond to the first, second and third (from top to bottom) transmitters in the avionics stack. To select a transmitter, place the transmitter selector switch in the position number corresponding to the desired transmitter.

The action of selecting a particular transmitter using the transmitter selector switch simultaneously selects the audio amplifier associated with that transmitter to provide speaker audio. For example, if the number one transmitter is selected, the audio amplifier in the number one NAV/COM is also selected and is used for ALL speaker audio. In the event the audio amplifier in use fails, as evidenced by loss of all speaker audio, selecting an alternate transmitter will reestablish speaker audio using the alternate transmitter audio amplifier. Headset audio is not affected by audio amplifier operation.

AUDIO SELECTOR SWITCHES

Both audio control panels (see figure 7-10) incorporate three-position toggle-type audio selector switches for individual control of the audio from systems installed in the airplane. These switches allow receiver audio to be directed to the airplane speaker or to a headset, and heard singly or in combination with other receivers. To hear a particular receiver on the airplane speaker, place that receiver's audio selector switch in the up (SPEAKER) position. To listen to a receiver over a headset, place that receiver's audio selector switch in the down (PHONE) position. The center (OFF) position turns off all audio from the associated receiver.

USED WITH ONE OR TWO TRANSMITTERS

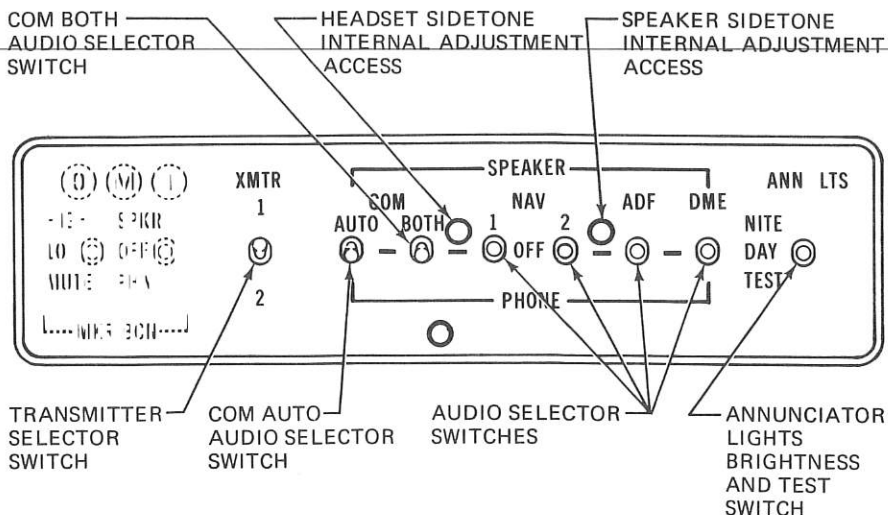

USED WITH THREE TRANSMITTERS

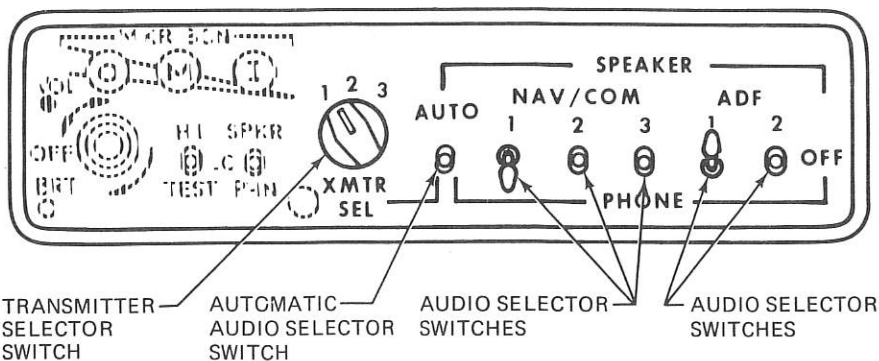

Figure 7-10. Audio Control Panel

NOTE

Volume level is adjusted using the individual receiver volume controls on each radio.

A special feature of the audio control panel used when one or two transmitters are installed is separate control of NAV and COM audio from the NAV/COM radios. With this installation, the audio selector switches labeled NAV, 1 and 2 select audio from the navigation receivers of the NAV/COM radios only. Communication receiver audio is selected by the switches labeled COM, AUTO and BOTH. Description and operation of these switches is described in later paragraphs.

When the audio control panel for three transmitters is installed, audio from both NAV and COM frequencies is combined, and is selected by the audio selector switches labeled NAV/COM, 1, 2 and 3.

COM AUTO AUDIO SELECTOR SWITCH

The audio control panel used with either one or two transmitters incorporates a three-position toggle switch, labeled COM AUTO, which is provided to automatically match the audio of the appropriate NAV/COM communications receiver to the transmitter selected by the transmitter selector switch. When the COM AUTO selector switch is placed in the up (SPEAKER) position, audio from the communications receiver selected by the transmitter selector switch will be heard on the airplane speaker. Switching the transmitter selector switch to the other transmitter automatically switches the other communications receiver audio to the speaker. This automatic audio switching feature may also be utilized when listening on a headset by placing the COM AUTO switch in the down (PHONE) position. If automatic audio selection is not desired, the COM AUTO selector switch should be placed in the center (OFF) position.

COM BOTH AUDIO SELECTOR SWITCH

The audio control panel used with either one or two transmitters incorporates a three-position toggle switch, labeled COM BOTH, which is provided to allow both COM receivers to be monitored at the same time. For example, if the COM AUTO switch is in the SPEAKER position, with the transmitter selector switch in the number one transmitter position, number one communications receiver audio will be heard on the airplane speaker. If it is also desired to monitor the number two communications receiver audio without changing the position of the transmitter selector switch, place the COM BOTH selector switch in the up (SPEAKER) position so that the number two communications receiver audio will be heard in addition to the number one communications receiver audio. This feature can also be used when listening on a headset by placing the COM

BOTH audio selector switch in the down (PHONE) position.

NOTE

The combination of placing the COM AUTO switch in the SPEAKER position and the COM BOTH switch in the PHONE position (or vice versa) is not normally recommended as it will cause audio from both communications receivers (and any other navigation receiver with its audio selector switch in the PHONE position) to be heard on both the airplane speaker and the headset simultaneously.

AUTO AUDIO SELECTOR SWITCH

The audio control panel used with three transmitters incorporates a three-position toggle switch, labeled AUTO, which is provided to automatically match the audio of the appropriate NAV/COM receiver to the selected transmitter. To utilize this automatic feature, leave all NAV/COM audio selector switches in the center (OFF) position, and place the AUTO selector switch in either the SPEAKER or PHONE position, as desired. Once the AUTO selector switch is positioned, the pilot may then select any transmitter and its associated NAV/COM receiver audio simultaneously with the transmitter selector switch. If automatic audio selection is not desired, the AUTO selector switch should be placed in the center (OFF) position.

NOTE

If the NAV/COM audio selector switch corresponding to the selected transmitter is in the PHONE position with the AUTO selector switch in the SPEAKER position, all audio selector switches placed in the PHONE position will automatically be connected to both the airplane speaker and any headsets in use.

ANNUNCIATOR LIGHTS BRIGHTNESS AND TEST SWITCH

The audio control panel used with either one or two transmitters incorporates a three-position toggle-type switch to control the brightness level of the marker beacon indicator lights (and certain other annunciator lights associated with avionics equipment). When the switch is placed in the center (DAY) position, the indicator lights will show full bright. When this switch is placed in the up (NITE) position, the lights are set to a reduced level for typical night operations and can be further adjusted using the RADIO LT dimming rheostat knob. The down (TEST) position illuminates all lamps (except the ARC light in the NAV indicators) which are controlled by the switch to the full bright level to verify lamp operation.

SIDETONE OPERATION

Cessna radios are equipped with sidetone capability (monitoring of the operator's own voice transmission). While adjusting sidetone, be aware that if the sidetone volume level is set too high, audio feedback (squeal) may result when transmitting.

When the airplane has one or two transmitters, sidetone is provided in both the speaker and headset anytime the COM AUTO selector switch is utilized. Placing the COM AUTO selector switch in the OFF position will eliminate sidetone. Sidetone internal adjustments are available to the pilot through the front of the audio control panel (see figure 7-10). Adjustment can be made by removing the appropriate plug-button from the audio control panel (left button for headset adjustment and right button for speaker adjustment), inserting a small screwdriver into the adjustment potentiometer and rotating it clockwise to increase the sidetone volume level.

When the airplane has three transmitters, sidetone will be heard on either the speaker or a headset as selected with the AUTO selector switch. Sidetone may be eliminated by placing the AUTO selector switch in the OFF position, and utilizing the individual audio selector switches. Adjustment of speaker and headset sidetone volume can only be accomplished by adjusting the sidetone potentiometers located inside the audio control panel.

NOTE

Sidetone is not available on HF transceivers (Type PT10-A and ASB-125), when installed.

MICROPHONE-HEADSET INSTALLATIONS

Three types of microphone-headset installations are offered. The standard system provided with avionics equipment includes a hand-held microphone and separate headset. The keying switch for this microphone is on the microphone. Two optional microphone-headset installations are also available; these feature a single-unit microphone-headset combination which permits the pilot to conduct radio communications without interrupting other control operations to handle a hand-held microphone. One microphone-headset combination is offered without a padded headset and the other version has a padded headset. The microphone-headset combinations utilize a remote keying switch located on the left grip of the pilot's control wheel. The microphone and headset jacks are located near

the lower left corner of the instrument panel. Audio to all three headsets is controlled by the individual audio selector switches and adjusted for volume level by using the selected receiver volume controls.

NOTE

When transmitting, the pilot should key the microphone, place the microphone as close as possible to the lips and speak directly into it.

STATIC DISCHARGERS

If frequent IFR flights are planned, installation of wick-type static dischargers is recommended to improve radio communications during flight through dust or various forms of precipitation (rain, snow or ice crystals). Under these conditions, the build-up and discharge of static electricity from the trailing edges of the wings, rudder, elevator, propeller tips and radio antennas can result in loss of usable radio signals on all communications and navigation radio equipment. Usually the ADF is first to be affected and VHF communication equipment is the last to be affected.

Installation of static dischargers reduces interference from precipitation static, but it is possible to encounter severe precipitation static conditions which might cause the loss of radio signals, even with static dischargers installed. Whenever possible, avoid known severe precipitation areas to prevent loss of dependable radio signals. If avoidance is impractical, minimize airspeed and anticipate temporary loss of radio signals while in these areas.

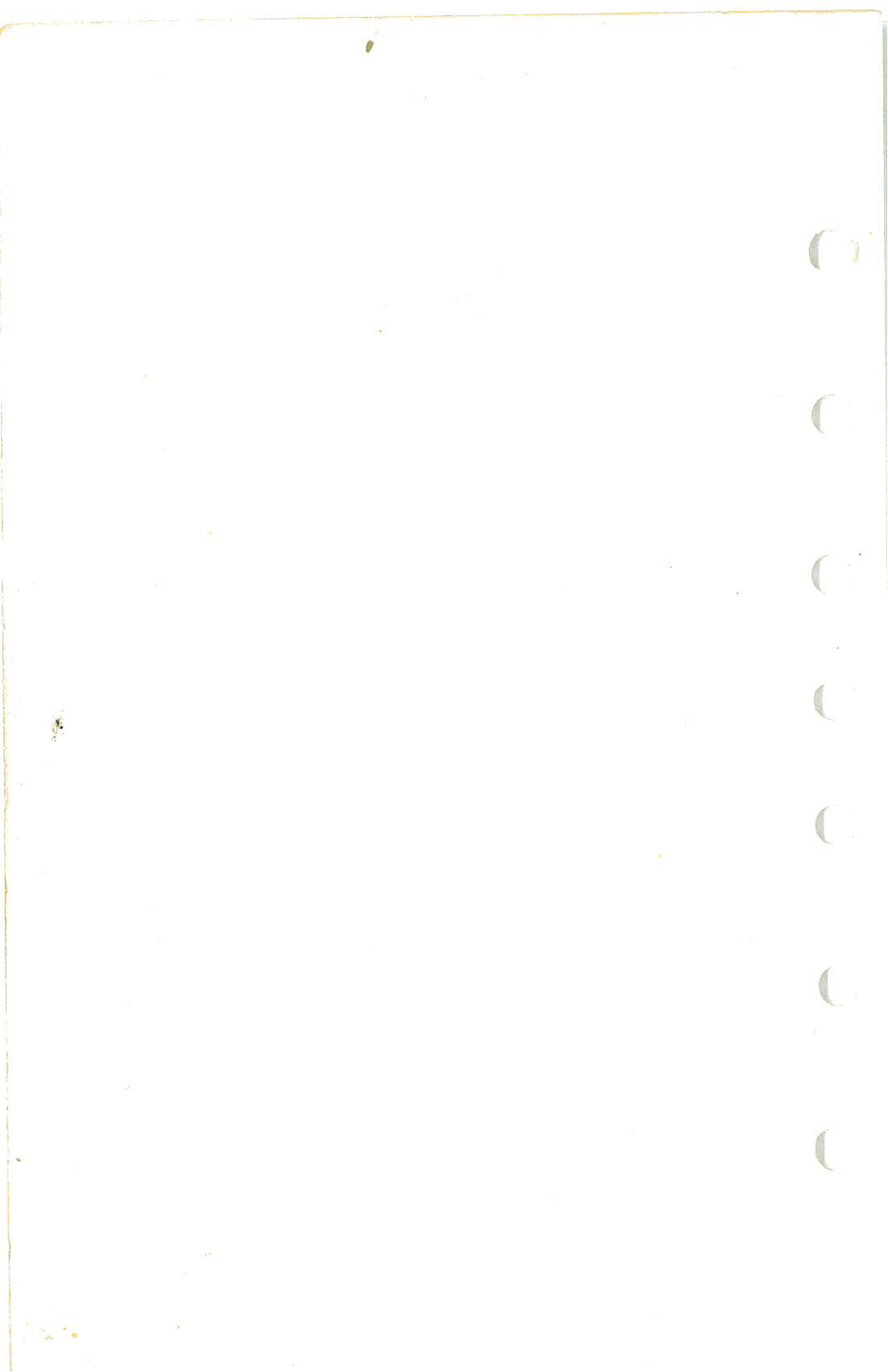

SECTION 8

AIRPLANE HANDLING, SERVICE & MAINTENANCE

TABLE OF CONTENTS

	Page
Introduction	8-3
Identification Plate	8-3
Owner Follow-Up System	8-3
Publications	8-3
Airplane File	8-4
Airplane Inspection Periods	8-5
FAA Required Inspections	8-5
Cessna Progressive Care	8-6
Cessna Customer Care Program	8-6
Pilot Conducted Preventive Maintenance	8-7
Alterations Or Repairs	8-7
Ground Handling	8-7
Towing	8-7
Parking	8-8
Tie-Down	8-8
Jacking	8-8
Leveling	8-9
Flyable Storage	8-9
Servicing	8-10
Engine Oil	8-10
Fuel	8-11
Landing Gear	8-14
Cleaning And Care	8-14
Windshield-Windows	8-14
Painted Surfaces	8-15
Propeller Care	8-16
Engine Care	8-16
Interior Care	8-16

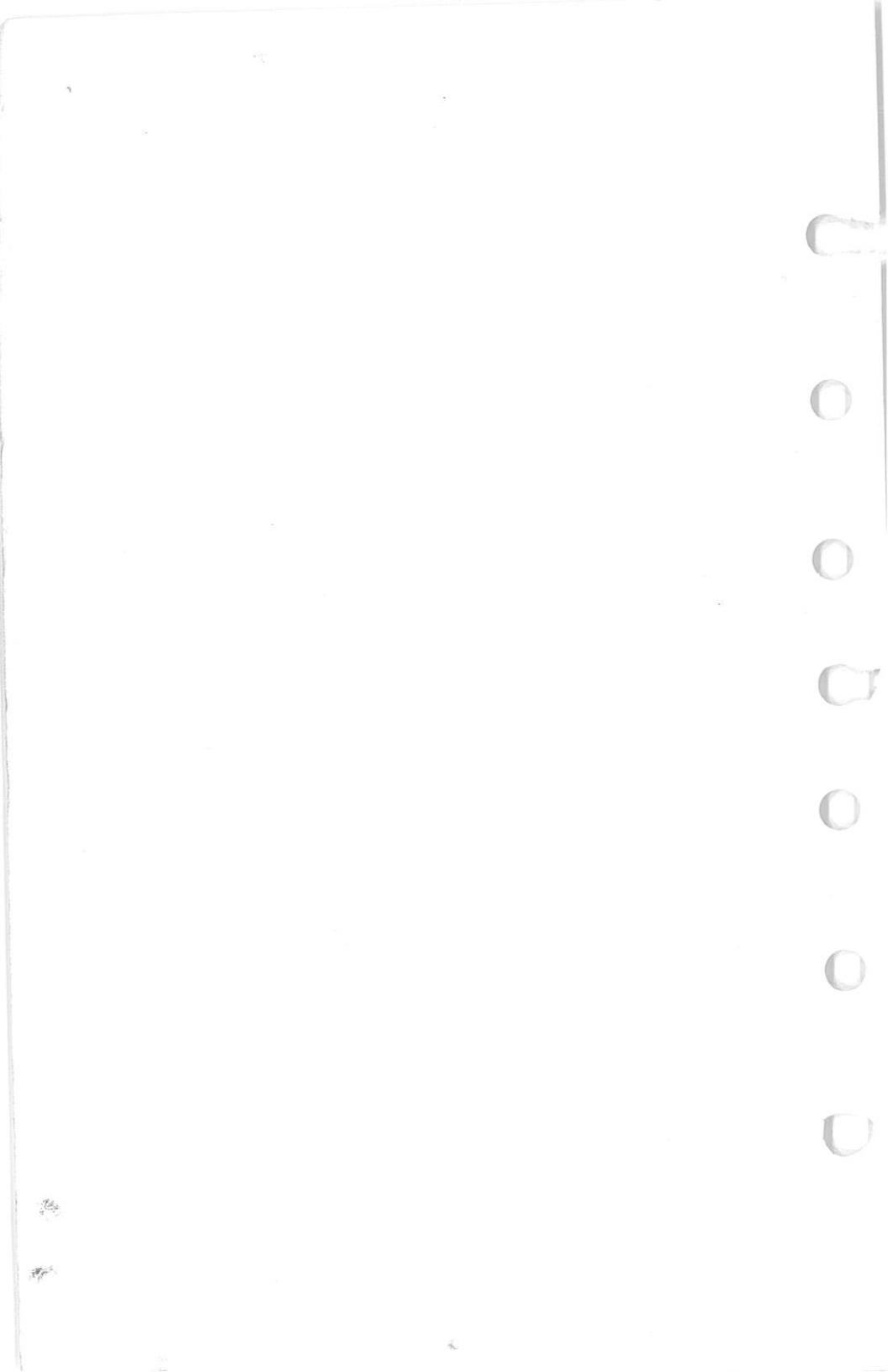

INTRODUCTION

This section contains factory-recommended procedures for proper ground handling and routine care and servicing of your Cessna. It also identifies certain inspection and maintenance requirements which must be followed if your airplane is to retain that new-plane performance and dependability. It is wise to follow a planned schedule of lubrication and preventive maintenance based on climatic and flying conditions encountered in your locality.

Keep in touch with your Cessna Dealer and take advantage of his knowledge and experience. He knows your airplane and how to maintain it. He will remind you when lubrications and oil changes are necessary, and about other seasonal and periodic services.

IDENTIFICATION PLATE

All correspondence regarding your airplane should include the SERIAL NUMBER. The Serial Number, Model Number, Production Certificate Number (PC) and Type Certificate Number (TC) can be found on the Identification Plate, located on the lower part of the left forward doorpost. Located adjacent to the Identification Plate is a Finish and Trim Plate which contains a code describing the interior color scheme and exterior paint combination of the airplane. The code may be used in conjunction with an applicable Parts Catalog if finish and trim information is needed.

OWNER FOLLOW-UP SYSTEM

Your Cessna Dealer has an Owner Follow-Up System to notify you when he receives information that applies to your Cessna. In addition, if you wish, you may choose to receive similar notification, in the form of Service Letters, directly from the Cessna Customer Services Department. A subscription form is supplied in your Customer Care Program book for your use, should you choose to request this service. Your Cessna Dealer will be glad to supply you with details concerning these follow-up programs, and stands ready, through his Service Department, to supply you with fast, efficient, low-cost service.

PUBLICATIONS

Various publications and flight operation aids are furnished in the

**SECTION 8
HANDLING, SERVICE
& MAINTENANCE**

**CESSNA
MODEL R172K**

airplane when delivered from the factory. These items are listed below.

- CUSTOMER CARE PROGRAM BOOK
- PILOT'S OPERATING HANDBOOK AND FAA APPROVED AIRPLANE FLIGHT MANUAL
- AVIONICS OPERATION GUIDE
- PILOT'S CHECKLISTS
- POWER COMPUTER
- CUSTOMER CARE DEALER DIRECTORY
- DO'S AND DON'TS ENGINE BOOKLET

The following additional publications, plus many other supplies that are applicable to your airplane, are available from your Cessna Dealer.

- INFORMATION MANUAL (Contains Pilot's Operating Handbook Information)
- SERVICE MANUALS AND PARTS CATALOGS FOR YOUR:
AIRPLANE
ENGINE AND ACCESSORIES
AVIONICS AND AUTOPILOT

Your Cessna Dealer has a Customer Care Supplies Catalog covering all available items, many of which he keeps on hand. He will be happy to place an order for any item which is not in stock.

NOTE

A Pilot's Operating Handbook and FAA Approved Airplane Flight Manual which is lost or destroyed may be replaced by contacting your Cessna Dealer or writing directly to the Customer Services Department, Cessna Aircraft Company, Wichita, Kansas. An affidavit containing the owner's name, airplane serial number and registration number must be included in replacement requests since the Pilot's Operating Handbook and FAA Approved Airplane Flight Manual is identified for specific airplanes only.

AIRPLANE FILE

There are miscellaneous data, information and licenses that are a part of the airplane file. The following is a checklist for that file. In addition, a periodic check should be made of the latest Federal Aviation Regulations to ensure that all data requirements are met.

- A. To be displayed in the airplane at all times:
 - 1. Aircraft Airworthiness Certificate (FAA Form 8100-2).
 - 2. Aircraft Registration Certificate (FAA Form 8050-3).
 - 3. Aircraft Radio Station License, if transmitter installed (FCC Form 556).
- B. To be carried in the airplane at all times:
 - 1. Pilot's Operating Handbook and FAA Approved Airplane Flight Manual.
 - 2. Weight and Balance, and associated papers (latest copy of the Repair and Alteration Form, FAA Form 337, if applicable).
 - 3. Equipment List.
- C. To be made available upon request:
 - 1. Airplane Log Book.
 - 2. Engine Log Book.

Most of the items listed are required by the United States Federal Aviation Regulations. Since the Regulations of other nations may require other documents and data, owners of airplanes not registered in the United States should check with their own aviation officials to determine their individual requirements.

Cessna recommends that these items, plus the Pilot's Checklists, Power Computer, Customer Care Program book and Customer Care Card, be carried in the airplane at all times.

AIRPLANE INSPECTION PERIODS

FAA REQUIRED INSPECTIONS

As required by Federal Aviation Regulations, all civil aircraft of U.S. registry must undergo a complete inspection (annual) each twelve calendar months. In addition to the required ANNUAL inspection, aircraft operated commercially (for hire) must have a complete inspection every 100 hours of operation.

The FAA may require other inspections by the issuance of airworthiness directives applicable to the airplane, engine, propeller and components. It is the responsibility of the owner/operator to ensure compliance with all applicable airworthiness directives and, when the inspections are repetitive, to take appropriate steps to prevent inadvertent noncompliance.

In lieu of the 100 HOUR and ANNUAL inspection requirements, an airplane may be inspected in accordance with a progressive inspection schedule, which allows the work load to be divided into smaller operations that can be accomplished in shorter time periods.

The CESSNA PROGRESSIVE CARE PROGRAM has been developed to provide a modern progressive inspection schedule that satisfies the complete airplane inspection requirements of both the 100 HOUR and ANNUAL inspections as applicable to Cessna airplanes. The program assists the owner in his responsibility to comply with all FAA inspection requirements, while ensuring timely replacement of life-limited parts and adherence to factory-recommended inspection intervals and maintenance procedures.

CESSNA PROGRESSIVE CARE

The Cessna Progressive Care Program has been designed to help you realize maximum utilization of your airplane at a minimum cost and downtime. Under this program, your airplane is inspected and maintained in four operations at 50-hour intervals during a 200-hour period. The operations are recycled each 200 hours and are recorded in a specially provided Aircraft Inspection Log as each operation is conducted.

The Cessna Aircraft Company recommends Progressive Care for airplanes that are being flown 200 hours or more per year, and the 100-hour inspection for all other airplanes. The procedures for the Progressive Care Program and the 100-hour inspection have been carefully worked out by the factory and are followed by the Cessna Dealer Organization. The complete familiarity of Cessna Dealers with Cessna equipment and factory-approved procedures provides the highest level of service possible at lower cost to Cessna owners.

Regardless of the inspection method selected by the owner, he should keep in mind that FAR Part 43 and FAR Part 91 establishes the requirement that properly certified agencies or personnel accomplish all required FAA inspections and most of the manufacturer recommended inspections.

CESSNA CUSTOMER CARE PROGRAM

Specific benefits and provisions of the CESSNA WARRANTY plus other important benefits for you are contained in your CUSTOMER CARE PROGRAM book supplied with your airplane. You will want to thoroughly review your Customer Care Program book and keep it in your airplane at all times.

Coupons attached to the Program book entitle you to an initial inspection and either a Progressive Care Operation No. 1 or the first 100-hour inspection within the first 6 months of ownership at no charge to you. If you take delivery from your Dealer, the initial inspection will have been performed before delivery of the airplane to you. If you pick up your airplane at the factory, plan to take it to your Dealer reasonably soon after you take delivery, so the initial inspection may be performed allowing the

Dealer to make any minor adjustments which may be necessary.

You will also want to return to your Dealer either at 50 hours for your first Progressive Care Operation, or at 100 hours for your first 100-hour inspection depending on which program you choose to establish for your airplane. While these important inspections will be performed for you by any Cessna Dealer, in most cases you will prefer to have the Dealer from whom you purchased the airplane accomplish this work.

PILOT CONDUCTED PREVENTIVE MAINTENANCE

A certified pilot who owns or operates an airplane not used as an air carrier is authorized by FAR Part 43 to perform limited maintenance on his airplane. Refer to FAR Part 43 for a list of the specific maintenance operations which are allowed.

NOTE

Pilots operating airplanes of other than U.S. registry should refer to the regulations of the country of certification for information on preventive maintenance that may be performed by pilots.

A Service Manual should be obtained prior to performing any preventive maintenance to ensure that proper procedures are followed. Your Cessna Dealer should be contacted for further information or for required maintenance which must be accomplished by appropriately licensed personnel.

ALTERATIONS OR REPAIRS

It is essential that the FAA be contacted **prior** to any alterations on the airplane to ensure that airworthiness of the airplane is not violated. Alterations or repairs to the airplane must be accomplished by licensed personnel.

GROUND HANDLING

TOWING

The airplane is most easily and safely maneuvered by hand with the tow-bar attached to the nose wheel. When towing with a vehicle, do not exceed the nose gear turning angle of 30° either side of center, or damage to the gear will result. If the airplane is towed or pushed over a rough surface during hangaring, watch that the normal cushioning action of the nose strut does not cause excessive vertical movement of the tail and the resulting contact with low hangar doors or structure. A flat nose tire or

deflated strut will also increase tail height.

PARKING

When parking the airplane, head into the wind and set the parking brakes. Do not set the parking brakes during cold weather when accumulated moisture may freeze the brakes, or when the brakes are overheated. Install the control wheel lock and chock the wheels. In severe weather and high wind conditions, tie the airplane down as outlined in the following paragraph.

TIE-DOWN

Proper tie-down procedure is the best precaution against damage to the parked airplane by gusty or strong winds. To tie-down the airplane securely, proceed as follows:

1. Set the parking brake and install the control wheel lock.
2. Install a surface control lock over the fin and rudder.
3. Tie sufficiently strong ropes or chains (700 pounds tensile strength) to the wing, tail, and nose tie-down fittings and secure each rope or chain to a ramp tie-down.
4. Install a pitot tube cover.

JACKING

When a requirement exists to jack the entire airplane off the ground, or when wing jack points are used in the jacking operation, refer to the Service Manual for specific procedures and equipment required.

Individual main gear may be jacked by using the jack pad which is incorporated in the main landing gear strut step bracket. When using the individual gear strut jack pad, flexibility of the gear strut will cause the main wheel to slide inboard as the wheel is raised, tilting the jack. The jack must then be lowered for a second jacking operation. **Do not** jack both main wheels simultaneously using the individual main gear jack pads.

If nose gear maintenance is required, the nose wheel may be raised off the ground by pressing down on a tailcone bulkhead, just forward of the horizontal stabilizer, and allowing the tail to rest on the tail tie-down ring.

NOTE

Do not apply pressure on the elevator or outboard stabilizer surfaces. When pushing on the tailcone, always apply pressure at a bulkhead to avoid buckling the skin.

To assist in raising and holding the nose wheel off the ground, weight down the tail by placing sand-bags, or suitable weights, on each side of the

horizontal stabilizer, next to the fuselage. If ground anchors are available, the tail should be securely tied down.

NOTE

Ensure that the nose will be held off the ground under all conditions by means of suitable stands or supports under weight supporting bulkheads near the nose of the airplane.

LEVELING

Longitudinal leveling of the airplane is accomplished by placing a level on leveling screws located on the left side of the tailcone. Deflate the nose tire and/or lower or raise the nose strut to properly center the bubble in the level. Corresponding points on both upper door sills may be used to level the airplane laterally.

FLYABLE STORAGE

Airplanes placed in non-operational storage for a maximum of 30 days or those which receive only intermittent operational use for the first 25 hours are considered in flyable storage status. Every seventh day during these periods, the propeller should be rotated by hand through five revolutions. This action "limbers" the oil and prevents any accumulation of corrosion on engine cylinder walls.

WARNING

For maximum safety, check that the ignition switch is OFF, the throttle is closed, the mixture control is in the idle cut-off position, and the airplane is secured before rotating the propeller by hand. Do not stand within the arc of the propeller blades while turning the propeller.

After 30 days, the airplane should be flown for 30 minutes or a ground runup should be made just long enough to produce an oil temperature within the lower green arc range. Excessive ground runup should be avoided.

Engine runup also helps to eliminate excessive accumulation of water in the fuel system and other air spaces in the engine. Keep fuel tanks full to minimize condensation in the tanks. Keep the battery fully charged to prevent the electrolyte from freezing in cold weather. If the airplane is to be stored temporarily, or indefinitely, refer to the Service Manual for proper storage procedures.

SERVICING

In addition to the PREFLIGHT INSPECTION covered in Section 4, COMPLETE servicing, inspection, and test requirements for your airplane are detailed in the Service Manual. The Service Manual outlines all items which require attention at 50, 100, and 200 hour intervals plus those items which require servicing, inspection, and/or testing at special intervals.

Since Cessna Dealers conduct all service, inspection, and test procedures in accordance with applicable Service Manuals, it is recommended that you contact your Cessna Dealer concerning these requirements and begin scheduling your airplane for service at the recommended intervals.

Cessna Progressive Care ensures that these requirements are accomplished at the required intervals to comply with the 100-hour or ANNUAL inspection as previously covered.

Depending on various flight operations, your local Government Aviation Agency may require additional service, inspections, or tests. For these regulatory requirements, owners should check with local aviation officials where the airplane is being operated.

For quick and ready reference, quantities, materials, and specifications for frequently used service items are as follows.

ENGINE OIL

GRADE -- Aviation Grade SAE 20W-50 or SAE 50 above 40°F (4°C).

Aviation Grade SAE 20W-50 or SAE 30 below 40°F (4°C).

Multi-viscosity oil with a range of SAE 20W-50 is recommended for improved starting in cold weather. Ashless dispersant oil, conforming to Continental Motors Specification MHS-24 (and all revisions thereto), **must be used**.

NOTE

Your Cessna was delivered from the factory with a corrosion preventive aircraft engine oil. If oil must be added during the first 25 hours, use only aviation grade straight mineral oil conforming to Specification No. MIL-L-6082.

CAPACITY OF ENGINE SUMP -- 8 Quarts.

Do not operate on less than 6 quarts. To minimize loss of oil through breather, fill to 7 quart level for normal flights of less than 3 hours. For extended flight, fill to 8 quarts. These quantities refer to oil dipstick level readings. During oil and oil filter changes, one additional quart is required when the filter is changed.

OIL AND OIL FILTER CHANGE --

After the first 25 hours of operation, drain engine oil sump and replace filter. Refill sump with straight mineral oil and use until a total of 50 hours has accumulated or oil consumption has stabilized; then change to dispersant oil. Drain the engine oil sump and replace the filter each 50 hours thereafter. The oil change interval may be extended to 100-hour intervals, providing the oil filter is changed at 50-hour intervals. Change engine oil at least every 6 months even though less than the recommended hours have accumulated. Reduce intervals for prolonged operation in dusty areas, cold climates, or when short flights and long idle periods result in sludging conditions.

NOTE

During the first 25-hour oil and filter change, a general inspection of the overall engine compartment is required. Items which are not normally checked during a preflight inspection should be given special attention. Hoses, metal lines and fittings should be inspected for signs of oil and fuel leaks, and checked for abrasions, chafing, security, proper routing and support, and evidence of deterioration. Inspect the intake and exhaust systems for cracks, evidence of leakage, and security of attachment. Engine controls and linkages should be checked for freedom of movement through their full range, security of attachment, and evidence of wear. Inspect wiring for security, chafing, burning, defective insulation, loose or broken terminals, heat deterioration, and corroded terminals. A periodic check of these items during subsequent servicing operations is recommended.

FUEL

APPROVED FUEL GRADES (AND COLORS) --

100LL Grade Aviation Fuel (Blue).

100 (Formerly 100/130) Grade Aviation Fuel (Green).

NOTE

Isopropyl alcohol or ethylene glycol monomethyl ether may be added to the fuel supply in quantities not to exceed 1% or .15% by volume, respectively, of the total. Refer to Fuel Additives in later paragraphs for additional information.

CAPACITY EACH STANDARD TANK -- 26 Gallons.
CAPACITY EACH LONG RANGE TANK -- 34 Gallons.

NOTE

To ensure maximum fuel capacity when refueling and minimize cross-feeding when parked on a sloping surface, place the fuel selector valve in either LEFT or RIGHT position.

NOTE

Service the fuel system after each flight, and keep fuel tanks full to minimize condensation in the tanks.

FUEL ADDITIVES --

Strict adherence to recommended preflight draining instructions as called for in Section 4 will eliminate any free water accumulations from the tank sumps. While small amounts of water may still remain in solution in the gasoline, it will normally be consumed and go unnoticed in the operation of the engine.

One exception to this can be encountered when operating under the combined effect of: (1) use of certain fuels, with (2) high humidity conditions on the ground (3) followed by flight at high altitude and low temperature. Under these unusual conditions, small amounts of water in solution can precipitate from the fuel stream and freeze in sufficient quantities to induce partial icing of the engine fuel system.

While these conditions are quite rare and will not normally pose a problem to owners and operators, they do exist in certain areas of the world and consequently must be dealt with, when encountered.

Therefore, to alleviate the possibility of fuel icing occurring under these unusual conditions, it is permissible to add isopropyl alcohol or ethylene glycol monomethyl ether (EGME) compound to the fuel supply.

The introduction of alcohol or EGME compound into the fuel provides two distinct effects: (1) it absorbs the dissolved water from the gasoline and (2) alcohol has a freezing temperature depressant effect.

Alcohol, if used, is to be blended with the fuel in a concentration of 1% by volume. Concentrations greater than 1% are not recommended since they can be detrimental to fuel tank materials.

The manner in which the alcohol is added to the fuel is significant because alcohol is most effective when it is completely dissolved in the fuel. To ensure proper mixing, the following is recommended:

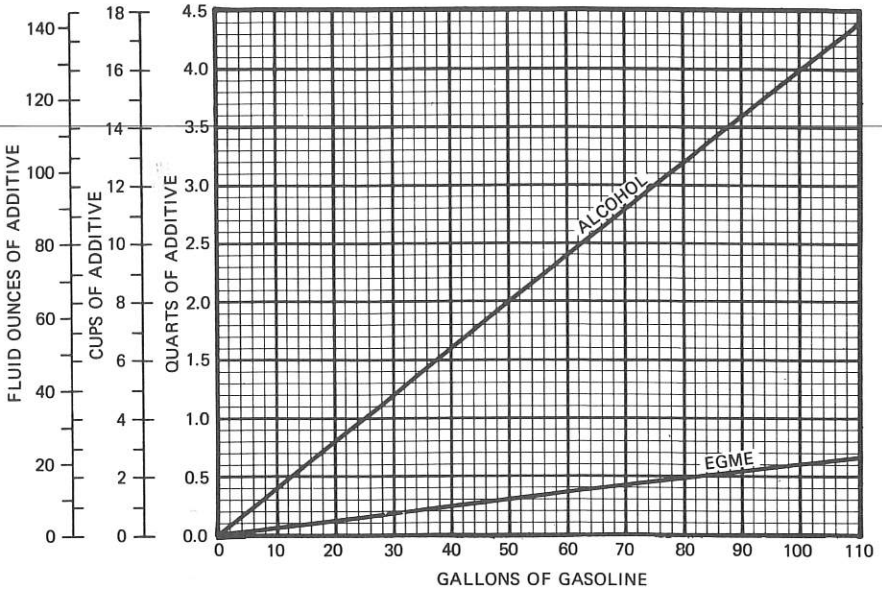

Figure 8-1. Additive Mixing Ratio

1. For best results, the alcohol should be added during the fueling operation by pouring the alcohol directly on the fuel stream issuing from the fueling nozzle.
2. An alternate method that may be used is to premix the complete alcohol dosage with some fuel in a separate clean container (approximately 2-3 gallon capacity) and then transferring this mixture to the tank prior to the fuel operation.

Any high quality isopropyl alcohol may be used, such as Anti-Icing Fluid (MIL-F-5566) or Isopropyl Alcohol (Federal Specification TT-I-735a). Figure 8-1 provides alcohol-fuel mixing ratio information.

Ethylene glycol monomethyl ether (EGME) compound, in compliance with MIL-I-27686 or Phillips PFA-55MB, if used, must be carefully mixed with the fuel in concentrations not to exceed .15% by volume. Figure 8-1 provides EGME-fuel mixing ratio information.

CAUTION

Mixing of the EGME compound with the fuel is extremely

important because a concentration in excess of that recommended (.15% by volume maximum) will result in detrimental effects to the fuel tanks, such as deterioration of protective primer and sealants and damage to O-rings and seals in the fuel system and engine components. Use only blending equipment that is recommended by the manufacturer to obtain proper proportioning.

CAUTION

Do not allow the concentrated EGME compound to come in contact with the airplane finish or fuel cell as damage can result.

Prolonged storage of the airplane will result in a water buildup in the fuel which "leeches out" the additive. An indication of this is when an excessive amount of water accumulates in the fuel tank sumps. The concentration can be checked using a differential refractometer. It is imperative that the technical manual for the differential refractometer be followed explicitly when checking the additive concentration.

LANDING GEAR

NOSE WHEEL TIRE PRESSURE -- 45 PSI on 5.00-5, 6-Ply Rated Tire.
MAIN WHEEL TIRE PRESSURE -- 38 PSI on 6.00-6, 6-Ply Rated Tires.
NOSE GEAR SHOCK STRUT --

Keep filled with MIL-H-5606 hydraulic fluid and inflated with air to 45 PSI. Do not over-inflate.

CLEANING AND CARE

WINDSHIELD-WINDOWS

The plastic windshield and windows should be cleaned with an aircraft windshield cleaner. Apply the cleaner sparingly with soft cloths, and rub with moderate pressure until all dirt, oil scum and bug stains are removed. Allow the cleaner to dry, then wipe it off with soft flannel cloths.

If a windshield cleaner is not available, the plastic can be cleaned with soft cloths moistened with Stoddard solvent to remove oil and grease.

NOTE

Never use gasoline, benzine, alcohol, acetone, fire extin-

guisher or anti-ice fluid, lacquer thinner or glass cleaner to clean the plastic. These materials will attack the plastic and may cause it to craze.

Follow by carefully washing with a mild detergent and plenty of water. Rinse thoroughly, then dry with a clean moist chamois. **Do not rub** the plastic with a dry cloth since this builds up an electrostatic charge which attracts dust. Waxing with a good commercial wax will finish the cleaning job. A thin, even coat of wax, polished out by hand with clean soft flannel cloths, will fill in minor scratches and help prevent further scratching.

Do not use a canvas cover on the windshield unless freezing rain or sleet is anticipated since the cover may scratch the plastic surface.

PAINTED SURFACES

The painted exterior surfaces of your new Cessna have a durable, long lasting finish and, under normal conditions, require no polishing or buffing. Approximately 10 days are required for the paint to cure completely; in most cases, the curing period will have been completed prior to delivery of the airplane. In the event that polishing or buffing is required within the curing period, it is recommended that the work be done by someone experienced in handling uncured paint. Any Cessna Dealer can accomplish this work.

Generally, the painted surfaces can be kept bright by washing with water and mild soap, followed by a rinse with water and drying with cloths or a chamois. Harsh or abrasive soaps or detergents which cause corrosion or scratches should never be used. Remove stubborn oil and grease with a cloth moistened with Stoddard solvent.

Waxing is unnecessary to keep the painted surfaces bright. However, if desired, the airplane may be waxed with a good automotive wax. A heavier coating of wax on the leading edges of the wings and tail and on the engine nose cap and propeller spinner will help reduce the abrasion encountered in these areas.

When the airplane is parked outside in cold climates and it is necessary to remove ice before flight, care should be taken to protect the painted surfaces during ice removal with chemical liquids. Isopropyl alcohol will satisfactorily remove ice accumulations without damaging the paint. While applying the de-icing solution, keep it away from the windshield and cabin windows since the alcohol will attack the plastic and may cause it to craze.

PROPELLER CARE

Preflight inspection of propeller blades for nicks, and wiping them occasionally with an oily cloth to clean off grass and bug stains will assure long, trouble-free service. Small nicks on the propeller, particularly near the tips and on the leading edges, should be dressed out as soon as possible since these nicks produce stress concentrations, and if ignored, may result in cracks. Never use an alkaline cleaner on the blades; remove grease and dirt with Stoddard solvent.

ENGINE CARE

The engine may be cleaned with Stoddard solvent, or equivalent, then dried thoroughly.

CAUTION

Particular care should be given to electrical equipment before cleaning. Cleaning fluids should not be allowed to enter magnetos, starter, alternator and the like. Protect these components before saturating the engine with solvents. All other openings should also be covered before cleaning the engine assembly. Caustic cleaning solutions should be used cautiously and should always be properly neutralized after their use.

INTERIOR CARE

To remove dust and loose dirt from the upholstery and carpet, clean the interior regularly with a vacuum cleaner.

Blot up any spilled liquid promptly with cleansing tissue or rags. Don't pat the spot; press the blotting material firmly and hold it for several seconds. Continue blotting until no more liquid is taken up. Scrape off sticky materials with a dull knife, then spot-clean the area.

Oily spots may be cleaned with household spot removers, used sparingly. Before using any solvent, read the instructions on the container and test it on an obscure place on the fabric to be cleaned. Never saturate the fabric with a volatile solvent; it may damage the padding and backing materials.

Soiled upholstery and carpet may be cleaned with foam-type detergent, used according to the manufacturer's instructions. To minimize wetting the fabric, keep the foam as dry as possible and remove it with a vacuum cleaner.

If your airplane is equipped with leather seating, cleaning of the seats is accomplished using a soft cloth or sponge dipped in mild soap suds. The soap suds, used sparingly, will remove traces of dirt and grease. The soap should be removed with a clean damp cloth.

The plastic trim, headliner, instrument panel and control knobs need only be wiped off with a damp cloth. Oil and grease on the control wheel and control knobs can be removed with a cloth moistened with Stoddard solvent. Volatile solvents, such as mentioned in paragraphs on care of the windshield, must never be used since they soften and craze the plastic.

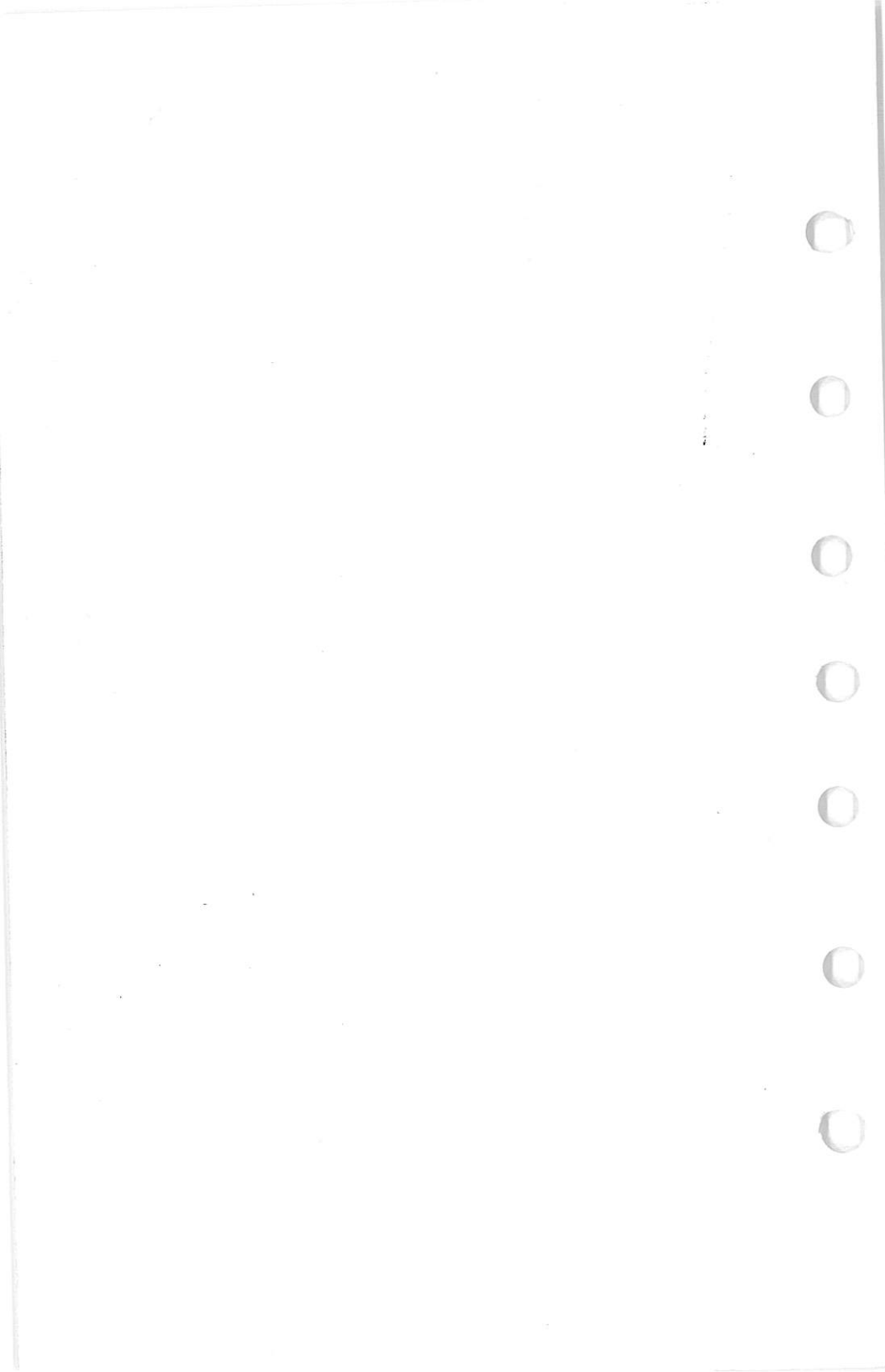

SECTION 9 SUPPLEMENTS

(Optional Systems Description & Operating Procedures)

TABLE OF CONTENTS

Introduction

Supplements (Major Configuration Variations):

- 1 Floatplane (48 pages)

Supplements (General):

- 2 Circulation Fan System (4 pages)
3 Digital Clock (4 pages)
4 Ground Service Plug Receptacle (4 pages)
5 Strobe Light System (2 pages)
6 Winterization Kit (2 pages)

Supplements (Avionics):

- 7 DME (Type 190) (4 pages)
8 Emergency Locator Transmitter (ELT) (4 pages)
9 Foster Area Navigation System (Type 511) (8 pages)
10 HF Transceiver (Type PT10-A) (4 pages)
11 SSB HF Transceiver (Type ASB-125) (4 pages)
12 200A Navomatic Autopilot (Type AF-295B) (6 pages)
13 300 ADF (Type R-546E) (6 pages)
14 300 Nav/Com (Type RT-385A) (8 pages)
15 300 Transponder (Type RT-359A) And Optional
Altitude Encoder (Blind) (6 pages)
16 300 Transponder (Type RT-359A) And Optional
Encoding Altimeter (Type EA-401A) (6 pages)
17 300A Navomatic Autopilot (Type AF-395A) (6 pages)
18 400 Glide Slope (Type R-443B) (4 pages)
19 400 Marker Beacon (Type R-402A) (6 pages)
20 400 Transponder (Type RT-459A) And Optional
Altitude Encoder (Blind) (6 pages)
21 400 Transponder (Type RT-459A) And Optional
Encoding Altimeter (Type EA-401A) (6 pages)

INTRODUCTION

This section consists of a series of supplements, each covering a single optional system which may be installed in the airplane. Each supplement contains a brief description, and when applicable, operating limitations, emergency and normal procedures, and performance. As listed in the Table of Contents, the supplements are classified under the headings of major configuration variations, general and avionics, and have been provided with reference numbers. Also, the supplements are arranged alphabetically and numerically to make it easier to locate a particular supplement. Other routinely installed items of optional equipment, whose function and operational procedures do not require detailed instructions, are discussed in Section 7.

Limitations contained in the following supplements are FAA approved. Observance of these operating limitations is required by Federal Aviation Regulations.

J.P.INSTRUMENTS
PO BOX 7033
HUNTINGTON BEACH CA 92646

Airplane/Rotorcraft Flight Manual
Supplement No. 1
EGT-701 Rev B

FAA APPROVED
AIRPLANE/ROTORCRAFT FLIGHT MANUAL SUPPLEMENT OR
SUPPLEMENTAL AIRPLANE FLIGHT MANUAL (INCLUDING POH AND FAA AFM)
(FOR THOSE AIRCRAFT WITHOUT A BASIC AIRPLANE FLIGHT MANUAL)

EGT-701 TEMPERATURE INDICATOR
FOR

Single and Twin Reciprocating Engine Powered Aircraft as listed
on Master Eligibility List of

STC SA2586NM.

REG. NO. _____

SER. NO. _____

This Supplement must be attached to the FAA Approved Airplane/Rotorcraft Flight Manual when the J.P. Instruments EGT-701 is installed in accordance with Supplemental Type Certificate SA 2586NM. For those airplanes without a basic Airplane Flight Manual, the Supplemental AFM must be in the aircraft when the EGT-701 is installed.

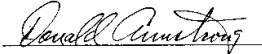

The information contained in this Airplane/Rotorcraft Flight Manual Supplement/ Supplemental Aircraft Flight Manual supplements or supersedes the basic manual/ placards only in those areas listed. For limitations, procedures and performance information not contained in this supplement, consult the basic Airplane Flight manual, Markings and Placards.

FAA APPROVED:



Manager, Flight Test Branch, ANM-160L
Federal Aviation Administration
Los Angeles Aircraft Certification Office
Transport Airplane Certification Directorate

Date: Nov. 12, 1992

Revision No.	Description	Affected Pages	Approval
Original	Complete Flight Manual Supplement for EGT-701	1 thru 4	 Mgr. Flt. Test Br. ANM-160L FAA, LA ACO Transport Airplane Directorate Date <u>11-12-92</u>
A	Added Fuel Flow features & Switch.	2 thru 4	 Mgr. Flt. Test Br. ANM-160L FAA, LA ACO Transport Airplane Directorate Date <u>12-13-96</u>
B	Added RPM and Manifold Pressure features	2 thru 4	 Mgr. Flt. Test Br. ANM-160L FAA, LA ACO Transport Airplane Directorate Date <u>6-17-99</u>

1-GENERAL

The EGT-701 temperature indicator displays temperature digitally and in analog format. The EGT as displayed is based on probes located near the exhaust outlet for each cylinder and the TIT probe, if installed, is adjacent to the turbo charger. These probes are not necessarily collocated with the primary probes therefore, EGT-701 may not indicate the same as the aircraft primary instruments. The analog display is an electronic bar graph (vertical columns, one per cylinder) of EGT & TIT temperatures presented as a percentage of 1650°F. Below the vertical columns the specific value for EGT and CHT are displayed digitally. The dot over the column indicates which cylinder's digital information is presently displayed. The missing bars at the base of the columns indicates the hottest and coldest Cylinder Head temperature trend. During Lean Find mode the leanest cylinder is displayed along with the fuel flow (optional) at that time. Depressing the LF and STEP button simultaneously brings up the adjustable scan rate function, OAT in °C or °F. Depress the LF button will change the value of the rate or OAT in °C or °F. Exit by Depressing STEP.

If the EGT-701 buttons are not depressed for 10 minutes the system will start scanning automatically. Depressing the STEP button will stop the automatic scan and index through all the functions available. During constant power cruise, if the LF button is depressed for five seconds the bargraph will level at mid scale. The leveled bars represent the peaks of each column. Each bar represents 10 °F and now acts as an EGT & TIT trend monitor, quickly showing an increase or decrease in temperature. Depress again to return to normal; nothing else is affected. With the fuel flow option there is a three position toggle switch. The positions are: 1) **EGT**, digital and bargraph display of temperatures, 2) **FF**, digital display of GPH, REM and USED Fuel. Temperature bargraph remains. 3) **Both**, cycles through everything installed. The data port output, sends RS232 serial data every 6-sec.

Options of Fuel Flow, TIT, OAT, IAT (induction air temp.), OIL, BAT (voltage) and are only displayed digitally with headlines after the number, as "230 OIL" or "14 GPH". A large value (50+) of "CLD" indicates shock cooling usually associated with rapid descents at low power. Optional functions not installed will not display. RPM is displayed constantly in the upper display with no alarms. MAP is shown in the scan display.

Alarm limits set for this instrument if different from JPI limits.

- CHT _____
- OIL _____ EGT 1340 F
- TIT _____
- DIF _____
- CLD _____
- BAT _____
- TECH _____
- DATE _____

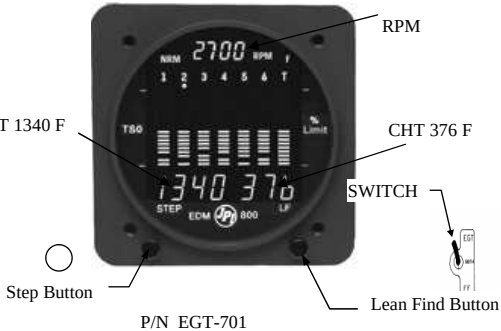

GENERAL (cont.)

An alarm causes the digital function to flash as soon as the particular limit is exceeded. Factory set alarm limits for CHT (450 °F) and OIL (230°F) are lower than the actual aircraft limits and can not be set by the pilot. The values may be adjusted to suit individual preference by a qualified technician. Other factory set alarm limits are: "BAT" Voltage 15.5/11.0 or 31.0/22.0 Hi/Lo as appropriate; "DIF" (differential Hi/Lo EGT) 500 °F, "TIT" 1650 °F Hi; "OIL" Lo 90 °F; "CLD" (Rate of change of cylinder head temperature in degrees per minute) -60 degrees/minute. The pilot should be aware of the setting of each alarm for his particular aircraft. An alarm is "Canceled" by holding the step button in for 5 seconds and seeing the word "OFF". Then, only that particular alarm is canceled. Canceled alarms will not appear again until the power has been removed and reapplied to the EGT-701. The entire display dims automatically depending on the ambient lighting.

The Cylinder Head with the Gasket probe and oil temperature will indicate generally higher temperatures than instruments provided by the aircraft manufacturer because the EGT-701 sensing thermocouples are not collocated with the primary instrument sensing probes. Therefore, airplane flight manual limitations based on primary instrument indication take precedence over those of the EGT-701

II OPERATING LIMITATIONS

- A. The EGT-701 may not replace any existing instrument or indicator required by the aircraft type design or operating limits.
- B. The EGT-701 display may not be used in lieu of, or to supersede, engine operating limitations established by the airframe or engine manufacturer during certification.

III. EMERGENCY PROCEDURES

No change

IV. NORMAL PROCEDURES

CAUTION

Comply with manufacturer's Airplane
Flight Manual leaning procedure.
Do not exceed applicable engine
or aircraft limitations.

After establishing desired cruise power depress the LF button to activate the Lean Find Mode. As the mixture is leaned, one column on the EGT-701 display will begin blinking, indicating the exhaust gas temperature for that cylinder has peaked showing its digital value along with the fuel flow (option) at that time. Continue with the leaning procedure as recommended by the aircraft manufacturer while monitoring the primary engine instruments and the EGT-701 display. Once the leaning procedure has been completed, depress the Step button briefly to exit the Lean Find Mode and enter the Monitor Mode.

FAA APPROVED 6/17/99

J.P. INSTRUMENTS
PO BOX 7033
HUNTINGTON BEACH CA 92646

Airplane/Rotorcraft Flight Manual
Supplement No. 1
EGT-701 Rev B

FAA APPROVED
AIRPLANE/ROTORCRAFT FLIGHT MANUAL SUPPLEMENT OR
SUPPLEMENTAL AIRPLANE FLIGHT MANUAL (INCLUDING POH AND FAA AFM)
(FOR THOSE AIRCRAFT WITHOUT A BASIC AIRPLANE FLIGHT MANUAL)

EGT-701 TEMPERATURE INDICATOR
FOR

Single and Twin Reciprocating Engine Powered Aircraft as listed
on Master Eligibility List of

STC SA2586NM.

REG. NO. N758RL

SER. NO. 3299

This Supplement must be attached to the FAA Approved Airplane/Rotorcraft Flight Manual when the J.P. Instruments EGT-701 is installed in accordance with Supplemental Type Certificate SA 2586NM. For those airplanes without a basic Airplane Flight Manual, the Supplemental AFM must be in the aircraft when the EGT-701 is installed.

Information contained in this Airplane/Rotorcraft Flight Manual Supplement/
Supplemental Aircraft Flight Manual supplements or supersedes the basic manual/ placards only in those areas listed. For limitations, procedures and performance information not contained in this supplement, consult the basic Airplane Flight manual, Markings and Placards.

FAA APPROVED:



Manager, Flight Test Branch, ANM-160L
Federal Aviation Administration
Los Angeles Aircraft Certification Office
Transport Airplane Certification Directorate

Date: Nov. 12, 1992

TAA: 2586-2

GENERAL (cont.)

An alarm causes the digital function to flash as soon as the particular limit is exceeded. Factory set alarm limits for CHT (450 °F) and OIL (230°F) are lower than the actual aircraft limits and can not be set by the pilot. The values may be adjusted to suit individual preference by a qualified technician. Other factory set alarm limits are: "BAT" Voltage 15.5/11.0 or 31.0/22.0 Hi/Lo as appropriate; "DIF" (differential Hi/Lo EGT) 500 °F, "TIT" 1650 °F Hi; "OIL" Lo 90 °F; "CLD" (Rate of change of cylinder head temperature in degrees per minute) -60 degrees/minute. The pilot should be aware of the setting of each alarm for his particular aircraft. An alarm is "Canceled" by holding the step button in for 5 seconds and seeing the word "OFF". Then, only that particular alarm is canceled. Canceled alarms will not appear again until the power has been removed and reapplied to the EGT-701. The entire display dims automatically depending on the ambient lighting.

The Cylinder Head with the Gasket probe and oil temperature will indicate generally higher temperatures than instruments provided by the aircraft manufacturer because the EGT-701 sensing thermocouples are not collocated with the primary instrument sensing probes. Therefore, airplane flight manual limitations based on primary instrument indication take precedence over those of the EGT-701

II OPERATING LIMITATIONS

- A. The EGT-701 may not replace any existing instrument or indicator required by the aircraft type design or operating limits.
- B. The EGT-701 display may not be used in lieu of, or to supersede, engine operating limitations established by the airframe or engine manufacturer during certification.

III. EMERGENCY PROCEDURES

No change

IV. NORMAL PROCEDURES

CAUTION

Comply with manufacturer's Airplane
Flight Manual leaning procedure.
Do not exceed applicable engine
or aircraft limitations.

After establishing desired cruise power depress the LF button to activate the Lean Find Mode. As the mixture is leaned, one column on the EGT-701 display will begin blinking, indicating the exhaust gas temperature for that cylinder has peaked showing its digital value along with the fuel flow (option) at that time. Continue with the leaning procedure as recommended by the aircraft manufacturer while monitoring the primary engine instruments and the EGT-701 display. Once the leaning procedure has been completed, depress the Step button briefly to exit the Lean Find Mode and enter the Monitor Mode.

HORTON STOL-CRAFT

FAA APPROVED FLIGHT MANUAL SUPPLEMENT

FOR

1979 CESSNA R172K AND R172K Float Plane

S/N 1722930 AND ON

WITH A HORTON STOL CONVERSION

SER. NO. R1723299

REG. NO. N758RL

This supplement must be included in Section 9 of the Pilot's Operating Handbook and FAA Approved Airplane Flight Manual when the HORTON STOL Conversion is installed in accordance with STC No. SA948CE.

The information contained herein supplements or supersedes the Airplane Flight Manual only in these areas listed herein. For limitation procedures, and performance information not contained in this supplement, consult the basic Pilot's Operating Handbook.

FAA APPROVED

Am Behn

DATE APPROVED May 20, 1982

for

Manager

Wichita Aircraft Certification Office
1801 Airport Road, Room 100
Mid-Continent Airport
Wichita, Kansas 67209

REVISED Oct. 15, 1990 to add Float Planes

HORTON STOL-CRAFT

SECTION 1 GENERAL

The HORTON STOL Conversion on the Cessna R172K consists of wing leading edge cuffs, drooped tips, stall fences, and aileron gap seals installed in accordance with STOL-CRAFT drawing 2050 sheet 4.

SECTION 2 LIMITATIONS

There is no change to the airplane limitations with the HORTON STOL-KIT installed.

SECTION 3 EMERGENCY PROCEDURES

There is no change to the airplane emergency procedures with the Horton STOL-KIT installed.

SECTION 4 NORMAL PROCEDURES

There is no change to the normal procedures with the installation of the Horton STOL-KIT.

SECTION 5 PERFORMANCE

The stall speeds, takeoff performance and landing performance are equal to or better than the performance of the unmodified Airplane.

FAA APPROVED

DATE APPROVED May 20, 1982

SUPPLEMENT

GROUND SERVICE PLUG RECEPTACLE

SECTION 1 GENERAL

The ground service plug receptacle permits the use of an external power source for cold weather starting and lengthy maintenance work on the electrical and electronic equipment. The receptacle is located behind a door on the left side of the fuselage near the aft edge of the cowling.

NOTE

If no avionics equipment is to be used or worked on, the avionics power switch should be turned off. If maintenance is required on the avionics equipment, it is advisable to utilize a battery cart external power source to prevent damage to the avionics equipment by transient voltage. Do not crank or start the engine with the avionics power switch turned on.

The battery and external power circuits have been designed to completely eliminate the need to "jumper" across the battery contactor to close it for charging a completely "dead" battery. A special fused circuit in the external power system supplies the needed "jumper" across the contacts so that with a "dead" battery and an external power source applied, turning the master switch ON will close the battery contactor.

SECTION 2

LIMITATIONS

The following information must be presented in the form of a placard located on the inside of the ground service plug access door.

CAUTION 24 VOLTS D.C.
This aircraft is equipped with alternator
and a negative ground system.
OBSERVE PROPER POLARITY
Reverse polarity will damage electrical
components.

SECTION 3

EMERGENCY PROCEDURES

There is no change to the airplane emergency procedures when the ground service plug receptacle is installed.

SECTION 4

NORMAL PROCEDURES

Just before connecting an external power source (generator type or battery cart), the avionics power switch should be turned off, and the master switch on.

WARNING

When turning on the master switch, using an external power source, or pulling the propeller through by hand, treat the propeller as if the ignition switch were on. Do not stand, nor allow anyone else to stand, within the arc of the propeller, since a loose or broken wire, or a component malfunction, could cause the propeller to rotate.

The ground service plug receptacle circuit incorporates a polarity reversal protection. Power from the external power source will flow only if the ground service plug is correctly connected to the airplane. If the plug is accidentally connected backwards, no power will flow to the electrical system, thereby preventing any damage to electrical equipment.

SECTION 5 PERFORMANCE

There is no change to the airplane performance when the ground service plug receptacle is installed.

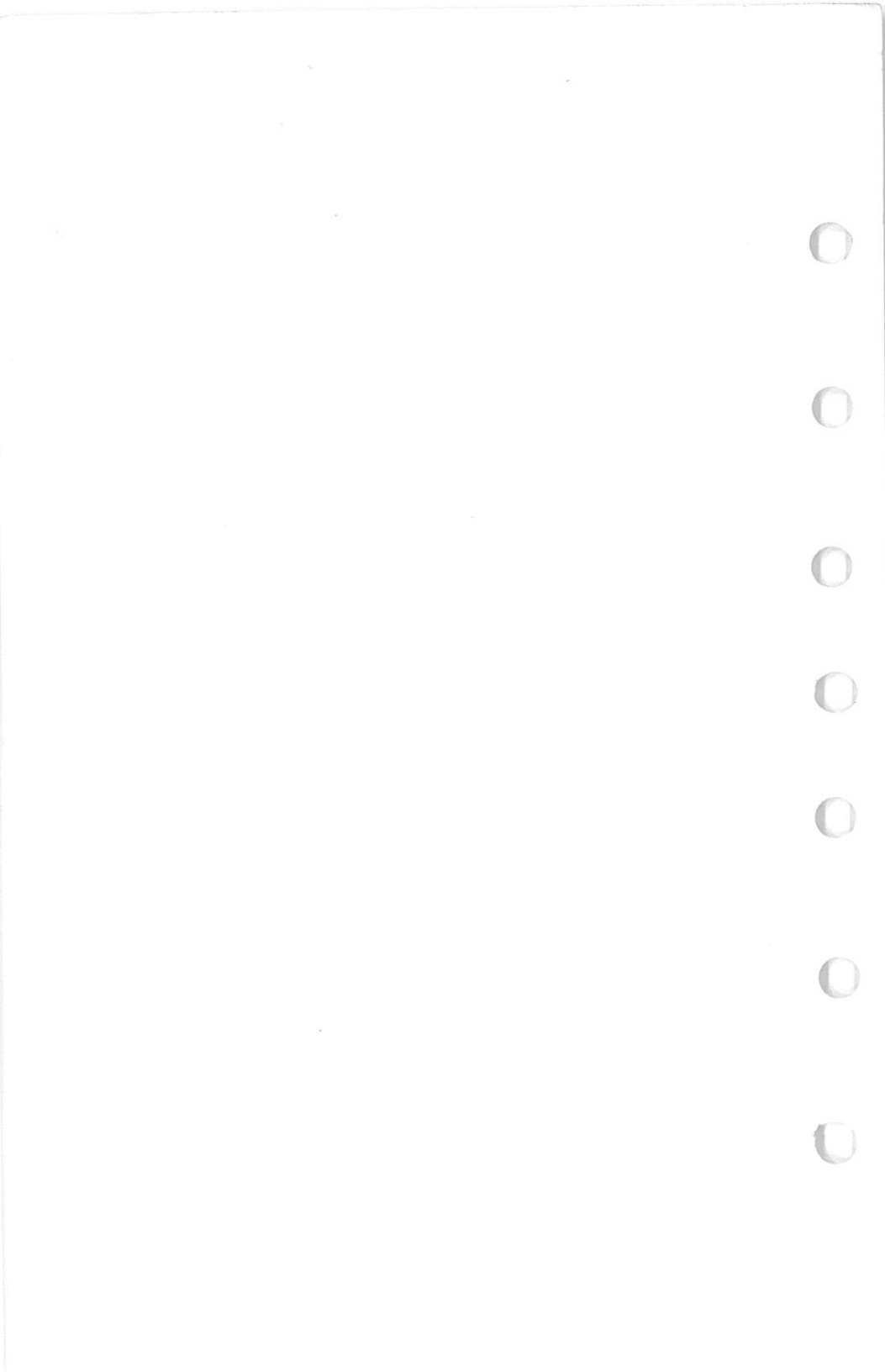

SUPPLEMENT

STROBE LIGHT SYSTEM

SECTION 1 GENERAL

The high intensity strobe light system enhances anti-collision protection for the airplane. The system consists of two wing tip-mounted strobe lights (with integral power supplies), a two-position rocker switch labeled STROBE LT on the left switch and control panel, and a 5-amp push-to-reset circuit breaker, also located on the left switch and control panel.

SECTION 2 LIMITATIONS

Strobe lights must be turned off when taxiing in the vicinity of other airplanes, or during night flight through clouds, fog or haze.

SECTION 3 EMERGENCY PROCEDURES

There is no change to the airplane emergency procedures when strobe lights are installed.

SECTION 4 NORMAL PROCEDURES

To operate the strobe light system, proceed as follows:

1. Master Switch -- ON.
2. Strobe Light Switch -- ON.

SECTION 5

PERFORMANCE

The installation of strobe lights will result in a minor reduction in cruise performance.

SUPPLEMENT

WINTERIZATION KIT

SECTION 1 GENERAL

The winterization kit consists of two cover plates (with placards) which attach to the air intakes in the cowling nose cap, insulation for the engine crankcase breather line, and a placard to be installed on the instrument panel. This equipment should be installed for operations in temperatures consistently below 20°F (-7°C). Once installed, the crankcase breather insulation is approved for permanent use, regardless of temperature.

SECTION 2 LIMITATIONS

The following information must be presented in the form of placards when the airplane is equipped with a winterization kit.

1. On each nose cap cover plate:

REMOVE WHEN
OAT EXCEEDS 20°F

2. On the instrument panel:

WINTERIZATION KIT MUST BE REMOVED
WHEN OUTSIDE AIR TEMPERATURE IS
ABOVE 20°F.

SECTION 3

EMERGENCY PROCEDURES

There is no change to the airplane emergency procedures when the winterization kit is installed.

SECTION 4

NORMAL PROCEDURES

There is no change to the airplane normal procedures when the winterization kit is installed.

SECTION 5

PERFORMANCE

There is no change to the airplane performance when the winterization kit is installed.

SUPPLEMENT

EMERGENCY LOCATOR TRANSMITTER (ELT)

SECTION 1 GENERAL

The ELT consists of a self-contained dual-frequency radio transmitter and battery power supply, and is activated by an impact of 5g or more as may be experienced in a crash landing. The ELT emits an omni-directional signal on the international distress frequencies of 121.5 and 243.0 MHz. (Some ELT units in export aircraft transmit only on 121.5 MHz.) General aviation and commercial aircraft, the FAA, and CAP monitor 121.5 MHz, and 243.0 MHz is monitored by the military. Following a crash landing, the ELT will provide line-of-sight transmission up to 100 miles at 10,000 feet. The ELT supplied in domestic aircraft transmits on both distress frequencies simultaneously at 75 mw rated power output for 50 continuous hours in the temperature range of -4°F to +131°F (-20°C to +55°C). The ELT unit in export aircraft transmits on 121.5 MHz at 25 mw rated power output for 50 continuous hours in the temperature range of -4°F to +131°F (-20°C to +55°C).

The ELT is readily identified as a bright orange unit mounted on the right hand side of the baggage compartment wall in the tailcone. To gain access to the unit, remove the cover. The ELT is operated by a control panel at the forward facing end of the unit (see figure 1).

SECTION 2 LIMITATIONS

The following information must be presented in the form of a placard located on the baggage compartment wall.

EMERGENCY LOCATOR TRANSMITTER
INSTALLED BEHIND THIS COVER.
MUST BE SERVICED IN ACCORDANCE
WITH FAR 91.52

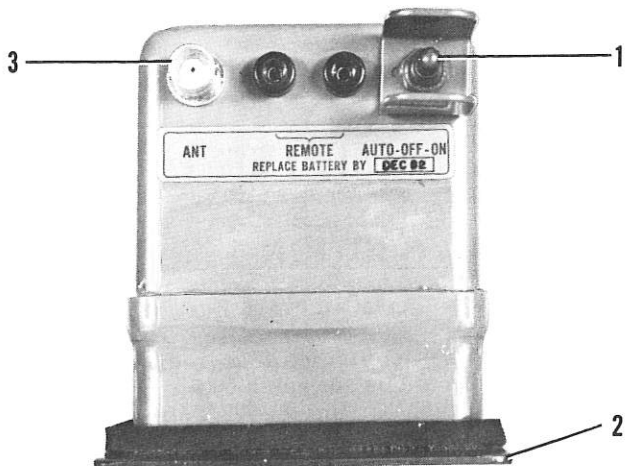

1. FUNCTION SELECTOR SWITCH (3-position toggle switch):
 - ON - Activates transmitter instantly. Used for test purposes and if "g" switch is inoperative.
 - OFF - Deactivates transmitter. Used during shipping, storage and following rescue.
 - AUTO - Activates transmitter only when "g" switch receives 5g or more impact.
2. COVER - Removable for access to battery pack.
3. ANTENNA RECEPTACLE - Connects to antenna mounted on top of tailcone.

Figure 1. ELT Control Panel

SECTION 3

EMERGENCY PROCEDURES

Immediately after a forced landing where emergency assistance is required, the ELT should be utilized as follows.

1. ENSURE ELT ACTIVATION --Turn a radio transceiver ON and select 121.5 MHz. If the ELT can be heard transmitting, it was activated by the "g" switch and is functioning properly. If no emergency tone is audible, gain access to the ELT and place the function selector switch in the ON position.

2. PRIOR TO SIGHTING RESCUE AIRCRAFT -- Conserve airplane battery. Do not activate radio transceiver.
3. ~~AFTER SIGHTING RESCUE AIRCRAFT~~ -- Place ELT function selector switch in the OFF position, preventing radio interference. Attempt contact with rescue aircraft with the radio transceiver set to a frequency of 121.5 MHz. If no contact is established, return the function selector switch to ON immediately.
4. FOLLOWING RESCUE -- Place ELT function selector switch in the OFF position, terminating emergency transmissions.

SECTION 4

NORMAL PROCEDURES

As long as the function selector switch remains in the AUTO position, the ELT automatically activates following an impact of 5g or more over a short period of time.

Following a lightning strike, or an exceptionally hard landing, the ELT may activate although no emergency exists. To check your ELT for inadvertent activation, select 121.5 MHz on your radio transceiver and listen for an emergency tone transmission. If the ELT can be heard transmitting, place the function selector switch in the OFF position and the tone should cease. Immediately place the function selector switch in the AUTO position to re-set the ELT for normal operation.

SECTION 5

PERFORMANCE

There is no change to the airplane performance data when this equipment is installed.

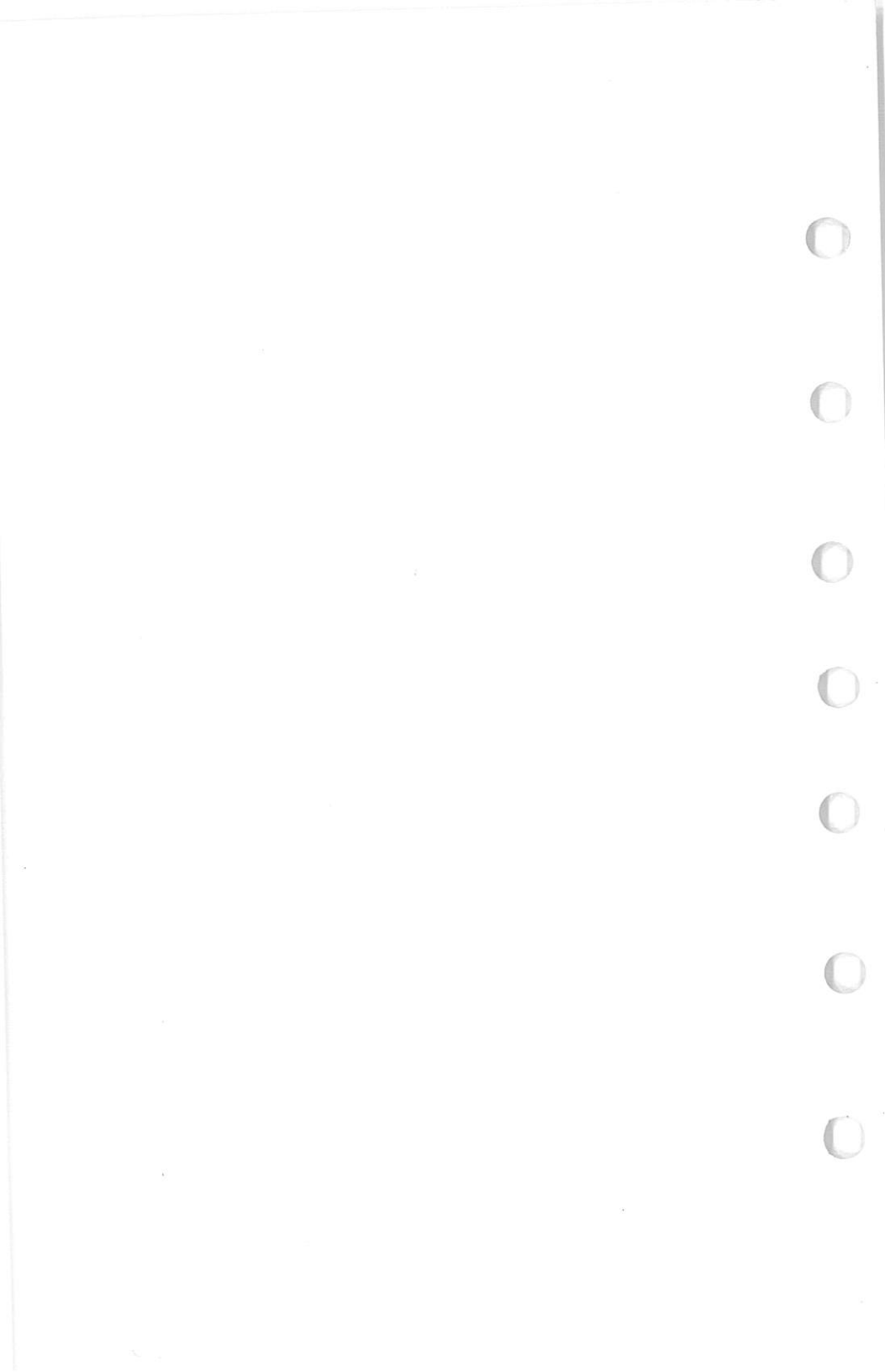

SUPPLEMENT

CESSNA 400 GLIDE SLOPE (Type R-443B)

SECTION 1 GENERAL

The Cessna 400 Glide Slope is an airborne navigation receiver which receives and interprets glide slope signals from a ground-based Instrument Landing System (ILS). It is used with the localizer function of a VHF navigation system when making instrument approaches to an airport. The glide slope provides vertical path guidance while the localizer provides horizontal track guidance.

The Cessna 400 Glide Slope system consists of a remote-mounted receiver coupled to an existing navigation system, a panel-mounted indicator and an externally mounted antenna. The glide slope receiver is designed to receive ILS glide slope signals on any of 40 channels. The channels are spaced 150 kHz apart and cover a frequency range of 329.15 MHz through 335.0 MHz. When a localizer frequency is selected on the NAV receiver, the associated glide slope frequency is selected automatically.

Operation of the Cessna 400 Glide Slope system is controlled by the associated navigation system. The functions and indications of typical 300 series glide slope indicators are pictured and described in Figure 1. The 300 series glide slope indicators shown in Figure 1 depict typical indications for Cessna-crafted glide slope indicators. However, refer to the 400 Nav/Com or HSI write-ups if they are listed in this section as options for additional glide slope indicators.

SECTION 2 LIMITATIONS

There is no change to the airplane limitations when this avionic equipment is installed.

TYPICAL 300 SERIES GLIDE SLOPE INDICATORS

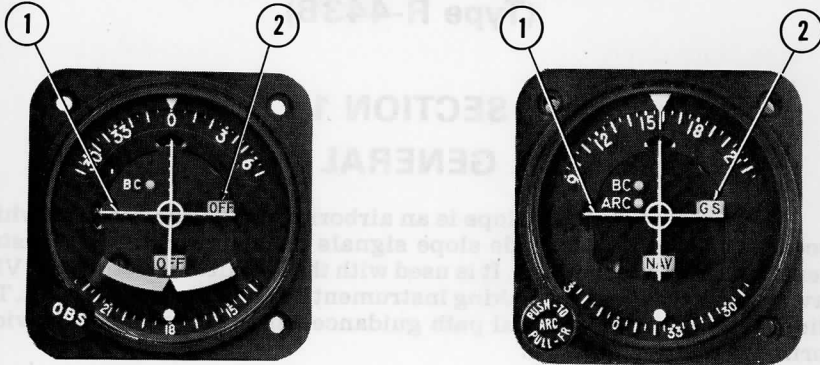

1. GLIDE SLOPE DEVIATION POINTER - Indicates deviation from normal glide slope.
2. GLIDE SLOPE "OFF" OR "GS" FLAG - When visible, indicates unreliable glide slope signal or improperly operating equipment. The flag disappears when a reliable glide slope signal is being received.

CAUTION

Spurious glide slope signals may exist in the area of the localizer back course approach which can cause the glide slope "OFF" or "GS" flag to disappear and present unreliable glide slope information. Disregard all glide slope signal indications when making a localizer back course approach unless a glide slope (ILS BC) is specified on the approach and landing chart.

Figure 1. Typical 300 Series VOR/LOC/ILS Indicator

SECTION 3

EMERGENCY PROCEDURES

There is no change to the airplane emergency procedures when this avionic equipment is installed.

SECTION 4

NORMAL PROCEDURES

TO RECEIVE GLIDE SLOPE SIGNALS:

NOTE

The pilot should be aware that on many Cessna airplanes equipped with the windshield mounted glide slope antenna, pilots should avoid use of 2700 \pm 100 RPM on airplanes equipped with a two-bladed propeller or 1800 \pm 100 RPM on airplanes equipped with a three-bladed propeller during ILS approaches to avoid oscillations of the glide slope deviation pointer caused by propeller interference.

1. NAV Frequency Select Knobs -- SELECT desired localizer frequency (glide slope frequency is automatically selected).
2. NAV/COM VOX-ID-T Switch -- SELECT ID position to disconnect filter from audio circuit.
3. NAV VOL Control -- ADJUST to desired listening level to confirm proper localizer station.

CAUTION

When glide slope "OFF" or "GS" flag is visible, glide slope indications are unusable.

SECTION 5

PERFORMANCE

There is no change to the airplane performance when this avionic equipment is installed.

SUPPLEMENT

CESSNA 400 MARKER BEACON (Type R-402A)

SECTION 1 GENERAL

The system consists of a remote mounted 75 MHz marker beacon receiver, an antenna which is either flush mounted or externally mounted on the under side of the aircraft and operating controls and annunciator lights which are mounted on the front of the audio control panel.

Operating controls for the marker beacon system are supplied on the front of the two types of audio control panels used in this Cessna aircraft. The operating controls for the marker beacon are different on the two audio control panels. One type of audio control panel is supplied with one or two transmitters and the other is supplied with three transmitters.

The marker beacon operating controls and annunciator lights used on the audio control panel supplied with two or less transmitters are shown and described in Figure 1. The operating controls consist of three, three-position toggle switches. One switch is labeled "HIGH/LO/MUTE" and provides the pilot with HIGH-LO sensitivity selection and marker beacon audio muting, for approximately 30 seconds, to enable voice communication to be heard without interference of marker beacon signals. The marker beacon audible tone is automatically restored at the end of the 30 second muting period to continue marker audio for passage over the next marker. Another switch is labeled "SPKR/OFF/PHN" and is used to turn the set on and select the desired speaker or phone position for marker beacon signals. The third toggle switch labeled, "ANN LT", is provided to enable the pilot to select the desired DAY or NITE lighting position for annunciator lights, and also a "TEST" position to verify operation of marker beacon annunciator lights.

The marker beacon operating controls and annunciator lights used on the audio control panel supplied with three transmitters are shown and described in Figure 2. The operating controls consist of two, three-position toggle switches, and two concentric control knobs. One switch is labeled "SPKR/PHN" and is used to select the desired speaker or phone position for marker beacon signals. The other switch is labeled "HI/LO/TEST" and

provides the pilot with HI-LO sensitivity selection and a TEST position to verify operation of all annunciator lights. The small, inner control knob labeled OFF/VOL, turns the set on or off and adjusts the audio listening level. The large, outer control knob labeled BRT, provides light dimming for the marker beacon lights.

When the Cessna 400 Marker Beacon controls are incorporated in an audio control panel incorporated with two or less transmitters a marker Beacon audio level adjustment potentiometer and an annunciator lights minimum dimming potentiometer are mounted on the audio control panel circuit board. Potentiometer adjustments cannot be accomplished externally. However, if readjustments are desired, adjustments can be made in accordance with instructions found in the Avionics Installations Service/Parts Manual for this aircraft.

MARKER FACILITIES

MARKER	IDENTIFYING TONE	LIGHT*
Inner & Fan	Continuous 6 dots/sec (300 Hz)	White
Middle	Alternate dots and dashes (1300 Hz)	Amber
Outer	2 dashes/sec (400 Hz)	Blue

* When the identifying tone is keyed, the respective indicating light will blink accordingly.

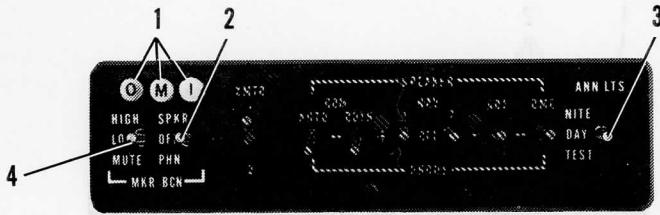

AUDIO CONTROL PANEL FOR USE WITH ONE OR TWO TRANSMITTERS

1. MARKER BEACON ANNUNCIATOR LIGHTS:

OUTER - Light illuminates blue to indicate passage of outer marker beacon.
MIDDLE - Light illuminates amber to indicate passage of middle marker beacon.
INNER and FAN - Light illuminates white to indicate passage of inner and fan marker beacon.

2. SPEAKER/OFF/PHONE SELECTOR SWITCH:

SPEAKER POSITION - Turns set on and selects speaker for aural reception.
OFF POSITION - Turns set off.
PHONE POSITION - Turns set on and selects phone for aural reception.

3. ANNUNCIATOR LIGHTS SWITCH:

NITE POSITION - Places the annunciator lights in a dim lighting mode for night flying operations. Light intensity of the NITE position is controlled by the RADIO LT dimming rheostat.
DAY POSITION - Places the annunciator lights in the full bright position for daylight flying operations.
TEST POSITION - Illuminates all marker beacon annunciator lights (and other annunciators) in the full bright position to verify operation of annunciator lights.

4. HIGH/LO/MUTE SELECTOR SWITCH:

HIGH POSITION - Receiver sensitivity is positioned for airway flying.
LO POSITION - Receiver sensitivity is positioned for ILS approaches.
MUTE POSITION - The marker beacon audio signals are temporarily blanked out (for approximately 30 seconds) and then automatically restored, over the speaker or headset in order to provide voice communications without interference of marker beacon signals.

Figure 1. Cessna 400 Marker Beacon Operating Controls and Indicator Lights Supplied with Two or Less Transmitters

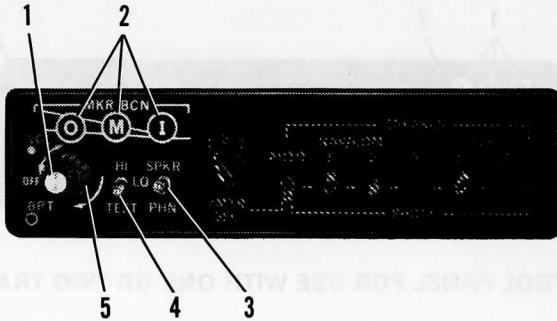

AUDIO CONTROL PANEL FOR USE WITH THREE TRANSMITTERS

1. OFF/VOLUME CONTROL:

OFF/VOL - Turns the set on or off and adjusts the audio listening level. Clockwise rotation of the smaller knob turns the set on and increases the audio level.

2. MARKER BEACON ANNUNCIATOR LIGHTS:

OUTER - Light illuminates blue to indicate passage of outer marker beacon.
MIDDLE - Light illuminates amber to indicate passage of middle marker beacon.
INNER and FAN - Light illuminates white to indicate passage of inner or fan marker beacon.

3. SPEAKER/PHONE SELECTOR SWITCH:

SPEAKER POSITION - Selects speaker for aural reception.
PHONE POSITION - Selects headphone for aural reception.

4. HI/LO/TEST SELECTOR SWITCH:

HI POSITION - Receiver sensitivity is positioned for airway flying.
LO POSITION - Receiver sensitivity is positioned for ILS approaches.
TEST POSITION - Illuminates all annunciator lights in the full bright position to verify operation of annunciator lights.

5. LIGHT DIMMING CONTROL:

BRT - Provides light dimming for the annunciator lights. Clockwise rotation of the larger knob increases light intensity.

Figure 2. Cessna 400 Marker Beacon Operating Controls and Indicator Lights Supplied With Three Transmitters.

SECTION 2 LIMITATIONS

There is no change to the airplane limitations when this avionic equipment is installed.

SECTION 3 EMERGENCY PROCEDURES

There is no change to the airplane emergency procedures when this avionic equipment is installed.

SECTION 4 NORMAL PROCEDURES

MARKER BEACON OPERATING PROCEDURES FOR USE WITH AUDIO CONTROL PANELS PROVIDED WITH ONE OR TWO TRANSMITTERS (REF. FIG. 1)

1. SPKR/OFF/PHN Selector Switch -- SELECT desired speaker or phone audio. Either selected position will turn set on.
2. NITE/DAY/TEST Selector Switch -- PRESS to TEST position and verify that all marker beacon annunciator lights illuminate full bright to indicate lights are operational.
3. NITE/DAY/TEST Selector Switch -- SELECT desired position for NITE or DAY lighting.
4. HIGH/LO/MUTE Selector Switch -- SELECT HI position for airway flying or LO position for ILS approaches.

NOTE

Press MUTE switch to provide an approximate 30 seconds temporary blanking out of Marker Beacon audio tone. The marker beacon audio tone identifier is automatically restored at the end of the muting period.

NOTE

Due to the short distance typical between the middle marker and inner marker, audio identification of the inner marker may not be possible if muting is activated over the middle marker.

MARKER BEACON OPERATING PROCEDURES FOR USE WITH AUDIO CONTROL PANELS PROVIDED WITH THREE TRANSMITTERS. (REF. FIG. 2)

1. OFF/VOL Control -- TURN to VOL position and adjust to desired listening level. Clockwise rotation increases audio level.
2. HI/LO Sen Switch -- SELECT HI position for airway flying or LO position for ILS approaches.
3. SPKR/PHN Switch -- SELECT speaker or phone audio.
4. BRT Control -- SELECT BRT (full clockwise). ADJUST as desired when illuminated over marker beacon.
5. TEST Switch -- PRESS to TEST position and verify that all marker beacon annunciator lights will illuminate full-bright to indicate lights are operational.

SECTION 5

PERFORMANCE

There is no change to the airplane performance when this avionics equipment is installed. However, the installation of an externally mounted antenna or several related external antennas, will result in a minor reduction in cruise performance.

S-TEC CORPORATION
MINERAL WELLS, TEXAS 76067

FAA/DAS APPROVED
PILOT'S OPERATING HANDBOOK AND/OR
AIRPLANE FLIGHT MANUAL SUPPLEMENT
FOR

Cessna models R172E (USAF T-41B, USAF T-41C, and USAF T-41D),
R172F (USAF T-41D), R172G (USAF T-41C or USAF T-41D),
R172H (USAF T-41D), and R172K

WITH
S-TEC SYSTEM 30 TWO AXIS
AUTOMATIC FLIGHT GUIDANCE SYSTEM
(28 Volt System)

REG. NO. N758RL

SER. NO. R1723299

This Supplement must be attached to the applicable FAA Approved Airplane Flight Manual, Pilot's Operating Handbook, or Pilot's Operating Handbook and FAA Approved Airplane Flight Manual modified by the installation of S-TEC System 30 Autopilot Model ST-671-30 installed in accordance with STC SA09209AC-D. The information contained herein supplements or supersedes the basic manual. For limitations, procedures and performance information not contained in this supplement, consult the basic Pilot's Operating Handbook and/or Airplane Flight Manual.

SECTION I

GENERAL

This manual is to acquaint the pilot with the features and functions of the System 30 Two Axis Autopilot and to provide operating instructions for the system when installed in the listed aircraft model(s). The aircraft must be operated within the limitations herein provided when the autopilot is in use.

FAA/DAS APPROVED



Walter F. Davis

S-TEC CORPORATION
DAS 5 SW
/N: 891363✓
/TE: 5-12-97

S-TEC CORPORATION
MINERAL WELLS, TEXAS 76067

FAA/DAS APPROVED
PILOT'S OPERATING HANDBOOK AND/OR
AIRPLANE FLIGHT MANUAL SUPPLEMENT
FOR

Cessna models R172E (USAF T-41B, USAF T-41C, and USAF T-41D),
R172F (USAF T-41D), R172G (USAF T-41C or USAF T-41D),
R172H (USAF T-41D), and R172K

LOG OF REVISIONS

REV. NO.	PAGES AFFECTED	DESCRIPTION	APPROVED	DATE
1	All	Added models R172E (USAF T-41B, USAF T-41C, and USAF T-41D), R172F (USAF T-41D), R172G (USAF T-41C or USAF T-41D), and R172H (USAF T-41D).	<i>WFO</i>	8-27-99

FAA/DAS APPROVED
P/N: 891363
ATE: 5-12-97

FAA/DAS APPROVED
PILOT'S OPERATING HANDBOOK AND/OR
AIRPLANE FLIGHT MANUAL SUPPLEMENT
FOR

Cessna models R172E (USAF T-41B, USAF T-41C, and USAF T-41D),
R172F (USAF T-41D), R172G (USAF T-41C or USAF T-41D), and R172H
R172H (USAF T-41D), and R172K

.....

SECTION II

OPERATING LIMITATIONS

1. For models R172E (USAF T-41B, USAF T-41C, and USAF T-41D), R172F (USAF T-41D), R172G (USAF T-41C or USAF T-41D), and R172H (USAF T-41D): Autopilot operation prohibited above 155 MPH CAS.

For model R172K: Autopilot operation prohibited above 140 KIAS.

SECTION III

EMERGENCY OPERATING PROCEDURES

In the event of an autopilot malfunction, or any time the autopilot is not performing as expected or commanded, do not attempt to identify the system problem. Immediately regain control of the aircraft by overpowering the autopilot as necessary and then disconnect the autopilot. Do not reengage the autopilot until the problem has been identified and corrected.

1. Autopilot may be disconnected by:
 - a. Depressing the "AP Disconnect" Switch on the left horn of the pilot's control wheel (if installed).
 - b. Press and hold the mode selector knob for approximately 2 seconds.
 - c. Moving the autopilot master switch to "OFF" position.
 - d. Pulling the autopilot circuit breaker.

2. Altitude loss during a malfunction and recovery.

- a. The following altitude losses and bank angles were recorded after a malfunction with a 3 second recovery delay:

<u>Configuration</u>	<u>Bank Angle/Altitude Loss</u>
Climb	45°/-20'
Cruise	55°/-300'
Descent	45°/-375'

- b. The following altitude losses and bank angles were recorded after a malfunction with a 1 second recovery delay:

<u>Configuration</u>	<u>Bank Angle/Altitude Loss</u>
Maneuvering	18°/-100'
Approach (coupled or uncoupled)	20°/-20'

FAA/DAS APPROVED
P/N: 891363
DATE: 5-12-97

Cessna models R172E (USAF T-41B, USAF T-41C, and USAF T-41D),
R172F (USAF T-41D), R172G (USAF T-41C or USAF T-41D),
R172H (USAF T-41D), and R172K

.....

The above values are the worst case for all the models covered by this document.

SECTION IV

NORMAL OPERATING PROCEDURES

4-1 SYSTEM DESCRIPTION

The System 30 is a pure rate autopilot which uses an inclined rate gyro in the Turn Coordinator instrument as the primary roll and turn rate sensor and an accelerometer and an absolute pressure transducer as pitch rate sensors. The turn coordinator includes an autopilot pick-off, a gyro RPM detector and an instrument power monitor. Low electrical power will cause the instrument "flag" to appear while low RPM will cause the autopilot to disconnect. The autopilot includes an automatic pre-flight test feature that allows a visual check of all the annunciator lamps and checks critical elements of the accelerometer system. The test feature will not enable autopilot function unless the automatic test sequence is satisfactorily completed.

When the pre-flight test is satisfactorily completed and when the rate gyro RPM is correct, the green "RDY" light will illuminate indicating the autopilot is ready for the functional check and operation. The autopilot cannot be engaged unless the "RDY" light is illuminated. When the system is equipped with the optional 3" Air Driven Directional Gyro (D.G.) or a compass system, directional information is provided to the autopilot by a heading bug in the instrument.

Pitch axis control is provided for the altitude hold function by use of the accelerometer and the pressure transducer. When the altitude hold mode is engaged an elevator trim sensor in the pitch servo will detect the elevator trim condition. When elevator trim is necessary to re-establish a trimmed condition, trim indicator lights on the programmer unit will illuminate to indicate the direction to trim to restore a trimmed condition.

If the pilot ignores a trim light for more than five seconds the light will begin to flash to get the pilot's attention.

The indicator and annunciator lamp brilliance is controlled through the aircraft instrument light rheostat, except for the "trim" indicators which always illuminate at full intensity.

FRA/DAS APPROVED

P/N: 891363

DATE: 5-12-97

S-TEC CORPORATION
MINERAL WELLS, TEXAS 76067

FAA/DAS APPROVED
PILOT'S OPERATING HANDBOOK AND/OR
AIRPLANE FLIGHT MANUAL SUPPLEMENT
FOR

Cessna models R172E (USAF T-41B, USAF T-41C, and USAF T-41D),
R172F (USAF T-41D), R172G (USAF T-41C or USAF T-41D),
R172H (USAF T-41D), and R172K

.....

For detailed normal operating procedures, including system description, pre-flight and inflight procedures refer to S-TEC Pilot's Operating Handbook P/N 8777, dated 2-02-99, or later.

SECTION V

PERFORMANCE

Text of this Section not affected by installation of this equipment.

SECTION VI

WEIGHT AND BALANCE

Text of this Section not affected by installation of this equipment.

SECTION VII

DESCRIPTION AND OPERATION OF THE AIRPLANE AND ITS SYSTEMS

Text of this Section not affected by installation of this equipment.

SECTION VIII

AIRPLANE HANDLING, SERVICING AND MAINTENANCE

Text of this Section not affected by installation of this equipment.

SECTION IX

SUPPLEMENTS

Refer to contents of this supplement for operation of System 30 Automatic Flight Control System.

SECTION X

OPERATING TIPS

Text of this Section not affected by installation of this equipment.

FAA/DAS APPROVED
P/N: 891363
DATE: 5-12-97



Twenty | Thirty | Thirty Alt

Pilot's Operating Handbook



Page Intentionally Blank

Table of Contents

Sec.		Pg.
1	Overview.....	1-1
	1.1 Document Organization.....	1-3
	1.2 Purpose.....	1-3
	1.3 General Control Theory.....	1-3
	1.4 Modes of Operation.....	1-4
	1.4.1 Roll Axis Control.....	1-4
	1.4.2 Pitch Axis Control.....	1-4
	1.5 Block Diagrams.....	1-4
2	Pre-Flight Procedures.....	2-1
	2.1 Power-Up Test.....	2-3
	2.1.1 System Twenty.....	2-3
	2.1.2 System Thirty.....	2-7
	2.1.3 System Thirty ALT.....	2-13
	2.2 Pre-Flight Test.....	2-17
	2.2.1 System Twenty.....	2-17
	2.2.2 System Thirty.....	2-25
	2.2.3 System Thirty ALT.....	2-35
3	In-Flight Procedures.....	3-1
	3.1 Normal Operating Procedures.....	3-3
	3.1.1 Stabilizer (ST) Mode, System Twenty / Thirty.....	3-3
	3.1.2 Heading (HD) Mode, System Twenty / Thirty.....	3-4
	3.1.3 Low Track (LO TRK) Mode, System Twenty / Thirty.....	3-5

- 3.1.4 High Track (HI TRK) Mode, System Twenty / Thirty.....3-6
 - 3.1.4.1 LOC Course Tracking.....3-6
 - 3.1.4.2 GPS Course Tracking.....3-6
 - 3.1.4.3 VOR Course Tracking.....3-6
- 3.1.5 Altitude Hold (ALT HOLD) Mode, System Thirty / Thirty ALT.....3-7
 - 3.1.5.1 System Thirty.....3-7
 - 3.1.5.2 System Thirty ALT.....3-8
- 3.1.6 Manual Elevator Trim Prompts, System Thirty / Thirty ALT.....3-8
 - 3.1.6.1 System Thirty.....3-8
 - 3.1.6.2 System Thirty ALT.....3-8
- 3.2 Approach Procedures.....3-11
 - 3.2.1 Straight-In LOC Approach.....3-11
 - 3.2.1.1 Heading System DG.....3-11
 - 3.2.1.2 Heading System HSI.....3-11
 - 3.2.2 Straight-In VOR Approach.....3-11
 - 3.2.2.1 Heading System DG.....3-11
 - 3.2.2.2 Heading System HSI.....3-11
 - 3.2.3 LOC Approach with Procedure Turn.....3-16
 - 3.2.3.1 Heading System DG.....3-16
 - 3.2.3.2 Heading System HSI.....3-16
 - 3.2.4 VOR Approach with Procedure Turn.....3-19
 - 3.2.4.1 Heading System DG.....3-19
 - 3.2.4.2 Heading System HSI.....3-19

3.3	Yaw Damper Operation.....	3-22
3.3.1	AUTO Mode.....	3-22
3.3.2	ON Mode.....	3-22
3.3.3	Yaw Damper Trim.....	3-22
3.4	Autopilot Disconnect	3-23
3.4.1	System Twenty / Thirty.....	3-23
3.4.2	System Thirty ALT.....	3-23
4	Operating Parameters.....	4-1
4.1	Roll Axis Limits.....	4-3
4.2	Pitch Axis Limits.....	4-3
5	Glossary.....	5-1

List of Figures

Fig.		Pg.
1-1	System Twenty Block Diagram.....	1-5
1-2	System Thirty Block Diagram.....	1-6
1-3	System Thirty ALT Block Diagram.....	1-7
1-4	Yaw Damper Block Diagram.....	1-8
2-1	AP Display, Lamps Illuminated at Power-Up (System Twenty).....	2-4
2-2	AP Display, All Lamps Extinguished (System Twenty).....	2-4
2-3	AP Display, RDY for Operation.....	2-5
2-4	AP Display, Turn Coordinator Failure (System Twenty).....	2-5
2-5	AP Display, Low Voltage Flag (System Twenty).....	2-6
2-6	AP Display, Lamps Illuminated at Power-Up (System Thirty).....	2-8
2-7	AP Display, TRIM UP Lamp Extinguished (System Thirty).....	2-8
2-8	AP Display, ALT Lamp Only Illuminated (System Thirty).....	2-9
2-9	AP Display, All Lamps Extinguished (System Thirty).....	2-9
2-10	AP Display, RDY for Operation (System Thirty).....	2-10
2-11	AP Display, Turn Coordinator Failure (System Thirty).....	2-10
2-12	AP Display, Low Voltage Flag (System Thirty).....	2-11
2-13	ALT HOLD ON/OFF Switch Display, Lamps Illuminated at Power-Up (System Thirty ALT).....	2-14
2-14	ALT HOLD ON/OFF Switch Display, UP Lamp Extinguished (System Thirty ALT).....	2-14
2-15	ALT HOLD ON/OFF Switch Display, DN Lamp Extinguished (System Thirty ALT).....	2-15
2-16	ALT HOLD ON/OFF Switch Display, ALT ON Lamp Extinguished (System Thirty ALT).....	2-15
2-17	AP Display, ST Mode Engaged (System Twenty).....	2-19
2-18	AP Display, HD Mode Engaged (System Twenty).....	2-19
2-19	AP Display, LO TRK Mode Engaged (System Twenty).....	2-21

2-20	AP Display, HI TRK Mode Engaged (System Twenty).....	2-21
2-21	AP Display, ST Mode Engaged (System Thirty).....	2-27
2-22	AP Display, HD Mode Engaged (System Thirty).....	2-27
2-23	AP Display, LO TRK Mode Engaged (System Thirty).....	2-29
2-24	AP Display, LO TRK Mode Engaged (System Thirty).....	2-29
2-25	AP Display, HI TRK and ALT HOLD Modes Engaged (System Thirty).....	2-31
2-26	AP Display, HI TRK and ALT HOLD ModeS Engaged, TRIM UP Required (System Thirty).....	2-32
2-27	AP Display, HI TRK and ALT HOLD ModeS Engaged, TRIM DN Required (System Thirty).....	2-32
2-28	ALT HOLD ON/OFF Switch Display, ALT HOLD Mode Engaged (System Thirty ALT).....	2-36
2-29	ALT HOLD ON/OFF Switch Display, ALT HOLD Mode Engaged, TRIM UP Required (System Thirty ALT).....	2-36
2-30	ALT HOLD ON/OFF Switch Display, ALT HOLD Mode Engaged, TRIM DN Required (System Thirty ALT).....	2-36
3-1	AP Display, ST Mode Engaged.....	3-3
3-2	AP Display, HD Mode Engaged.....	3-4
3-3	AP Display, LO TRK Mode Engaged.....	3-5
3-4	AP Display, HI TRK Mode Engaged.....	3-6
3-5	AP Display, ST and ALT HOLD Modes Engaged (System Thirty).....	3-7
3-6	ALT HOLD ON/OFF Switch Display, ALT HOLD Mode Engaged (System Thirty ALT).....	3-8
3-7	AP Display, Manual Trim Prompts (System Thirty).....	3-9
3-8	AP Display, Manual Trim Prompts (System Thirty ALT).....	3-10
3-9	Straight-In LOC Approach (DG).....	3-12
3-10	Straight-In LOC Approach (HSI).....	3-13
3-11	Straight-In VOR Approach (DG).....	3-14
3-12	Straight-In VOR Approach (HSI).....	3-15
3-13	LOC Approach with Procedure Turn (DG).....	3-17

S-TEC

3-14 LOC Approach with Procedure Turn (HSI).....3-18

3-15 VOR Approach with Procedure Turn (DG).....3-20

3-16 VOR Approach with Procedure Turn (HSI).....3-21

3-17 Yaw Damper Master Switch.....3-22

3-18 Yaw Damper Trim Knob.....3-22

List of Tables

Table	Pg.
2-1 Power-Up Test, System Twenty.....	2-3
2-2 Power-Up Test, System Thirty.....	2-7
2-3 Power-Up Test, System Thirty ALT.....	2-13
2-4 Pre-Flight Test, System Twenty.....	2-17
2-5 Pre-Flight Test, System Thirty.....	2-25
2-6 Pre-Flight Test, System Thirty ALT.....	2-35

SECTION 1 OVERVIEW

Page Intentionally Blank

1.1 Document Organization

Section 1 Overview

Section 2 Pre-Flight Procedures

Section 3 In-Flight Procedures

Section 4 Operating Parameters

Section 5 Glossary

1.2 Purpose

This Pilot's Operating Handbook (POH) provides Pre-Flight and In-Flight operating procedures for the S-TEC System Twenty / Thirty / Thirty ALT Autopilot (AP).

Note:

This POH must be carried in the aircraft and made available to the pilot at all times. It can only be used in conjunction with the Federal Aviation Administration (FAA) approved Aircraft Flight Manual (AFM) or Aircraft Flight Manual Supplement (AFMS). Refer to the applicable AFM or AFMS for aircraft specific information, such as unique ground tests, limitations, and emergency procedures.

Note:

The System Twenty / Thirty / Thirty ALT autopilot is a tool provided to aircraft owners, that serves to assist them with cockpit workload management. The ability of the autopilot to provide optimum assistance and performance is directly proportional to the pilot's knowledge of its operating procedures. Therefore, it is highly recommended that the pilot develop a thorough understanding of the autopilot, its modes, and operating procedures in Visual Meteorological Conditions (VMC), prior to using it under Instrument Flight Rules (IFR).

1.3 General Control Theory

The System Twenty / Thirty / Thirty ALT is a rate based autopilot. When in control of the roll axis, the autopilot senses turn rate, along with the non-rate quantities of heading error and course deviation indication. When in control of the pitch axis, the autopilot senses acceleration, along with the non-rate quantity of altitude. These sensed data provide feedback to the autopilot, which processes them in order to control the aircraft through the use of mechanisms coupled to the control system. The roll servo is typically coupled to the ailerons, and the pitch servo is coupled to the elevator.

The System Twenty controls only the roll axis.

The System Thirty controls both the roll axis and pitch axis. Activation of roll axis control must always precede activation of pitch axis control.

The System Thirty ALT controls only the pitch axis.

S-TEC

The optional Yaw Damper senses excessive adverse yaw about the yaw axis, and responds by driving the yaw servo in the proper direction to provide damping. The yaw servo is coupled to the rudder.

1.4 Modes of Operation

1.4.1 Roll Axis Control

Each press/release of the optional MODE SEL Switch typically located on the Control Wheel, or PUSH MODE Switch located on the bezel, successively engages the roll modes below.

Stabilizer (ST) Mode

Used to Hold Wings Level

Heading (HD) Mode

Used to Turn onto a Selected Heading and Hold it

Low Track (LO TRK) Mode

Used to Track a VOR Course

High Track (HI TRK) Mode

Used to Track a LOC Course

Note:

A heading system (HSI or DG) is optional. If the aircraft is equipped with a heading system, then the heading mode can be engaged. Otherwise, the heading mode cannot be engaged (i.e., it will be skipped over).

1.4.2 Pitch Axis Control

Each press of the ALT ENG/DSNG Switch typically located on the Control Wheel (optional for System Thirty ALT only), or ALT HOLD ON/OFF Switch located on the instrument panel (System Thirty ALT only), successively engages and disengages the single pitch mode below.

Altitude Hold (ALT HOLD) Mode

Used to Hold Altitude

1.5 Block Diagrams

The System Twenty Block Diagram is shown in Fig. 1-1.

The System Thirty Block Diagram is shown in Fig. 1-2.

The System Thirty ALT Block Diagram is shown in Fig. 1-3.

The Yaw Damper Block Diagram is shown in Fig. 1-4.

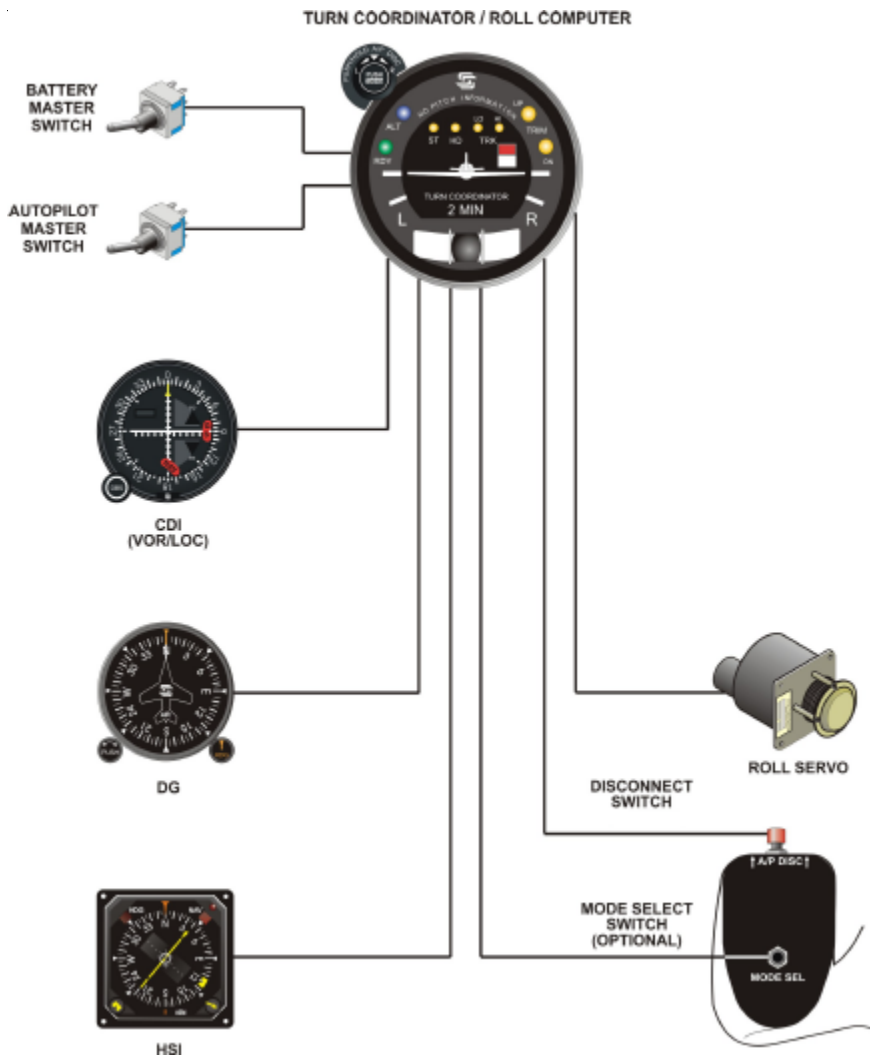

Fig. 1-1. System Twenty Block Diagram

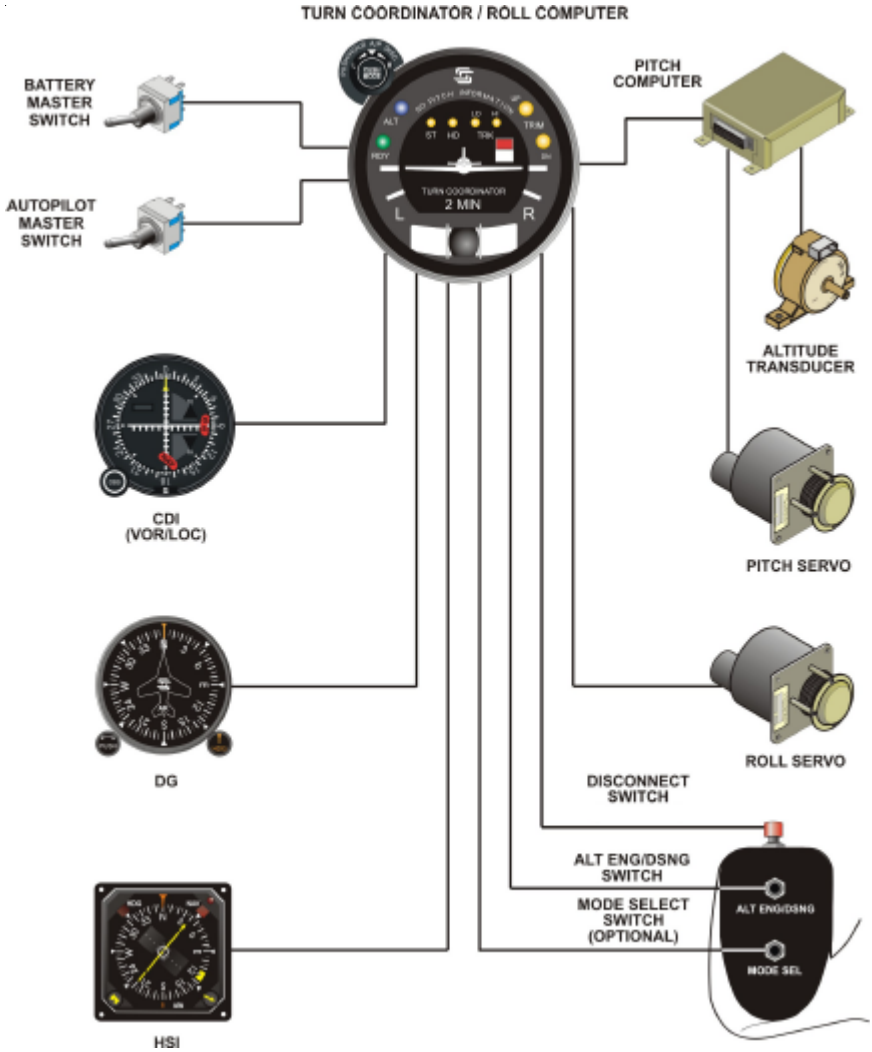

Fig. 1-2. System Thirty Block Diagram

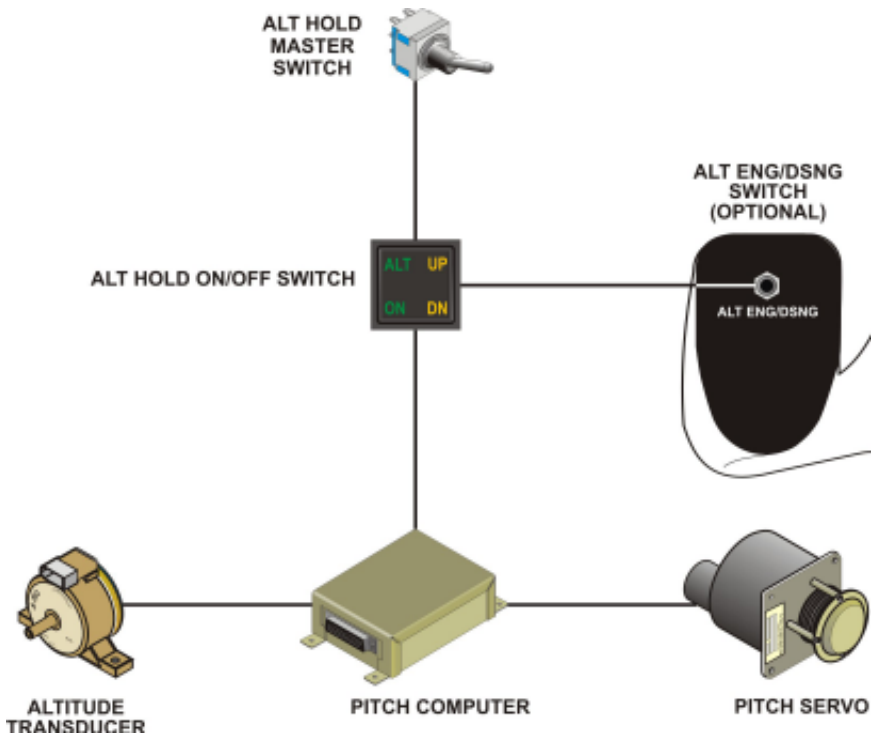

Fig. 1-3. System Thirty ALT Block Diagram

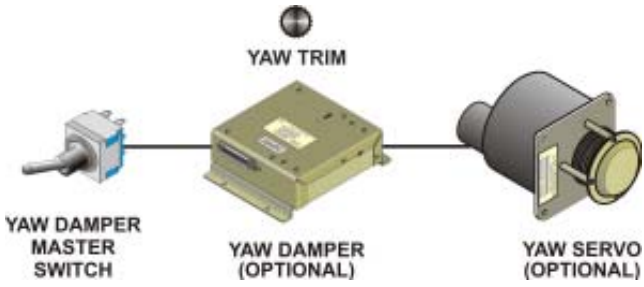

Fig. 1-4. Yaw Damper Block Diagram

SECTION 2 PRE-FLIGHT PROCEDURES

Page Intentionally Blank

2.1 Power-Up Test

2.1.1 System Twenty

Perform the actions shown in Table 2-1. For each action, verify the corresponding response where applicable.

Table 2-1. Power-Up Test, System Twenty

ACTION	RESPONSE
1. Set Yaw Damper Master Switch to OFF position (if installed).	-----
2. Set Battery Master Switch to ON position.	-----
3. Set Avionics Master Switch to ON position.	-----
4. Set Autopilot Master Switch to ON position.	<p>RDY, ST, HD, LO TRK, and HI TRK lamps illuminate on AP display as shown in Fig. 2-1 for 7 seconds, and then extinguish as shown in Fig. 2-2.</p> <p>RDY lamp alone re-illuminates on AP display within 3 minutes, as shown in Fig. 2-3 (Note 1).</p>

Notes:

1. *Should a Turn Coordinator failure be detected, the RDY lamp on the AP display will not re-illuminate as shown in Fig. 2-4, and the autopilot will not operate.*

2. *Should T&B A+ be 30% below its rated value, the Low Voltage Flag will be in view on the AP display as shown in Fig. 2-5.*



Fig. 2-1. AP Display, RDY, ST, HD, LO TRK, HI TRK Lamps Illuminated at Power-Up (System Twenty)



Fig. 2-2. AP Display, All Lamps Extinguished (System Twenty)



Fig. 2-3. AP Display, RDY for Operation (System Twenty)



Fig. 2-4. AP Display, Turn Coordinator Failure (System Twenty)



Fig. 2-5. AP Display, Low Voltage Flag (System Twenty)

2.1.2 System Thirty

Perform the actions shown in Table 2-2. For each action, verify the corresponding response where applicable.

Table 2-2. Power-Up Test, System Thirty

ACTION	RESPONSE
1. Set Yaw Damper Master Switch to OFF position (if installed).	-----
2. Set Battery Master Switch to ON position.	-----
3. Set Avionics Master Switch to ON position.	-----
4. Set Autopilot Master Switch to ON position.	<p>RDY, ALT, ST, HD, LO TRK, HI TRK, TRIM UP, and TRIM DN lamps illuminate on AP display as shown in Fig. 2-6.</p> <p>TRIM UP lamp extinguishes after 2 seconds, as shown in Fig. 2-7.</p> <p>RDY, ST, HD, LO TRK, HI TRK, and TRIM DN lamps extinguish after 7 seconds, as shown in Fig. 2-8.</p> <p>ALT lamp extinguishes after 10 seconds, as shown in Fig. 2-9.</p> <p>RDY lamp alone re-illuminates on AP display within 3 minutes, as shown in Fig. 2-10 (<i>Note 1</i>).</p>

Notes:

1. Should a Turn Coordinator failure be detected, the RDY lamp on the AP display will not re-illuminate as shown in Fig. 2-11, and the autopilot will not operate.

2. Should T&B A+ be 30% below its rated value, the Low Voltage Flag will be in view on the AP display as shown in Fig. 2-12.



Fig. 2-6. AP Display, RDY, ALT, ST, HD, LO TRK, HI TRK, TRIM UP, TRIM DN Lamps Illuminated at Power-Up (System Thirty)



Fig. 2-7. AP Display, TRIM UP Lamp Extinguished (System Thirty)



Fig. 2-8. AP Display, ALT Lamp Only Illuminated (System Thirty)



Fig. 2-9. AP Display, All Lamps Extinguished (System Thirty)



Fig. 2-10. AP Display, RDY for Operation (System Thirty)



Fig. 2-11. AP Display, Turn Coordinator Failure (System Thirty)



**Fig. 2-12. AP Display, Low Voltage Flag
(System Thirty)**

Page Intentionally Blank

2.1.3 System Thirty ALT

Perform the actions shown in Table 2-3. For each action, verify the corresponding response where applicable.

Table 2-3. Power-Up Test, System Thirty ALT

ACTION	RESPONSE
1. Set Yaw Damper Master Switch to OFF position (if installed).	-----
2. Set Battery Master Switch to ON position.	-----
3. Set Avionics Master Switch to ON position.	-----
4. Set ALT HOLD Master Switch to ON position.	<p>ALT ON, UP, and DN lamps illuminate on ALT HOLD ON/OFF Switch display, as shown in Fig. 2-13.</p> <p>UP lamp extinguishes after 2 seconds, as shown in Fig. 2-14.</p> <p>DN lamp extinguishes after 7 seconds, as shown in Fig. 2-15.</p> <p>ALT ON lamp extinguishes after 10 seconds, as shown in Fig. 2-16.</p>



Fig. 2-13. ALT HOLD ON/OFF Switch Display, ALT ON, UP, and DN Lamps Illuminated at Power-Up (System Thirty ALT)



Fig. 2-14. ALT HOLD ON/OFF Switch Display, UP Lamp Extinguished (System Thirty ALT)



**Fig. 2-15. ALT HOLD ON/OFF Switch Display, DN Lamp Extinguished
(System Thirty ALT)**



**Fig. 2-16. ALT HOLD ON/OFF Switch Display, ALT ON Lamp Extinguished
(System Thirty ALT)**

Page Intentionally Blank

2.2 Pre-Flight Test

2.2.1 System Twenty

Prior to takeoff and with engine running, perform the actions shown in Table 2-4. For each action, verify the corresponding response where applicable.

Table 2-4. Pre-Flight Test, System Twenty (continued on page 2-18)

ACTION	RESPONSE
1. Move A/C Control Wheel left and right, to sense its freedom of movement about roll axis.	-----
2. Set L/R Turn Knob located on bezel under its index.	-----
3. Engage stabilizer mode.	ST lamp alone is illuminated on AP display, as shown in Fig. 2-17.
4. Attempt movement of A/C Control Wheel left and right.	A/C Control Wheel's reduced freedom of movement indicates that Roll Servo is engaged. Roll Servo can be overridden. If not, disconnect autopilot and do not use.
5. Turn L/R Turn Knob to the left side of its index.	A/C Control Wheel turns to the left.
6. Turn L/R Turn Knob to the right side of its index.	A/C Control Wheel turns to the right.
7. Set L/R Turn Knob under its index.	A/C Control Wheel stops.
<p style="text-align: center;"><i>Note:</i></p> <p><i>If A/C is equipped with a heading system (HSI or DG), then proceed to step 8.</i></p> <p><i>If A/C is not equipped with a heading system, then proceed to step 13 only if a VOR frequency can be selected. Otherwise, proceed to step 26.</i></p>	

Table 2-4. Pre-Flight Test, System Twenty (continued from page 2-17)

ACTION	RESPONSE
8. Set Heading Bug under Lubber Line.	-----
9. Engage heading mode.	HD lamp alone is illuminated on AP display, as shown in Fig. 2-18.
10. Turn Heading Bug to the left side of Lubber Line.	A/C Control Wheel turns to the left.
11. Turn Heading Bug to the right side of Lubber Line.	A/C Control Wheel turns to the right.
12. Set Heading Bug under Lubber Line.	A/C Control Wheel stops.
<i>Note: If it is not possible to select a local VOR frequency on Navigation Receiver, then proceed to step 26. Otherwise, proceed to step 13.</i>	
13. Select local VOR frequency on Navigation Receiver.	-----
<i>Note: Proceed to either step 14 (HSI) or step 20 (DG).</i>	
14. Turn Course Pointer until CDI needle is centered.	-----
15. Engage low track mode.	LO TRK lamp alone is illuminated on AP display, as shown in Fig. 2-19.
16. Engage high track mode.	HI TRK lamp alone is illuminated on AP display, as shown in Fig. 2-20.
17. Turn Course Pointer left until CDI needle deflection is 2 dots right of center.	A/C Control Wheel turns to the right.



Fig. 2-17. AP Display, ST Mode Engaged (System Twenty)



Fig. 2-18. AP Display, HD Mode Engaged (System Twenty)

Table 2-4. Pre-Flight Test, System Twenty (continued from page 2-18)

ACTION	RESPONSE
18. Turn Course Pointer right until CDI needle deflection is 2 dots left of center.	A/C Control Wheel turns to the left.
19. Turn Course Pointer left until CDI needle is centered.	A/C Control Wheel stops.
<i>Note: Proceed to step 28.</i>	
20. Turn OBS until CDI needle is centered.	-----
21. Engage low track mode.	LO TRK lamp alone is illuminated on AP display, as shown in Fig. 2-19.
22. Engage high track mode.	HI TRK lamp alone is illuminated on AP display, as shown in Fig. 2-20.
23. Turn OBS until CDI needle deflection is 2 dots right of center.	A/C Control Wheel turns to the right.
24. Turn OBS until CDI needle deflection is 2 dots left of center.	A/C Control Wheel turns to the left.
25. Turn OBS until CDI needle is centered.	A/C Control Wheel stops.
<i>Note: Proceed to step 28.</i>	
26. Engage low track mode.	LO TRK lamp alone is illuminated on AP display, as shown in Fig. 2-19.
27. Engage high track mode.	HI TRK lamp alone is illuminated on AP display, as shown in Fig. 2-20.



Fig. 2-19. AP Display, LO TRK Mode Engaged (System Twenty)



Fig. 2-20. AP Display, HI TRK Mode Engaged (System Twenty)

Table 2-4. Pre-Flight Test, System Twenty (continued from page 2-20)

ACTION	RESPONSE
<p>28. Disconnect autopilot by any one of the following means:</p> <p>a. Press optional AP DISC Switch typically located on Control Wheel.</p> <p>b. Press/Hold optional MODE SEL Switch typically located on Control Wheel for 3 seconds.</p> <p>c. Press/Hold PUSH MODE Switch located on bezel for 3 seconds.</p>	<p>RDY lamp flashes and audible alert sounds a periodic tone, while all other lamps are extinguished.</p> <p>After 5 seconds, RDY lamp stops flashing but remains illuminated, and audible alert is squelched.</p>
<p>29. Move A/C Control Wheel left and right.</p>	<p>A/C Control Wheel's increased freedom of movement indicates that Roll Servo is disengaged.</p>
<p><i>Note: If a Yaw Damper is installed, then proceed to step 30. Otherwise, proceed to step 39.</i></p>	
<p>30. Actuate A/C Rudder Pedals alternately in succession, to sense their freedom of movement about yaw axis.</p>	<p>-----</p>
<p>31. Set Yaw Damper Master Switch to ON position.</p>	<p>-----</p>
<p>32. Turn Yaw Trim Knob until A/C Rudder Pedals stop.</p>	<p>-----</p>
<p>33. Attempt actuation of A/C Rudder Pedals alternately in succession.</p>	<p>A/C Rudder Pedals' reduced freedom of movement indicates that Yaw Servo is engaged.</p> <p>Yaw Servo can be overridden. If not, set Yaw Damper Master Switch to OFF position, and do not use.</p>

Table 2-4. Pre-Flight Test, System Twenty (continued from page 2-22)

ACTION	RESPONSE
34. Turn Yaw Trim Knob fully CCW.	Left A/C Rudder Pedal slowly moves forward.
35. Turn Yaw Trim Knob fully CW.	Right A/C Rudder Pedal slowly moves forward.
36. Turn Yaw Trim Knob CCW until A/C Rudder Pedals stop.	-----
37. Set Yaw Damper Master Switch to OFF position.	-----
38. Actuate A/C Rudder Pedals alternately in succession.	A/C Rudder Pedals' increased freedom of movement indicates that Yaw Servo is disengaged.
39. Trim A/C for takeoff.	-----

Page Intentionally Blank

2.2.2 System Thirty

Prior to takeoff and with engine running, perform the actions shown in Table 2-5. For each action, verify the corresponding response where applicable.

Table 2-5. Pre-Flight Test, System Thirty (continued on page 2-26)

ACTION	RESPONSE
1. Move A/C Control Wheel left and right, to sense its freedom of movement about roll axis.	-----
2. Set L/R Turn Knob located on bezel under its index.	-----
3. Engage stabilizer mode.	ST lamp alone is illuminated on AP display, as shown in Fig. 2-21.
4. Attempt movement of A/C Control Wheel left and right.	A/C Control Wheel's reduced freedom of movement indicates that Roll Servo is engaged. Roll Servo can be overridden. If not, disconnect autopilot and do not use.
5. Turn L/R Turn Knob to the left side of its index.	A/C Control Wheel turns to the left.
6. Turn L/R Turn Knob to the right side of its index.	A/C Control Wheel turns to the right.
7. Set L/R Turn Knob under its index.	A/C Control Wheel stops.
<p style="text-align: center;"><i>Note:</i></p> <p><i>If A/C is equipped with a heading system (HSI or DG), then proceed to step 8.</i></p> <p><i>If A/C is not equipped with a heading system, then proceed to step 13 only if a VOR frequency can be selected. Otherwise, proceed to step 26.</i></p>	

Table 2-5. Pre-Flight Test, System Thirty (continued from page 2-25)

ACTION	RESPONSE
8. Set Heading Bug under Lubber Line.	-----
9. Engage heading mode.	HD lamp alone is illuminated on AP display, as shown in Fig. 2-22.
10. Turn Heading Bug to the left side of Lubber Line.	A/C Control Wheel turns to the left.
11. Turn Heading Bug to the right side of Lubber Line.	A/C Control Wheel turns to the right.
12. Set Heading Bug under Lubber Line.	A/C Control Wheel stops.
<i>Note: If it is not possible to select a local VOR frequency on Navigation Receiver, then proceed to step 26. Otherwise, proceed to step 13.</i>	
13. Select local VOR frequency on Navigation Receiver.	-----
<i>Note: Proceed to either step 14 (HSI) or step 20 (DG).</i>	
14. Turn Course Pointer until CDI needle is centered.	-----
15. Engage low track mode.	LO TRK lamp alone is illuminated on AP display, as shown in Fig. 2-23.
16. Engage high track mode.	HI TRK lamp alone is illuminated on AP display, as shown in Fig. 2-24.
17. Turn Course Pointer left until CDI needle deflection is 2 dots right of center.	A/C Control Wheel turns to the right.



**Fig. 2-21. AP Display, ST Mode Engaged
(System Thirty)**



**Fig. 2-22. AP Display, HD Mode Engaged
(System Thirty)**

Table 2-5. Pre-Flight Test, System Thirty (continued from page 2-26)

ACTION	RESPONSE
18. Turn Course Pointer right until CDI needle deflection is 2 dots left of center.	A/C Control Wheel turns to the left.
19. Turn Course Pointer left until CDI needle is centered.	A/C Control Wheel stops.
<i>Note: Proceed to step 28.</i>	
20. Turn OBS until CDI needle is centered.	-----
21. Engage low track mode.	LO TRK lamp alone is illuminated on AP display, as shown in Fig. 2-23.
22. Engage high track mode.	HI TRK lamp alone is illuminated on AP display, as shown in Fig. 2-24.
23. Turn OBS until CDI needle deflection is 2 dots right of center.	A/C Control Wheel turns to the right.
24. Turn OBS until CDI needle deflection is 2 dots left of center.	A/C Control Wheel turns to the left.
25. Turn OBS until CDI needle is centered.	A/C Control Wheel stops.
<i>Note: Proceed to step 28.</i>	
26. Engage low track mode.	LO TRK lamp alone is illuminated on AP display, as shown in Fig. 2-23.
27. Engage high track mode.	HI TRK lamp alone is illuminated on AP display, as shown in Fig. 2-24.



Fig. 2-23. AP Display, LO TRK Mode Engaged (System Thirty)



Fig. 2-24. AP Display, HI TRK Mode Engaged (System Thirty)

Table 2-5. Pre-Flight Test, System Thirty (continued from page 2-28)

ACTION	RESPONSE
28. Move A/C Control Wheel forward and aft, to sense its freedom of movement about pitch axis.	-----
29. Engage altitude hold mode.	ALT lamp is illuminated on AP display, as shown in Fig. 2-25.
30. Attempt movement of A/C Control Wheel forward and aft.	A/C Control Wheel's reduced freedom of movement indicates that Pitch Servo is engaged. Pitch Servo can be overridden. If not, disconnect autopilot and do not use.
31. Move A/C Control Wheel as far forward as possible.	After 3 seconds, TRIM UP lamp becomes illuminated on AP display as shown in Fig. 2-26, and audible alert sounds a steady tone. After 7 seconds, TRIM UP lamp flashes and audible alert becomes periodic.
32. Move A/C Control Wheel aft until TRIM UP lamp is extinguished.	Audible alert is squelched.
33. Move A/C Control Wheel as far aft as possible.	After 3 seconds, TRIM DN lamp becomes illuminated on AP display as shown in Fig. 2-27, and audible alert sounds a steady tone. After 7 seconds, TRIM DN lamp flashes and audible alert becomes periodic.
34. Move A/C Control Wheel forward until TRIM DN lamp is extinguished.	Audible alert is squelched.



Fig. 2-25. AP Display, HI TRK and ALT HOLD Modes Engaged (System Thirty)



Fig. 2-26. AP Display, HI TRK and ALT HOLD Modes Engaged, TRIM UP Required (System Thirty)



Fig. 2-27. AP Display, HI TRK and ALT HOLD Modes Engaged, TRIM DN Required (System Thirty)

Table 2-5. Pre-Flight Test, System Thirty (continued from page 2-30)

ACTION	RESPONSE
<p>35. Disconnect autopilot by any one of the following means:</p> <p>a. Press optional AP DISC Switch typically located on Control Wheel.</p> <p>b. Press/Hold optional MODE SEL Switch typically located on Control Wheel for 3 seconds.</p> <p>c. Press/Hold PUSH MODE Switch located on bezel for 3 seconds.</p>	<p>RDY lamp flashes and audible alert sounds a periodic tone, while all other lamps are extinguished.</p> <p>After 5 seconds, RDY lamp stops flashing but remains illuminated, and audible alert is squelched.</p>
<p>36. Move A/C Control Wheel left and right.</p>	<p>A/C Control Wheel's increased freedom of movement indicates that Roll Servo is disengaged.</p>
<p>37. Move A/C Control Wheel forward and aft.</p>	<p>A/C Control Wheel's increased freedom of movement indicates that Pitch Servo is disengaged.</p>
<p><i>Note: If a Yaw Damper is installed, then proceed to step 38. Otherwise, proceed to step 47.</i></p>	
<p>38. Actuate A/C Rudder Pedals alternately in succession, to sense their freedom of movement about yaw axis.</p>	<p>-----</p>
<p>39. Set Yaw Damper Master Switch to ON position.</p>	<p>-----</p>
<p>40. Turn Yaw Trim Knob until A/C Rudder Pedals stop.</p>	<p>-----</p>

Table 2-5. Pre-Flight Test, System Thirty (continued from page 2-33)

ACTION	RESPONSE
41. Attempt actuation of A/C Rudder Pedals alternately in succession.	A/C Rudder Pedals' reduced freedom of movement indicates that Yaw Servo is engaged. Yaw Servo can be overridden. If not, set Yaw Damper Master Switch to OFF position, and do not use.
42. Turn Yaw Trim Knob fully CCW.	Left A/C Rudder Pedal slowly moves forward.
43. Turn Yaw Trim Knob fully CW.	Right A/C Rudder Pedal slowly moves forward.
44. Turn Yaw Trim Knob CCW until A/C Rudder Pedals stop.	-----
45. Set Yaw Damper Master Switch to OFF position.	-----
46. Actuate A/C Rudder Pedals alternately in succession.	A/C Rudder Pedals' increased freedom of movement indicates that Yaw Servo is disengaged.
47. Trim A/C for takeoff.	-----

2.2.3 System Thirty ALT

Prior to takeoff and with engine running, perform the actions shown in Table 2-6. For each action, verify the corresponding response where applicable.

Table 2-6. Pre-Flight Test, System Thirty ALT (continued on page 2-37)

ACTION	RESPONSE
1. Move A/C Control Wheel forward and aft, to sense its freedom of movement about pitch axis.	-----
2. Engage altitude hold mode.	ALT ON lamp is illuminated on ALT HOLD ON/OFF Switch display, as shown in Fig. 2-28.
3. Attempt movement of A/C Control Wheel forward and aft.	A/C Control Wheel's reduced freedom of movement indicates that Pitch Servo is engaged. Pitch Servo can be overridden. If not, disconnect autopilot and do not use.
4. Move A/C Control Wheel as far forward as possible.	After 3 seconds, UP lamp becomes illuminated on ALT HOLD ON/OFF Switch display as shown in Fig. 2-29, and audible alert sounds a steady tone. After 7 seconds, UP lamp flashes and audible alert becomes periodic.
5. Move A/C Control Wheel aft until UP lamp is extinguished.	Audible alert is squelched.
6. Move A/C Control Wheel as far aft as possible.	After 3 seconds, DN lamp becomes illuminated on ALT HOLD ON/OFF Switch display as shown in Fig. 2-30, and audible alert sounds a steady tone. After 7 seconds, DN lamp flashes and audible alert becomes periodic.



Fig. 2-28. ALT HOLD ON/OFF Switch Display, ALT HOLD Mode Engaged (System Thirty ALT)



Fig. 2-29. ALT HOLD ON/OFF Switch Display, ALT HOLD Mode Engaged, TRIM UP Required (System Thirty ALT)



Fig. 2-30. ALT HOLD ON/OFF Switch Display, ALT HOLD Mode Engaged, TRIM DN Required (System Thirty ALT)

Table 2-6. Pre-Flight Test, System Thirty ALT (continued from page 2-35)

ACTION	RESPONSE
7. Move A/C Control Wheel forward until DN lamp is extinguished.	Audible alert is squelched.
8. Disengage altitude hold mode.	ALT ON lamp is extinguished on ALT HOLD ON/OFF Switch display.
9. Move A/C Control Wheel forward and aft.	A/C Control Wheel's increased freedom of movement indicates that Pitch Servo is disengaged.
<i>Note: If a Yaw Damper is installed, then proceed to step 10. Otherwise, proceed to step 19.</i>	
10. Actuate A/C Rudder Pedals alternately in succession, to sense their freedom of movement about yaw axis.	-----
11. Set Yaw Damper Master Switch to ON position.	-----
12. Turn Yaw Trim Knob until A/C Rudder Pedals stop.	-----
13. Attempt actuation of A/C Rudder Pedals alternately in succession.	A/C Rudder Pedals' reduced freedom of movement indicates that Yaw Servo is engaged. Yaw Servo can be overridden. If not, set Yaw Damper Master Switch to OFF position, and do not use.
14. Turn Yaw Trim Knob fully CCW.	Left A/C Rudder Pedal slowly moves forward.
15. Turn Yaw Trim Knob fully CW.	Right A/C Rudder Pedal slowly moves forward.

Table 2-5. Pre-Flight Test, System Thirty ALT (continued from page 2-37)

ACTION	RESPONSE
16. Turn Yaw Trim Knob CCW until A/C Rudder Pedals stop.	-----
17. Set Yaw Damper Master Switch to OFF position.	-----
18. Actuate A/C Rudder Pedals alternately in succession.	A/C Rudder Pedals' increased freedom of movement indicates that Yaw Servo is disengaged.
19. Trim A/C for takeoff.	-----

SECTION 3 IN-FLIGHT PROCEDURES

Page Intentionally Blank

3.1 Normal Operating Procedures

3.1.1 Stabilizer (ST) Mode, System Twenty / Thirty

Set the L/R Turn Knob under its index, and then engage the stabilizer mode. The ST lamp alone will be illuminated as shown in Fig. 3-1, to acknowledge that this mode is engaged. The autopilot will hold the aircraft at wings level.

Turning the L/R Turn Knob to the left or right of its index will cause the aircraft to turn either left or right, respectively. The L/R Turn Knob is active only when the stabilizer mode is engaged.



Fig. 3-1. AP Display, ST Mode Engaged

3.1.2 Heading (HD) Mode, System Twenty / Thirty

Set the Heading Bug to the desired heading on the compass card (HSI or DG), and then engage the heading mode. The HD lamp alone will be illuminated as shown in Fig. 3-2, to acknowledge that this mode is engaged. The autopilot will turn the aircraft onto the selected heading and hold it. A new heading can be subsequently selected by setting the Heading Bug to it.



Fig. 3-2. AP Display, HD Mode Engaged

3.1.3 Low Track (LO TRK) Mode, System Twenty / Thirty

Select the VOR frequency on the Navigation Receiver. Maneuver the aircraft to within ± 1 CDI needle width and $\pm 10^\circ$ heading of the selected course. Engage the low track mode. The LO TRK lamp alone will be illuminated as shown in Fig. 3-3, to acknowledge that this mode is engaged. The autopilot will track the selected course with minimum authority, thereby ignoring short term CDI needle deflections (excursions) to inhibit aircraft scalloping during VOR station passage.



Fig. 3-3. AP Display, LO TRK Mode Engaged

3.1.4 High Track (HI TRK) Mode, System Twenty / Thirty

3.1.4.1 LOC Course Tracking

Select the LOC frequency on the Navigation Receiver. Maneuver the aircraft to within ± 1 CDI needle width and $\pm 10^\circ$ heading of the selected course. Engage the high track mode. The HI TRK lamp alone will be illuminated as shown in Fig. 3-4, to acknowledge that this mode is engaged. The autopilot will track the selected course with maximum authority.

3.1.4.2 GPS Course Tracking

Program a predefined course into the GPS Navigation Receiver, comprised of course segments connected by waypoints. Maneuver the aircraft to within ± 1 CDI needle width and $\pm 10^\circ$ heading of each successive course segment. Engage the high track mode. The HI TRK lamp alone will be illuminated as shown in Fig. 3-4, to acknowledge that this mode is engaged. The autopilot will track the selected course segment with maximum authority.

3.1.4.3 VOR Course Tracking

Select the VOR frequency on the Navigation Receiver. Maneuver the aircraft to within ± 1 CDI needle width and $\pm 10^\circ$ heading of the selected course. Engage the high track mode. The HI TRK lamp alone will be illuminated as shown in Fig. 3-4, to acknowledge that this mode is engaged. The autopilot will track the selected course with maximum authority. As a result, however, the aircraft may exhibit scalloping during VOR station passage.



Fig. 3-4. AP Display, HI TRK Mode Engaged

3.1.5 Altitude Hold (ALT HOLD) Mode, System Thirty / Thirty ALT

3.1.5.1 System Thirty

The altitude hold mode can only be engaged if a roll mode (ST, HD, LO TRK, HI TRK) is already engaged. Maneuver the aircraft to the desired altitude. Engage the altitude hold mode. The ALT lamp will be illuminated as shown in Fig. 3-5, to acknowledge that this mode is engaged. The autopilot will hold the aircraft at its current (captured) absolute pressure altitude.



Fig. 3-5. AP Display, ST and ALT HOLD Modes Engaged (System Thirty)

3.1.5.2 System Thirty ALT

Maneuver the aircraft to the desired altitude. Engage the altitude hold mode. The ALT ON lamp will be illuminated as shown in Fig. 3-6, to acknowledge that this mode is engaged. The autopilot will hold the aircraft at its current (captured) absolute pressure altitude.



Fig. 3-6. ALT HOLD ON/OFF Switch Display, ALT HOLD Mode Engaged (System Thirty ALT)

3.1.6 Manual Elevator Trim Prompts, System Thirty / Thirty ALT

3.1.6.1 System Thirty

If the altitude hold mode is engaged, then the autopilot will provide a prompt whenever it is necessary to manually trim the aircraft about the pitch axis using the Elevator Trim Wheel.

Should the pitch servo loading exceed a preset threshold for a period of three seconds, either the TRIM UP lamp or TRIM DN lamp will become illuminated, as a prompt to trim the aircraft in the indicated direction. This is shown in Fig. 3-7. In addition, an audible alert will sound a steady tone. If no action is taken after four more seconds, then the lamp will flash and the audible alert will become periodic. Once the aircraft has been sufficiently trimmed, such that the pitch servo loading is below the preset threshold, the lamp will extinguish and the audible alert will be squelched.

3.1.6.2 System Thirty ALT

If the altitude hold mode is engaged, then the autopilot will provide a prompt whenever it is necessary to manually trim the aircraft about the pitch axis using the Elevator Trim Wheel.

Should the pitch servo loading exceed a preset threshold for a period of three seconds, either the UP lamp or DN lamp will become illuminated, as a prompt to trim the aircraft in the indicated direction. This is shown in Fig. 3-8. In addition, an audible alert will sound a steady tone. If no action is taken after four more seconds, then the lamp will flash and the audible alert will become periodic. Once the aircraft has been sufficiently trimmed, such that the pitch servo loading is below the preset threshold, the lamp will extinguish and the audible alert will be squelched.



a. TRIM UP Required



b. TRIM DN Required

Fig. 3-7. AP Display, Manual Trim Prompts (System Thirty)



a. TRIM UP Required



b. TRIM DN Required

Fig. 3-8. ALT HOLD ON/OFF Switch Display, Manual Trim Prompts (System Thirty ALT)

3.2 Approach Procedures

3.2.1 Straight-In LOC Approach

3.2.1.1 Heading System DG

Select the LOC frequency on the Navigation Receiver. Set the Heading Bug to the FRONT INBOUND LOC heading, and then engage the heading mode. At the appropriate point, turn the Heading Bug to establish the aircraft on the FRONT INBOUND LOC course. Engage the high track mode. The autopilot will track the FRONT INBOUND LOC course.

A summary pictorial of this procedure is shown in Fig. 3-9.

3.2.1.2 Heading System HSI

Select the LOC frequency on the Navigation Receiver. For reference only, set the Course Pointer to the FRONT INBOUND LOC course. Set the Heading Bug to the FRONT INBOUND LOC heading, and then engage the heading mode. At the appropriate point, turn the Heading Bug to establish the aircraft on the FRONT INBOUND LOC course. Engage the high track mode. The autopilot will track the FRONT INBOUND LOC course.

A summary pictorial of this procedure is shown in Fig. 3-10.

3.2.2 Straight-In VOR Approach

3.2.2.1 Heading System DG

Select the VOR frequency on the Navigation Receiver. Set the OBS to the FRONT INBOUND VOR course. Set the Heading Bug to the FRONT INBOUND VOR heading, and then engage the heading mode. At the appropriate point, turn the Heading Bug to establish the aircraft on the FRONT INBOUND VOR course. Engage the high track mode. The autopilot will track the FRONT INBOUND VOR course.

A summary pictorial of this procedure is shown in Fig. 3-11.

3.2.2.2 Heading System HSI

Select the VOR frequency on the Navigation Receiver. Set the Course Pointer to the FRONT INBOUND VOR course. Set the Heading Bug to the FRONT INBOUND VOR heading, and then engage the heading mode. At the appropriate point, turn the Heading Bug to establish the aircraft on the FRONT INBOUND VOR course. Engage the high track mode. The autopilot will track the FRONT INBOUND VOR course.

A summary pictorial of this procedure is shown in Fig. 3-12.

S-TEC

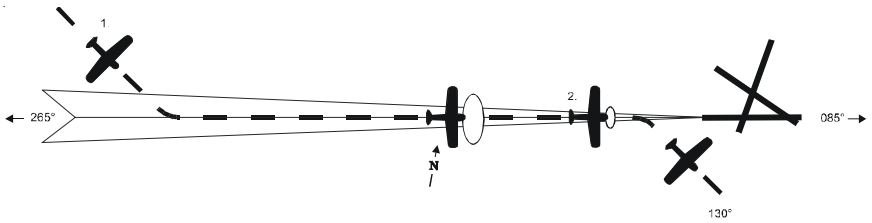

1. a. Select LOC frequency.
b. Set Heading Bug to FRONT INBOUND LOC heading.
c. Engage heading mode.
d. Turn Heading Bug to establish aircraft on FRONT INBOUND LOC course.
e. Engage high track mode.
f. Track FRONT INBOUND LOC course.
2. a. At middle marker, if missed approach is declared, disconnect autopilot.
b. Stabilize aircraft.
c. Set Heading Bug to missed approach heading.
d. Engage heading mode.

Fig. 3-9. Straight-In LOC Approach (DG)

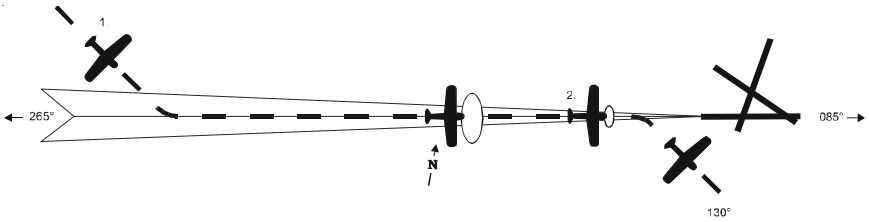

1.
 - a. Select LOC frequency.
 - b. Set Course Pointer to FRONT INBOUND LOC course (reference only).
 - c. Set Heading Bug to FRONT INBOUND LOC heading.
 - d. Engage heading mode.
 - e. Turn Heading Bug to establish aircraft on FRONT INBOUND LOC course.
 - f. Engage high track mode.
 - g. Track FRONT INBOUND LOC course.
2.
 - a. At middle marker, if missed approach is declared, disconnect autopilot.
 - b. Stabilize aircraft.
 - c. Set Heading Bug to missed approach heading.
 - d. Engage heading mode.

Fig. 3-10. Straight-In LOC Approach (HSI)

S-TEC

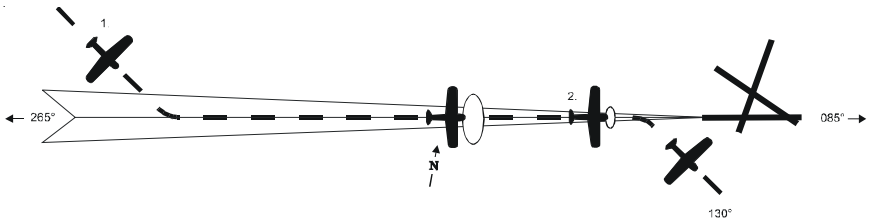

1. a. Select VOR frequency.
b. Set OBS to FRONT INBOUND VOR course.
c. Set Heading Bug to FRONT INBOUND VOR heading.
d. Engage heading mode.
e. Turn Heading Bug to establish aircraft on FRONT INBOUND VOR course.
f. Engage high track mode.
g. Track FRONT INBOUND VOR course.
2. a. At middle marker, if missed approach is declared, disconnect autopilot.
b. Stabilize aircraft.
c. Set Heading Bug to missed approach heading.
d. Engage heading mode.

Fig. 3-11. Straight-In VOR Approach (DG)

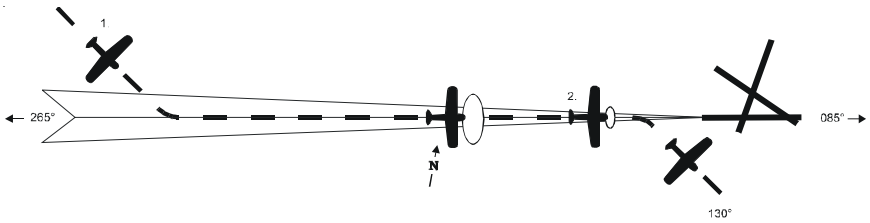

1.
 - a. Select VOR frequency.
 - b. Set Course Pointer to FRONT INBOUND VOR course.
 - c. Set Heading Bug to FRONT INBOUND VOR heading.
 - d. Engage heading mode.
 - e. Turn Heading Bug to establish aircraft on FRONT INBOUND VOR course.
 - f. Engage high track mode.
 - g. Track FRONT INBOUND VOR course.
2.
 - a. At middle marker, if missed approach is declared, disconnect autopilot.
 - b. Stabilize aircraft.
 - c. Set Heading Bug to missed approach heading.
 - d. Engage heading mode.

Fig. 3-12. Straight-In VOR Approach (HSI)

3.2.3 LOC Approach with Procedure Turn

3.2.3.1 Heading System DG

Select the LOC frequency on the Navigation Receiver. Set the Heading Bug to the FRONT OUTBOUND LOC heading, and then engage the heading mode. At the appropriate point, turn the Heading Bug to establish the aircraft on the FRONT OUTBOUND LOC course. At the appropriate point thereafter, set the Heading Bug to the FRONT OUTBOUND PROCEDURE TURN heading. Hold this heading until the point at which it is time to turn the aircraft again. At that point, turn the Heading Bug in two successive 90° increments, to establish the aircraft on the FRONT INBOUND PROCEDURE TURN heading. At the appropriate point, turn the Heading Bug to establish the aircraft on the FRONT INBOUND LOC course. Engage the high track mode. The autopilot will track the FRONT INBOUND LOC course.

A summary pictorial of this procedure is shown in Fig. 3-13.

3.2.3.2 Heading System HSI

Select the LOC frequency on the Navigation Receiver. For reference only, set the Course Pointer to the FRONT INBOUND LOC course. Set the Heading Bug to the FRONT OUTBOUND LOC heading, and then engage the heading mode. At the appropriate point, turn the Heading Bug to establish the aircraft on the FRONT OUTBOUND LOC course. At the appropriate point thereafter, set the Heading Bug to the FRONT OUTBOUND PROCEDURE TURN heading. Hold this heading until the point at which it is time to turn the aircraft again. At that point, turn the Heading Bug in two successive 90° increments, to establish the aircraft on the FRONT INBOUND PROCEDURE TURN heading. At the appropriate point, turn the Heading Bug to establish the aircraft on the FRONT INBOUND LOC course. Engage the high track mode. The autopilot will track the FRONT INBOUND LOC course.

A summary pictorial of this procedure is shown in Fig. 3-14.

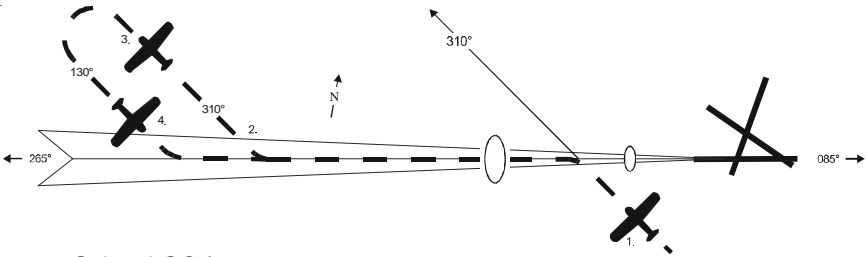

1. a. Select LOC frequency.
- b. Set Heading Bug to FRONT OUTBOUND LOC heading.
- c. Engage heading mode.
- d. Turn Heading Bug to establish aircraft on FRONT OUTBOUND LOC course.
2. a. Set Heading Bug to FRONT OUTBOUND PROCEDURE TURN heading.
3. a. Turn Heading Bug in two successive 90° increments, to establish aircraft on FRONT INBOUND PROCEDURE TURN heading.
4. a. Turn Heading Bug to establish aircraft on FRONT INBOUND LOC course.
- b. Engage high track mode.
- c. Track FRONT INBOUND LOC course.
5. a. At middle marker, if missed approach is declared, disconnect autopilot.
- b. Stabilize aircraft.
- c. Set Heading Bug to missed approach heading.
- d. Engage heading mode.

Fig. 3-13. LOC Approach with Procedure Turn (DG)

S-TEC

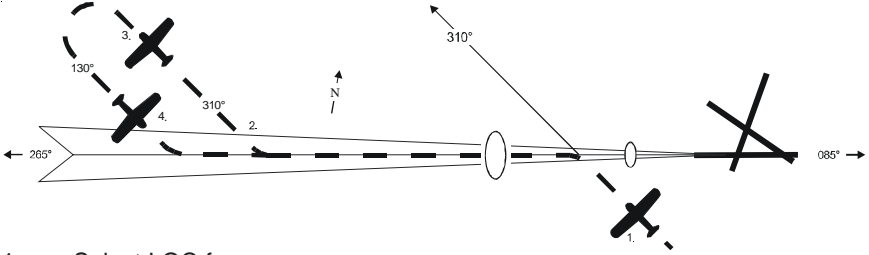

1. a. Select LOC frequency.
b. Set Course Pointer to FRONT INBOUND LOC course (reference only).
c. Set Heading Bug to FRONT OUTBOUND LOC heading.
d. Engage heading mode.
e. Turn Heading Bug to establish aircraft on FRONT OUTBOUND LOC course.
2. a. Set Heading Bug to FRONT OUTBOUND PROCEDURE TURN heading.
3. a. Turn Heading Bug in two successive 90° increments, to establish aircraft on FRONT INBOUND PROCEDURE TURN heading.
4. a. Turn Heading Bug to establish aircraft on FRONT INBOUND LOC course.
b. Engage high track mode.
c. Track FRONT INBOUND LOC course.
5. a. At middle marker, if missed approach is declared, disconnect autopilot.
b. Stabilize aircraft.
c. Set Heading Bug to missed approach heading.
d. Engage heading mode.

Fig. 3-14. LOC Approach with Procedure Turn (HSI)

3.2.4 VOR Approach with Procedure Turn

3.2.4.1 Heading System DG

Select the VOR frequency on the Navigation Receiver. Set the OBS to the FRONT INBOUND VOR course. Set the Heading Bug to the FRONT OUTBOUND VOR heading, and then engage the heading mode. At the appropriate point, turn the Heading Bug to establish the aircraft on the FRONT OUTBOUND VOR course. At the appropriate point thereafter, set the Heading Bug to the FRONT OUTBOUND PROCEDURE TURN heading. Hold this heading until the point at which it is time to turn the aircraft again. At that point, turn the Heading Bug in two successive 90° increments, to establish the aircraft on the FRONT INBOUND PROCEDURE TURN heading. At the appropriate point, turn the Heading Bug to establish the aircraft on the FRONT INBOUND VOR course. Engage the high track mode. The autopilot will track the FRONT INBOUND VOR course.

A summary pictorial of this procedure is shown in Fig. 3-15.

3.2.4.2 Heading System HSI

Select the VOR frequency on the Navigation Receiver. Set the Course Pointer to the FRONT INBOUND VOR course. Set the Heading Bug to the FRONT OUTBOUND VOR heading, and then engage the heading mode. At the appropriate point, turn the Heading Bug to establish the aircraft on the FRONT OUTBOUND VOR course. At the appropriate point thereafter, set the Heading Bug to the FRONT OUTBOUND PROCEDURE TURN heading. Hold this heading until the point at which it is time to turn the aircraft again. At that point, turn the Heading Bug in two successive 90° increments, to establish the aircraft on the FRONT INBOUND PROCEDURE TURN heading. At the appropriate point, turn the Heading Bug to establish the aircraft on the FRONT INBOUND VOR course. Engage the high track mode. The autopilot will track the FRONT INBOUND VOR course.

A summary pictorial of this procedure is shown in Fig. 3-16.

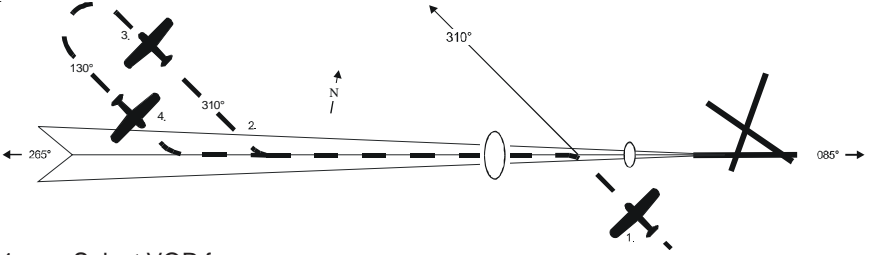

1. a. Select VOR frequency.
- b. Set OBS to FRONT INBOUND VOR course.
- c. Set Heading Bug to FRONT OUTBOUND VOR heading.
- d. Engage heading mode.
- e. Turn Heading Bug to establish aircraft on FRONT OUTBOUND VOR course.
2. a. Set Heading Bug to FRONT OUTBOUND PROCEDURE TURN heading.
3. a. Turn Heading Bug in two successive 90° increments, to establish aircraft on FRONT INBOUND PROCEDURE TURN heading.
4. a. Turn Heading Bug to establish aircraft on FRONT INBOUND VOR course.
- b. Engage high track mode.
- c. Track FRONT INBOUND VOR course.
5. a. At middle marker, if missed approach is declared, disconnect autopilot.
- b. Stabilize aircraft.
- c. Set Heading Bug to missed approach heading.
- d. Engage heading mode.

Fig. 3-15. VOR Approach with Procedure Turn (DG)

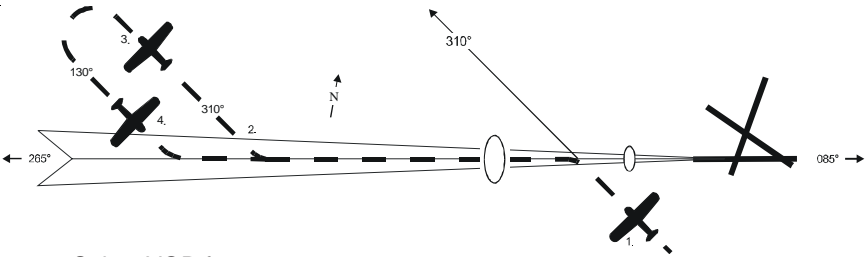

1. a. Select VOR frequency.
- b. Set Course Pointer to FRONT INBOUND VOR course.
- c. Set Heading Bug to FRONT OUTBOUND VOR heading.
- d. Engage heading mode.
- e. Turn Heading Bug to establish aircraft on FRONT OUTBOUND VOR course.
2. a. Set Heading Bug to FRONT OUTBOUND PROCEDURE TURN heading.
3. a. Turn Heading Bug in two successive 90° increments, to establish aircraft on FRONT INBOUND PROCEDURE TURN heading.
4. a. Turn Heading Bug to establish aircraft on FRONT INBOUND VOR course.
- b. Engage high track mode.
- c. Track FRONT INBOUND VOR course.
5. a. At middle marker, if missed approach is declared, disconnect autopilot.
- b. Stabilize aircraft.
- c. Set Heading Bug to missed approach heading.
- d. Engage heading mode.

Fig. 3-16. VOR Approach with Procedure Turn (HSI)

3.3 Yaw Damper Operation

The optional Yaw Damper serves to dampen excessive adverse yaw. It operates in either the AUTO mode or ON mode, depending upon the position of the Yaw Damper Master Switch shown in Fig. 3-17.

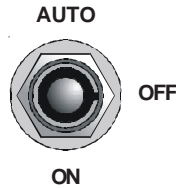

Fig. 3-17. Yaw Damper Master Switch

The Yaw Trim Knob, shown in Fig. 3-18, is used to center the slip/skid ball when the yaw servo is engaged.

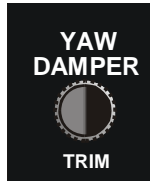

Fig. 3-18. Yaw Trim Knob

3.3.1 AUTO Mode

With the Yaw Damper Master Switch in the AUTO position, the yaw servo will become automatically engaged whenever a roll mode (ST, HD, LO TRK, HI TRK) is engaged.

3.3.2 ON Mode

With the Yaw Damper Master Switch in the ON position, the yaw servo will be engaged at all times, entirely independent of autopilot operation.

3.3.3 Yaw Damper Trim

With the yaw servo engaged, rotate the Yaw Trim Knob to center the slip/skid ball.

3.4 Autopilot Disconnect

3.4.1 System Twenty / Thirty

The autopilot can be disconnected by any of the following means:

1. Press optional AP DISC Switch typically located on Control Wheel.
2. Press/Hold optional MODE SEL Switch typically located on Control Wheel for 3 seconds.
3. Press/Hold PUSH MODE Switch located on bezel for 3 seconds.
4. Set Autopilot Master Switch to OFF position.
5. Pull Autopilot Circuit Breaker.

3.4.2 System Thirty ALT

The autopilot can be disconnected by any of the following means:

1. Press optional ALT ENG/DSNG Switch typically located on Control Wheel.
2. Press ALT HOLD ON/OFF Switch located on instrument panel.
3. Set ALT HOLD Master Switch to OFF position.
4. Pull ALT HOLD Circuit Breaker.

Page Intentionally Blank

SECTION 4 OPERATING PARAMETERS

Page Intentionally Blank

4.1 Roll Axis Limits

Turn Rate

Piston A/C:

90% Standard Rate Turn

Turboprop A/C:

75% Standard Rate Turn

4.2 Pitch Axis Limits

Altitude

32,000 FT

Vertical Force Due to Acceleration

0.60 g

Modes

For the System Thirty, the pitch mode (ALT HOLD) can only be engaged after a roll mode (ST, HD, LO TRK, HI TRK) has been engaged.

Page Intentionally Blank

SECTION 5 GLOSSARY

Page Intentionally Blank

Term	Meaning
A/C	Aircraft
ALT	Altitude
AP	Autopilot
CDI	Course Deviation Indication
CW	Clockwise
CCW	Counter-Clockwise
DG	Directional Gyro
DISC	Disconnect
DN	Down
DSNG	Disengage
ENG	Engage
FAA	Federal Aviation Administration
FT	Feet
GPS	Global Positioning System
HD	Heading
HI TRK	High Track
HSI	Horizontal Situation Indicator
IFR	Instrument Flight Rules
LO TRK	Low Track
LOC	Localizer
MAP	Missed Approach Point
OBS	Omnibearing Selector
PN	Part Number
POH	Pilot's Operating Handbook
RDY	Ready
ST	Stabilizer
UP	Up
VMC	Visual Meteorological Conditions
VOR	Very High Frequency Omnidirectional Radio Range

Page Intentionally Blank



Information contained in this document is subject to change without notice. © 2014 S-TEC. All rights reserved. Printed in the United States of America. S-TEC and the S-TEC logo are registered trademarks of S-TEC.

Notice:

Contact S-TEC Customer Support at 800-872-7832 for a Service Repair Order (SRO) number prior to the return of any component for any reason.

**One S-TEC Way
Municipal Airport
Mineral Wells, TX 76067-9236
Tel: 800-872-7832
Fax: 940-325-3904
www.genesys-aerosystems.com
S-TEC PN 8777**

MX385 NAV - COMM OWNER'S MANUAL



TKM, INC
14811 NORTH 73rd STREET SCOTTSDALE, AZ 85260

PART # MN0385, REV. 3
NOV 11, 1998

EQUIPMENT DESCRIPTION

The unit features digital (LED) displays for active (yellow) frequently channel and standby (red) frequency channel for both COMM and NAV.

For channel selection a MHz knob and a KHz knob are provided. For 25 KHz increments in COMM a 25 KHz button is provided. To activate COMM or NAV frequency selection an N/C button is provided; a 'Tic'* appears in the selected standby channel display.

Channel selection operates on the standby channel only. When the desired channel is indicated in the standby display it may be placed into the active position by depressing the "Flip-flop" button located to the left of the displays (labeled COMM and NAV); the active channel is then placed into the standby position.

The NAV receiver features a VC/ID button to permit selection of the voice or ident reception. In the Ident condition a 'Tic' is displayed on the active NAV channel display.

The COMM transceiver features a test button that overrides the squelch to verify proper receiver operation and to allow reception of weak signals. Also provided on the active COMM display is a 'Tic' to indicate transmitter power output.

The adjustment hole by the MHz switch permits operator adjustment of the display dimmer range for optimum nighttime brightness.

The adjustment hole by the KHz switch permits squelch adjustment and has a range of 10 db.

- The 'Tic' is the upper half of 'I' and is found to the left of the 100' s digit.

SPECIFICATIONS

Mounting:	Panel mounted, no shock mounting required.
Size:	6.22 x 2.60 x 12.6 inches w/ connectors.
Weight:	4.2 lbs. excluding external connector and harness.
Power Requirements:	27.5 Vcd
NAV and COMM Recv'r	0.7 A
Max COMM Total w/ Transmit (Tone)	3.7 A

COMM Transceiver

Crystal Controlled:	760 Channel
Frequency Range:	118.00 to 136.975 MHz
Frequency Stability:	+ I - .003%. -20 to 50C

Transmitter

VHF Power Output:	10 watts minimum. 50 ohm
Modulation:	85% capability with 90% limiting
Microphone:	Dynamic mike containing transistorized pre-amp or carbon (must provide at least 120 m Vrms into 500 ohm load).
Sidetone:	Adjustable up to 20 mw into 500 ohm headphones.
Duty Cycle:	1 minute on, 4 minutes off (20%).

COMM Receiver

Sensitivity:	-103 dbm will provide a 6 db minimum S + N/N (1 KHz. 30%)
Selectivity:	Typical 6 db at + I - 7.5 KHz. 45 db at + I - 17.5 KHz. 65 db at + I - 25 KHz.
Spurious Responses:	Down at least 70 db.
Squelch:	Noise adaptive squelch with manual override.
AGC Characteristics:	From -101 to -7 dbm audio output will not vary more than 1 db.

	<u>NA V Receiver</u>	
Crystal Controlled:		200 Channels
Frequency Range:		108.00 to 117.95 MHz
Sensitivity:		-107 dbm will provide at least half-flag indication.
Selectivity:		Typical 6 db at + <i>I</i> -15 KHz. 50 db at + <i>I</i> -35 KHz. 65 db at + <i>I</i> -50 KHz.
Spurious Responses:		Down at least 70 db.
Ident Filter:		15 db minimum
AGC Characteristics:		From -101 to -7 dbm audio output will not vary more than 1 db.
NA V Receiver Accuracy:		Two sigma limit. + <i>I</i> -1 degree.
NAV Output:		With LOC adjusted for 0.5 Vrms VOR = 0.71 Vrms (typical) into 20k ohms or greater load impedance.
DME Channeling:		2 x 5
G/S Channeling:		2 x 5
	<u>Audio</u>	
Auxiliary Audio Inputs:		Seven 500 ohm inputs with 30 db isolation. One high gain input.
Frequency Responses:		Within 6 db from 350 Hz to 2500 Hz
Headphone Output:		40 mw into 500 ohm.
Speaker Output:		1.5 Vrms into auxiliary input Produces 5 watts audio output.

EQUIPMENT LIMITATIONS

The following limitations indicate where the MX385 may be installed and meet the applicable TSO requirements.

1. Equipment is intended for installation within a nonpressurized but controlled temperature location in an aircraft that is operated at altitudes up to 35000 feet MSL.
2. Equipment is intended for use in a Standard Humidity Environment.
3. Equipment is intended to be panel mounted in single and Multi Engine Fixed Wing Aircraft with Reciprocating and Turbo propeller Engines.
4. Equipment shall not be mounted less than 0.3 m from magnetic compass.
5. Unit has not been tested with autopilots.

ASSOCIATED EQUIPMENT

The MX385 is designed to be a direct replacement for the ARC RT385 and RT 485 Units. The unit is dimensionally identical to the ARC units and can therefore use existing aircraft installations. The unit is electrically interchangeable with the ARC units and will provide the proper audio navigation signal and channeling signals for existing installations.

The remote channeling outputs of the unit-permit channeling of Glide Slope receivers and DME using 2x5 channeling codes

INSTALLATION

The MX385 is designed to be an exact replacement for the ARC RT385 and similar units. As a replacement unit the MX385 may be inserted directly into the mounting tray for the ARC unit and tightened down with a long (10" min) standard screwdriver.

To remove the MX385 from the mounting tray it is important to note that the Channel Selector knobs should not be used as handles. Using a long screwdriver, engage the clamp screw thru front panel access hole and rotate it CCW. The unit will be slowly retracted from the mounting tray and when the screw is completely disengaged the MX385 may be removed by sliding it out.

NOTICE TO INSTALLER

The TKM MX385 NAVICOMM is authorized by the FAA to TSO C34e, C36e, C37d, C38d, and C40c. The product is an incomplete system. In order to achieve a complete TSO quality system, the MX385 **must** be installed to configure in conjunction a TSO C37/C38 authorized antenna and a TSO C34 authorized navigation receiver. It is the responsibility of the installer to ensure proper installation.

CONTINUED AIRWORTHINESS (HBA 98-18)

Permission is hereby given to installers approved by the recognized aviation authority to reference relevant excerpts from the installation instructions provided by TKM, Inc. in order to fulfill documentation requirements for Instructions for Continued airworthiness. Adequacy of the documents should not be assumed by this permission. Responsibility for ICA documentation rests solely with the applicant. The MX385 product is 'Repair on Condition Only'.

OPERATING INSTRUCTIONS

Operating controls for the MX385 are located on the unit front panel or are remote inputs thru the rear panel.

The unit front panel is shown in figure 1. The left hand COMM readout indicates the active COMM frequency and the right hand COMM readout indicates the standby COMM frequency. The left hand NAV readout indicates the active NAV frequency and the right hand NAV readout indicates the standby NAV frequency. A 'Tic' readout is provided on the upper left hand corner of the first digit of each of the four frequency readouts.

The active COMM 'Tic' indicates the presence of transmitter power.

The standby COMM 'Tic' indicates that the Frequency Selection knobs will control COMM standby frequency.

The standby NAV 'Tic' indicates that the Frequency Selector knobs will control NAV standby frequency.

Power Application. The COMM volume control contains the master power switch and activates both the NAV and COMM functions internal to the MX385.

Frequency Selection. The N/C button is used to activate either the COMM or the NAV frequency selection as indicated by the appropriate 'Tic' display. The MHz and KHz controls can then be used to select a desired standby channel. In COMM the "25" button is used to advance the frequency by 25 KHz.

After the desired standby frequency is selected it may be transferred to the active position by pressing the flip-flop button to the left of the ACTIVE display. The active and standby channels will be interchanged each time the button is pressed.

Ident/Voice Selection. The ID/VD button can be used to select a tone filter in order to receive voice signals on the NAV receiver. The switch is also used for frequency storage as described below.

Test. The TEST button is a dual function switch. In normal operation it is used to override the squelch to verify receiver operation and to receive weak signals. The switch is also used for frequency storage as described below.

VT. The VT button is used to test external equipment if the installation has been wired for that function.

Preset Frequency Operation

To erase all frequency presets with one operation simply turn on the power to the radio while holding the TEST button depressed.

Examining/Changing/Inserting/Deleting Frequency Presets

The operation on individual frequency presets is accomplished in EDIT mode. To enter EDIT mode turn on the power to the radio while holding the VT button depressed. When the radio

is in EDIT mode the ACTIVE displays show the reference number of the preset and the STBY displays show the actual preset frequency. After a CLEAR operation as described above, the only presets will be the default of 112.0

EDIT mode operations are performed on either the COMM or NAV preset list according to where the tuning tic indicator is displayed. The tuning tic appears immediately to the left of the COMM or NAV between NAV and COMM preset editing.

Examining Presets (EDIT Mode)

Pressing the COMM button will step to the next frequency in the preset list. Pressing the TEST button will step to the previous frequency in the preset list. Pressing COMM when the last preset is displayed will cause the first preset to display. Similarly pressing TEST when the first preset is displayed will cause the last preset to display. WARNING:

When there is only one preset in the list the radio will not appear to "do anything" when COMM or TEST is pressed. This is because the current, previous, and next presets are all the same preset.

Changing a Preset (Edit Mode)

Press COMM or TEST until the desired insert point is displayed (the new preset will be inserted AFTER this insert point). Dial in the desired frequency using the tuning controls and press NAV. Remember that a preset list may contain a maximum of 50 entries. Insert commands that would cause this limit to be exceeded are ignored.

Deleting a Preset (Edit Mode)

Press COMM or TEST until the preset to be deleted is displayed, then press the VCID switch to delete. If the deleted preset was not at the end of the list all the presets that followed it are renumbered. Each preset list (NAV and COMM) must always contain at least one entry. If there is only one entry remaining in a preset list it may not be deleted (it can be changed to another frequency).

Frequency Preset, Normal Operation

At any time the radio is in normal operation (Not EDIT MODE) COMM preset frequencies may be called into the STDBY frequency display by pressing COMM while the TEST button is depressed. During the time that both buttons are held simultaneously depressed the reference number for the preset appears in the ACTIVE window. Each time this operation is repeated it will copy the "next" preset to the COMM STDBY frequency.

NAV preset operation is similar with the exception that presets are retrieved by pressing NAV while the VC - ID button is depressed.

Dimmer

Display Dimmer Adjustment The dark end of the automatic display dimmer range is adjustable through the front panel hole by the MHz switch marked "D".

ENVIRONMENTAL QUALIFICATIONS FORM

MODEL MX385 NAV I COMM as specified in MX385 Specifications is manufactured by TKM, INC., 14811 NORTH 73rd STREET, SCOTTSDALE, AZ 85260.

CONDITIONS	D0160C para	DESCRIPTION OF TEST
Temperature and Alt.	4.0	Category C1
Low Temperature	4.5.1	Category C1
High Temperature	4.5.2	Category C1
Altitude	4.6.1	Category C1
Decompression	4.6.2	Not Tested
Overpressure	4.6.3	Not Tested
Temperature Variation	5.0	Category C
Humidity	6.0	Category A
Shock	7.0	Tested for all condo
Vibration	8.0	Category M/N (no shock mts).
Explosion	9.0	X: Not Tested
Waterproof	10.0	X: Not Tested
Fluid Susceptibility	11.0	X: Not Tested
Sand and Dust	12.0	X: Not Tested
Fungus	13.0	X: Not Tested
Salt Spray	14.0	X: Not Tested
Magnetic Effect	15.0	Category A
Power Input	16.0	Category B
Voltage Spike Condo	17.0	Category B
Audio Cond. Suscept.	18.0	Category B
Induced Sig. Susceptibility	19.0	Category B
RF Susceptibility	20.0	Category T

RF Emission	21.0	Category B
Lightning Susceptibility	22.0	X: Not Tested

Installation Note: The MX385 is designed to be a slide in replacement for ARC radios and as such, shall be installed with all of the original equipment precautions.



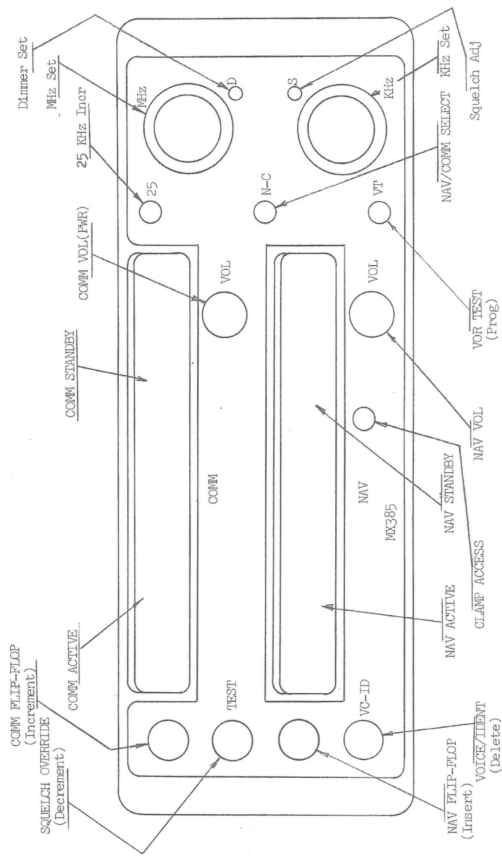

Figure 1 M0385 Front Panel

MX385 Interconnect

The following table lists the pin description for the MX385 interconnects.

J1

Pin #	Description	Pin #	Description
1	Phn sidetone in	14	Phn sidetone out
2	Isol. Audio input	15	Speaker
3	Spare	16	Speaker
4	Aux audio input	17	Mic key
5	Aux audio input	18	Comm phn audio
6	Aux audio input	19	Sidetone out
7	Aux audio input	20	+ 28v audio
8	Aux audio input	21	Comm phn audio
9	NA V audio input	22	+ 28v comm
10	COMM audio input	23	+ 28v nav
11	Ground	24	Ground
12	Spare	25	Spare
13	Mic audio input	26	Spare

J2

Description	Pin #	Computer Board Pin #
DME Common	33	32
DME 1 MHz A	14	22
DME 1 MHz B	13	19
DME 1 MHz C	28	17
DME 1 MHz D	29	20
DME 1 MHz E	30	23
DME 100 KHz A	32	20
DME 100 KHz B	50	33
DME 100 KHz C	11	13
DME 100 KHz D	17	31
DME 100 KHz E	12	16
DME 50 KHz	31	26
GS Common	26	11
GS 1 MHz A	25	9
GS 1 MHz B	39	7
GS 1 MHz C	43	12
GS 1 MHz D	44	15
GS 1 MHz E	48	27
GS 100 KHz A	46	21
GS 100 KHz B	45	18
GS 100 KHz C	27	14
GS 100 KHz D	16	28
GS 100 KHz E	49	30
GS 50 KHz	47	24
ILS Enable	15	25
Nav Composite	18	2
NAVPhone	1	1
+28v Switched	37	5
NAV test	41	8
COMM flip-flop	10	10
Ground	4	3
Ground	21	4
Ground	38	6

GARMIN Ltd. or its subsidiaries
c/o GARMIN International, Inc.
1200 E. 151st Street
Olathe, Kansas 66062 U.S.A.

FAA Approved
AIRPLANE FLIGHT MANUAL SUPPLEMENT
or
SUPPLEMENTAL AIRPLANE FLIGHT MANUAL
for the
GARMIN G5 ELECTRONIC FLIGHT INSTRUMENT
as installed in

Cessna B172K
Make and Model Airplane

Registration Number: N758RL Serial Number: B1723299

This document serves as an Airplane Flight Manual Supplement or as a Supplemental Airplane Flight Manual when the aircraft is equipped in accordance with Supplemental Type Certificate SA01818WI for the installation and operation of the Garmin G5 Electronic Flight Instrument. This document must be carried in the airplane at all times.

The information contained herein supplements or supersedes the information made available to the operator by the aircraft manufacturer in the form of clearly stated placards or markings, or in the form of an FAA approved Airplane Flight Manual, only in those areas listed herein. For limitations, procedures and performance information not contained in this document, consult the basic placards or markings, or the basic FAA approved Airplane Flight Manual.

FAA APPROVED BY: David G. Armstrong

David G. Armstrong
ODA STC Unit Administrator
GARMIN International, Inc
ODA-240087-CE

DATE: 7/19/19

© Copyright 2019
Garmin Ltd. or its subsidiaries
All Rights Reserved

Except as expressly provided herein, no part of this manual may be reproduced, copied, transmitted, disseminated, downloaded or stored in any storage medium, for any purpose without the express prior written consent of Garmin. Garmin hereby grants permission to download a single copy of this manual and of any revision to this manual onto a hard drive or other electronic storage medium to be viewed and to print one copy of this manual or of any revision hereto, provided that such electronic or printed copy of this manual or revision must contain the complete text of this copyright notice and provided further that any unauthorized commercial distribution of this manual or any revision hereto is strictly prohibited.

Garmin International, Inc.
1200 E. 151st Street
Olathe, KS 66062 USA
Telephone: 913-397-8200
www.garmin.com

Garmin International, Inc

Log of Revisions

FAA Approved AIRPLANE FLIGHT MANUAL SUPPLEMENT

or

SUPPLEMENTAL AIRPLANE FLIGHT MANUAL
GARMIN G5 ELECTRONIC FLIGHT INSTRUMENT

REV NO.	PAGE NO(S)	DESCRIPTION	DATE OF APPROVAL	FAA APPROVED
1	ALL	Original Issue	7/22/2016	Robert Murray ODA STC Unit Administrator
2	ALL	Added information regarding G5 DG/HSI.	4/28/2017	Robert Murray ODA STC Unit Administrator
3	ALL	Added interface to 3 rd party autopilots.	10/18/2017	Robert Murray ODA STC Unit Administrator
4	ALL	Added note to General section.	10/26/17	Paul Mast ODA STC Unit Administrator
5	ALL	Reformatted document. Updated system messages interface. Added DG/HSI reversion description.	12/20/17	Robert Murray ODA STC Unit Administrator
6	ALL	Added interface description to GAD 13. Added information regarding multiple NAV source inputs.	See Cover	See Cover

This page intentionally left blank.

Table of Contents

Section 1 – General	1-1
Abbreviations and Terminology	1-2
Section 2 – Limitations	2-1
System Software Requirements	2-1
Use of Secondary Instruments	2-1
Kinds of Operations	2-1
Section 3 – Emergency Procedures	3-1
G5 Failure Indications	3-1
Attitude Failure	3-1
Heading Failure, Loss of Magnetometer Data, or Magnetic Field Error	3-1
GPS Failure	3-2
Attitude Aligning	3-2
Attitude Aligning / Keep Wings Level	3-2
Loss of Electrical Power to the G5 Display	3-2
Loss of Electrical Power to the GAD 29B (If Installed)	3-3
Loss of Electrical Power to the GAD 13 (If Installed)	3-3
Section 4 – Normal Procedures	4-1
G5 Power Button and Knob	4-1
Backlight Intensity Adjustment	4-1
Prior to Flight in Instrument Meteorological Conditions	4-1
Autopilot Operations with the G5 HSI	4-2
Course / NAV Selection Coupling to the Autopilot (If Configured)	4-2
Heading Bug Coupling Capability to the Autopilot (If Configured)	4-2
Roll Steering (GPSS) Emulated via HDG Mode (If Configured)	4-2
HSI Source Selection (If Configured)	4-3
Section 5 – Performance	5-1
Section 6 – Weight and Balance	6-1
Section 7 – System Description	7-1
System Messages	7-1

This page intentionally left blank.

SECTION 1 – GENERAL

The G5 Electronic Flight Instrument can display the following information to the pilot depending on the installation and location of the G5 instrument.

- Primary attitude
- Primary slip and turn rate information
- Primary heading
- Secondary airspeed
- Secondary altimeter
- Secondary ground track

When installed in place of the attitude indicator, the primary function of the G5 is to provide attitude information to the pilot. When installed in place of the rate of turn indicator, the primary function of the G5 is to provide turn rate and slip ball information to the pilot. When installed in place of the directional gyro, the primary function of the G5 is to provide directional information to the pilot.

NOTE:

The pilot is reminded to perform appropriate flight and navigation instrument cross checks for the type of operation being conducted.

In case of a loss of aircraft electrical power, a backup battery (optional when installed as a DG/HSI) sustains the G5 Electronic Flight Instrument for up to four hours.

An optional GAD 29B may be installed to provide course and heading datum to an autopilot based on the data selected for display on the HSI.

An optional GAD 13 and OAT probe may be installed to provide measured outside air temperature (OAT) to the G5 for display of true airspeed (TAS), outside air temperature, winds, and density altitude.

This STC allows the removal of the aircraft's vacuum system if it is not required to support any other airframe system.

Abbreviations and Terminology

The following glossary is applicable within the airplane flight manual supplement

ADI	Attitude Direction Indicator
AFMS	Airplane Flight Manual Supplement
ATT	Attitude
CDI	Course Deviation Indicator
DG	Directional Gyro
DR	Dead Reckoning
FAA	Federal Aviation Administration
GPS	Global Positioning System
GPSS	GPS Roll Steering
HDG	Heading
HSI	Horizontal Situation Indicator
ILS	Instrument Landing System
LOC	Localizer (no glideslope available)
LOI	Loss of Integrity
OAT	Outside Air Temperature
TAS	True Airspeed
VFR	Visual Flight Rules
VHF	Very High Frequency
VOR	VHF Omni-directional Range

SECTION 2 – LIMITATIONS

System Software Requirements

The G5 must utilize the following or later FAA approved software versions for this AFMS revision to be applicable:

Component	Software Version
G5 Electronic Flight Instrument	6.20

Use of Secondary Instruments

The original type design approved instruments for airspeed, altitude and vertical speed remain the primary indications for these parameters.

If the G5 Electronic Flight Instrument is installed in place of the rate of turn indicator, the original type design approved instrument for attitude remains in the primary indication for attitude.

If the G5 Electronic Flight Instrument is installed in place of the directional gyro, the original type design approved instruments for attitude remains the primary indication for attitude.

NOTE:

For aircraft approved for VFR-only operations, the G5 Electronic Flight Instrument may be installed as an attitude indicator and rate of turn indicator.

Kinds of Operations

No Change except for the following:

- When a portable navigation source is selected on the G5, it shall not be used for the primary means of navigation for IFR operations.

This page intentionally left blank.

SECTION 3 – EMERGENCY PROCEDURES

G5 Failure Indications

If a G5 function fails, a large red 'X' is typically displayed over the instrument(s) or data experiencing the failure. Upon G5 power-up, certain instruments remain invalid as equipment begins to initialize. All instruments should be operational within one minute of power-up. If any instrument remains flagged and it is not likely an installation related problem, the G5 should be serviced by a Garmin-authorized repair facility.



Attitude Failure

Attitude failure is indicated by removal of the sky/ground presentation, a red X, and a yellow "ATTITUDE FAIL" on the display.

Rate-of-turn and slip information will not be available.

1. Use standby instruments.
2. Seek VFR conditions or land as soon as practical.

Heading Failure, Loss of Magnetometer Data, or Magnetic Field Error

A heading failure, loss of magnetometer data, or magnetic field error is indicated by removal of the digital heading readout, a red X, and a yellow "HDG" on the display.

1. Use standby magnetic compass.

NOTE:

If the G5 DG/HSI has a valid GPS signal the G5 DG/HSI instrument will display the GPS track information in magenta.

GPS Failure

If GPS navigation receivers and/or navigation information are not available or invalid, the G5 will display Dead Reckoning mode (DR) or Loss of Integrity mode (LOI) on the HSI in the lower left corner.

If Alternate Navigation Sources (ILS, LOC, VOR) Are Available:

1. Use alternate navigation source.

If No Alternate Navigation Sources Are Available:

If DR is Displayed on HSI:

1. Use the amber CDI for course information.
2. Fly toward known visual conditions.

If LOI is Displayed on HSI:

1. Fly toward known visual conditions.

For aircraft equipped with a GAD 29B interfaced to an autopilot, GPSS will be displayed in amber text when GPSS emulation has been selected from the G5 menu.

1. Deselect GPSS from the G5 menu and select a different autopilot mode.

Attitude Aligning

During system initialization, the G5 displays the message 'ALIGNING' over the attitude indicator. The G5 will typically display valid attitude within the first minute of power-up. The G5 can also align itself while taxiing and during level flight.

If the "ALIGNING" indication occurs during flight and attitude remains displayed, the attitude display is acceptable for use for flight in instrument conditions. The message will clear when the attitude solution is within the systems internal accuracy tolerances. It is recommended to maintain wings level to reduce the time for the system to align.

Attitude Aligning / Keep Wings Level

If the "ALIGNING KEEP WINGS LEVEL" indication occurs during flight, the G5 has detected an invalid attitude solution and will not display any attitude information.

1. Use standby instruments to maintain wings level flight. The system will display attitude when internal accuracy tolerances have been met.
2. If attitude does not return, seek VFR conditions or land as soon as practical.

Loss of Electrical Power to the G5 Display

In the event of a loss of aircraft electrical power to the G5 attitude display, the indicator will continue to function on its internal battery. If an internal battery is installed on the optional G5 HSI, the indicator will continue to function on the internal battery if aircraft power is lost. Internal battery endurance is indicated on the G5 display in hours and minutes. The charging symbol will be removed and the internal battery will not be charged.

In the event the G5 attitude display powers down, the optional G5 HSI will automatically revert to displaying attitude information. It will not revert back to the DG/HSI format if the G5 attitude unit regains power. The DG/HSI presentation may be selected from the G5 menu on the G5 DG/HSI unit after reversion to the attitude display.

Loss of Electrical Power to the GAD 29B (If Installed)

In the event of a loss of aircraft electrical power to the optional GAD 29B, the heading and course datum will be unavailable to the autopilot and the autopilot may deviate from the intended path or may disconnect. GPS flight plan course information may be displayed on the HSI and VFR will be displayed in amber text on the HSI. GPSS will be displayed in amber text, if GPSS mode is selected.



1. Deselect GPSS from the G5 menu and select a different autopilot mode.
2. Lateral GPS course guidance may only be used in VFR conditions.

Loss of Electrical Power to the GAD 13 (If Installed)

In the event of a loss of aircraft electrical power to the optional GAD 13, the OAT and TAS indications will be replaced with a red X. The Density Altitude indication will be removed, and "No Wind Data" will be displayed in the wind field.



1. Use an alternate source of outside air temperature to calculate true airspeed, density altitude, and winds.

This page intentionally left blank.

SECTION 4 – NORMAL PROCEDURES

G5 Power Button and Knob

The G5 display will power on with the application of aircraft power. The G5 power button is used to turn the display on and off. Press and hold the power button to turn the display off.

The knob performs the following functions:

Press	Press to access the Menu. From the Menu, press to select the desired menu item. Press to accept the displayed value when editing numeric data or selecting from a list. Press to sync the heading or track bug for the HSI.
Turn	From the Menu, turn the Knob to move the cursor to the desired menu item. For the ADI, rotate to adjust the baro setting on the secondary altitude display. For the HSI, rotate to adjust the heading or track bug. Turn to select the desired value when editing numeric data or selecting from a list.

Backlight Intensity Adjustment

The power up state of the G5 backlight is in Auto adjustment mode.

To adjust the backlighting:

To select Manual mode from Auto mode:

1. While the unit is turned on, press the Power button.
2. Turn the knob to manually adjust the backlight intensity.
3. Press the knob to close the backlight page.

To select Auto mode from Manual mode:

1. While the unit is turned on, press the Power button.
2. Press the Power button again to select Auto.
3. Press the knob to close the backlight page.

Prior to Flight in Instrument Meteorological Conditions

1. Press the Power button on the G5 attitude indicator.
2. Verify the battery status indicator is green on the G5 attitude indicator.

Autopilot Operations with the G5 HSI

The G5 and optional GAD 29B offer various integration capabilities dependent upon the type of autopilot installed in a particular aircraft.

The G5 Electronic Flight Instrument installation in this aircraft provides the following autopilot functions (appropriate boxes will be checked):

- This installation does not interface with the autopilot (basic wing leveling autopilot or no autopilot is installed in the aircraft).
 - A GAD 29B Adapter is installed in this aircraft.
 - Course / NAV Selection coupling to the autopilot.
 - Heading Bug coupling capability to the autopilot.
 - Roll Steering (GPSS) emulated via heading mode.
- OR
- Roll Steering capable autopilot (GPSS menu function for emulation not applicable).

Course / NAV Selection Coupling to the Autopilot (If Configured)

When operating the autopilot in NAV mode, the deviation information from the installed navigation sources (i.e. GPS or NAV) is switched via the navigation source. The NAV source displayed on the HSI is the NAV source the autopilot is following. Many autopilots also use the course datum to determine the best intercept angles when operating in NAV mode.

Heading Bug Coupling Capability to the Autopilot (If Configured)

When operating the autopilot in HDG mode, the difference between the HDG bug location on the HSI and the actual aircraft heading creates an error signal which the autopilot will minimize by turning in the direction of the bug. If the bug is turned more than 180 degrees, the autopilot may turn the airplane in the opposite direction of the desired turn.

Roll Steering (GPSS) Emulated via HDG Mode (If Configured)

For autopilots that do not support digital GPSS signals, GPSS functionality may be emulated by operating the autopilot in HDG mode and selecting GPSS from the G5 menu. If the autopilot is already designed to receive roll steering information, the data is transmitted digitally from the navigator to the autopilot.

When GPSS is selected on the G5 menu, the heading bug on the HSI changes to a hollow outline and a crossed-out heading bug appears on the G5 HSI display indicating that the autopilot is not coupled to the heading bug. The bug is still controllable and may still be used for reference.



When GPSS is selected on the G5, GPSS turn commands are converted into a heading error signal to the autopilot. When the autopilot is operated in HDG mode, the autopilot will fly the turn commands from the GPS

navigator. If the GPSS data is invalid (for example, if there is no active GPS leg) or the selected HSI source on the G5 HSI is not GPS, the annunciated GPSS text will be yellow and a zero turn command will be sent to the autopilot.

HSI Source Selection (If Configured)

For aircraft configured with two navigation inputs to the G5, the desired source may be selected using the G5 knob and menu selection. Press the G5 knob to cycle between the NAV1 and NAV2 input.



HSI Portable Navigation Device GPS VFR Annunciation (If Configured)

For aircraft configured for a portable navigation device input to the G5, a GPS VFR indicated in magenta will be displayed on the HSI. When the G5 with a portable navigation device is interfaced there is not enough guidance data for IFR use.



This page intentionally left blank.

SECTION 5 – PERFORMANCE

No change.

This page intentionally left blank.

SECTION 6 – WEIGHT AND BALANCE

See current weight and balance data.

This page intentionally left blank.

SECTION 7 – SYSTEM DESCRIPTION

Refer to Garmin G5 Electronic Flight Instrument Pilot's Guide for Certified Aircraft, part number 190-01112-12 Rev A (or later approved revisions), for a description of the G5 electronic flight instrument. This reference material is not required to be on board the aircraft but does contain a more in depth description of all the functions and capabilities of the G5.

The ATT circuit breaker supplies power to the G5 instrument for normal power operation and to charge the internal battery.

The DG circuit breaker supplies power to the G5 instrument for normal power operation when configured as a DG, and to charge the internal battery (if installed).

The HSI circuit breaker supplies power to the G5 instrument for normal power operation when configured as an HSI, and to charge the internal battery (if installed).

The GAD circuit breaker supplies power to the optional GAD 29 adapter and optional GAD 13 adapter for normal power operation.

System Messages

The G5 has the capability to display system messages to the crew along the bottom of the display. A system message is indicated through a white  indication on the G5.

Messages can be displayed by pressing the G5 knob, and selecting the Message menu item.

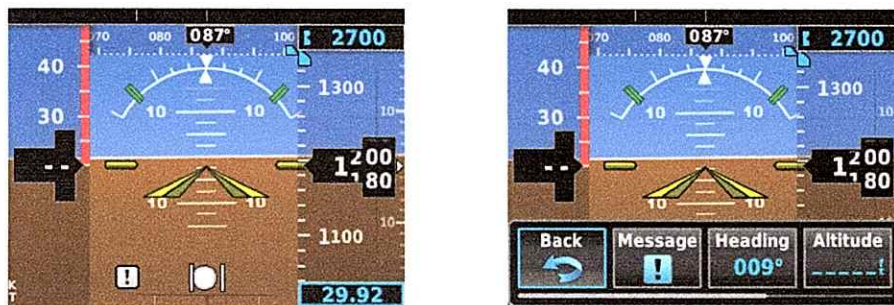

(For Reference Only)

The following table shows the meaning of each message. System messages are displayed in white text.

Message	Meaning
External Power Lost	Aircraft power has been removed from the G5.
Critical battery fault! Powering off	Battery has critical fault condition and the unit is about to power off to avoid damage to the battery.
Battery fault	Battery has a fault condition – unit needs service.
Battery charger fault	Battery charger has a fault condition – unit needs service.
Low battery	Battery charge level is low.
Hardware fault	Unit has a hardware fault – unit needs service.
Power supply fault	Unit power supply fault detected – unit needs service.
Unit temperature limit exceeded	Unit is too hot or too cold.
Network address conflict	Another G5 with the same address is detected on the network (most commonly a wiring error on one of the units).
Communication error	General communication error (most commonly appears in conjunction with Network Address Conflict message).
Factory calibration data invalid	Unit calibration data not valid – unit needs service.
Magnetic field model database out of date	Internal magnetic field database is out of date - software update required.
Magnetometer Hardware fault	The magnetometer has detected a fault – unit needs service. Heading data may not be available.
Using external GPS data	GPS data from another network LRU is being used. The unit's internal GPS receiver is enabled, but unable to establish a GPS fix.
Not receiving RS-232 data	The G5 is not receiving RS-232 data from the GPS navigator – system needs service.
Not receiving ARINC 429 data	The G5 is not receiving ARINC 429 data from the navigation source – system needs service.
GPS receiver fault	The G5 on-board GPS receiver has a fault.
ARINC 429 interface configuration error	The G5 ARINC 429 port is receiving information from an incorrect source – system needs service.
Software version mismatch	The G5 attitude indicator and the G5 HSI units have different software. Cross fill of baro, heading and altitude bugs is disabled.

These messages remain while the condition persists.